



IGB Austria

ALL Glock Models & Gen
1911 / CZ / HK / Sig Sauer / Steyr / S&W ...
All Lengths
Various Calibers
ALL In-House

BARREL

TECHNOLOGY

Inh. Viktor Schranz

Gärtnergasse 15

A-2251 Ebenthal

Tel : +43 (0) 2538 87378

E-Mail: info@igbaustria.com

Overview / Inhaltsverzeichnis

- P. 4 GLOCK
 - P. 4 G17 9x19 Gen. 2- Gen. 4
 - P. 7 G17 9x19 Gen. 5
 - P. 10 .22lr Conversion Set
 - P. 11 G19 9x19 Gen. 2- Gen. 5
 - P. 15 G20 10 Auto
 - P. 18 G21 .45 ACP
 - P. 22 G22 40 S&W Gen. 2- Gen. 4
 - P. 25 G22 40 S&W Gen. 5
 - P. 29 G23 40 S&W Gen. 2- Gen. 4
 - P. 32 G23 40 S&W Gen. 5
 - P. 35 G24 40 S&W
 - P. 39 G25 .380
 - P. 40 G26 9x19
 - P. 42 G27 40 S&W
 - P. 45 G28 .380
 - P. 46 G29 10 Auto
 - P. 48 G30 .45 ACP
 - P. 51 G31 .357 Sig
 - P. 54 G32 .357 Sig
 - P. 57 G33 .357 Sig
 - P. 60 G34 9x19 Gen.2 – Gen.4
 - P. 63 G34 9x19 Gen. 5
 - P. 67 G35 .40 S&W
 - P. 70 G36 45 ACP
 - P. 72 G40 10 Auto
 - P. 75 G41 45 ACP
 - P. 78 G42 .380
 - P. 80 G43 9x19
 - P. 81 G45 9x19
 - P. 85 G48 9x19
- P. 87 CZ
 - P. 88 CZ 75 - 9x19
 - P. 90 CZ 75B - 9x19
 - P. 92 CZ SP01 - 9x19
 - P. 94 CZ SHADOW 1 & 2 - 9x19
 - P. 96 CZ Tactical Sport - 9x19
 - P. 98 CZ Tactical Sport - .40 S&W
 - P. 100 CZ Sport 2 - 9x19
 - P. 101 CZ Viper & Mamba - 9x19
 - P. 102 CZ P07 - 9x19
- P. 105 S&W
 - P. 106 S&W M&P 9 - 9x19
 - P. 108 S&W M&P 9 M2.0- 9x19

IGB BARRELS FOR GLOCK

- P. 111 Sig Sauer
 - P. 112 P226 9x19
 - P. 114 P226 40 S&W
 - P. 116 P226 X5 9x19
 - P. 118 P226 X5 .40 S&W
 - P. 120 P226 X6 9x19
 - P. 123 P320 9x19
 - P. 125 P320 Compact 9x19
 - P. 128 P220 .45 acp
 - P. 129 P226 LCD
 - P. 129 P228
 - P. 129 P229
 - P. 129 P365
 - P. 129 P220 X6
 - P. 129 P220 Hunter
 - P. 129 P226 Legion
 - P. 129 P229 SL
- P. 131 Sig P210
 - P. 132 Sig P210 - 9x19
 - P. 134 Sig P210/5- 9x19
 - P. 136 Sig Sauer P210 - 9x19
 - P. 138 Sig Sauer P210 Super Target - 9x19
- P. 139 1911
 - P. 139 Classic .45
 - P. 139 Classic .40
 - P. 139 Classic 9 mm
 - P. 139 Bull .45
 - P. 139 Bull .40
 - P. 139 Bull 9 mm
 - P. 139 Classic + Wilson / Nowlin .45
 - P. 139 Classic + Wilson / Nowlin .40
 - P. 139 Classic + Wilson / Nowlin .9 mm
 - P. 139 Bull + Wilson / Nowlin .45
 - P. 139 Bull + Wilson / Nowlin .40
 - P. 139 Bull + Wilson / Nowlin 9 mm
 - P. 139 Classic + Para Ordnance .45
 - P. 139 Classic + Para Ordnance .40
 - P. 139 Classic + Para Ordnance 9 mm
 - P. 139 Bull+ Para Ordnance .45
 - P. 139 Bull+ Para Ordnance .40
 - P. 139 Bull+ Para Ordnance 9 mm
- P. 159 Steyr
 - P. 160 Steyr M12
 - P. 161 Steyr GB
- P. 163 Heckler & Koch
 - P. 164 HK P30 - 9x19
 - P. 166 HK P2000 - 9x19

IGB BARRELS FOR GLOCK

- P. 168 HK USP9 - 9x19
- P. 170 HK USP40 - .40 S&W
- P. 172 HK USP45 - .45 acp
- P. 174 HK45 - .45 acp
- P. 176 HK Mark 23 - .45 acp
- P. 178 HK SFP9 - 9x19
- P. 181 FN
- P. 182 FN HP – 9x19
- P. 185 Accessories
 - P. 186 Compensator Shark / Kompensator Shark
 - P. 186 Compensator Shark Compact / Kompensator Shark Compact
 - P. 186 Frequency Converter / Schwingungsdämpfer
 - P. 186 Adaptor Gen 3 to Gen 4 / Adapterring Gen 3 zu Gen 4
 - P. 187 Threadprotector Steel Black* / Gewindeschutz Stahl Schwarz*
 - P. 187 Spring Set for Compensator / Federnset für Kompensator
 - P. 187 Shroud for GX Barrels / Laufmantel für GX Läufe
 - P. 187 Glock Magazine / Glockmagazin

IGB BARRELS IDEAS

Make it YOUR Gun with the IGB Variety
 Machen Sie es zu IHRER Pistole mit den IGB Variationen.

Add Custom Surface Oberflächenoptionen

	Price / Preis
PVD (Gold, Silver, Tan, Bronze, ...)	Base + A05
Sandblast / Sandgestrahlt	Base +A04
Twisted Fluted / Spiralgeflutet	Base +A02
Straight Fluted / Geradegeflutet	Base +A02

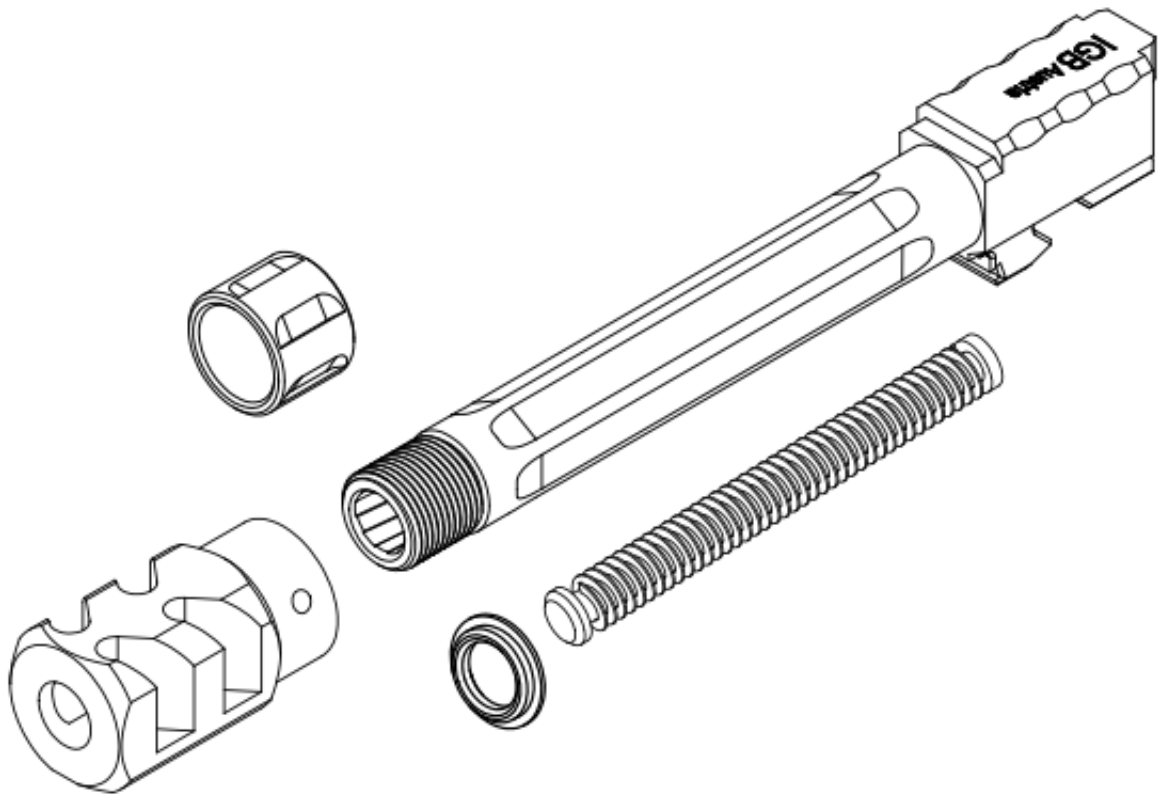
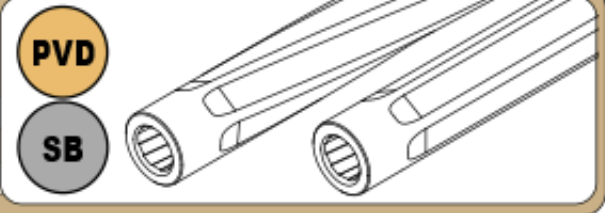

Polygonal vs Hexagonal

Polygonal is very smooth inside and therefore very gastight for high velocity.
 Polygonal ist formbedingt sehr Gasdicht für hohe Geschwindigkeiten.

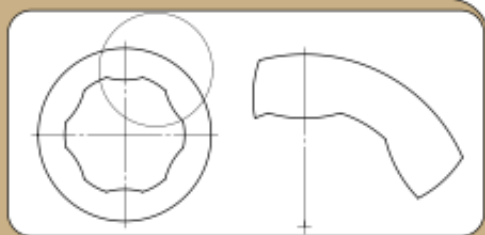
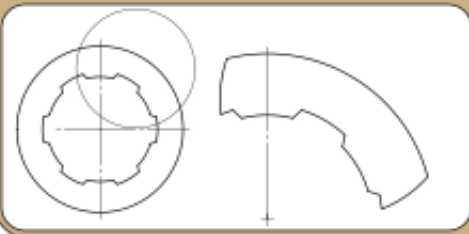

Hexagonal is the more classic approach and also well suited for pure lead.
 Hexagonal ist der klassischere Ansatz und gut geeignet für reine Bleigeschöße.

IGB BARRELS FOR GLOCK

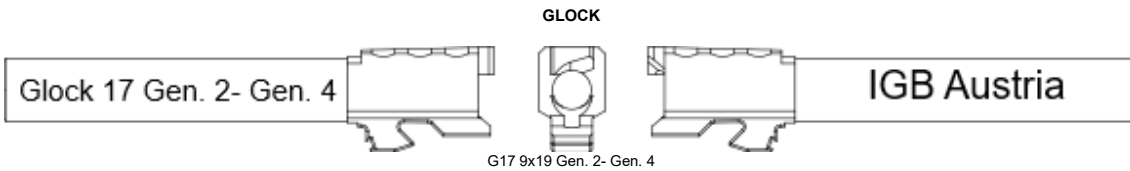

Glock 17 Gen.2 – Gen. 4 Standard Length (114 MM)

Order No. Artikelnr.	From Von	Inner Profile Innenprofil	To Zu	Length Länge	Price Preis
17A-P919-S114	9x19	Polygonal	9x19	114 MM	H
17A-H919-S114	9x19	Hexagonal	9x19	114 MM	H
17A-P921-S114	9x19	Polygonal	9x21	114 MM	H
17A-H919-S114	9x19	Hexagonal	9x21	114 MM	H
17A-H765-S114	9x19	Hexagonal	7,65 Para*	114 MM	H

*9mm Magazine can be used / 9mm Magazin kann verwendet werden

Glock 17 Gen. 2 – Gen. 4 L=153 MM (6")

Order No. Artikelnr.	From Von	Inner Profile Innenprofil	To Zu	Length Länge	Price Preis
17A-P919-153	9x19	Polygonal	9x19	153 MM	I
17A-H919-153	9x19	Hexagonal	9x19	153 MM	I
17A-P921-153	9x19	Polygonal	9x21	153 MM	I
17A-H919-153	9x19	Hexagonal	9x21	153 MM	I
17A-H765-153	9x19	Hexagonal	7,65 Para*	153 MM	I

*9mm Magazine can be used / 9mm Magazin kann verwendet werden

Glock 17 Gen. 2 – Gen. 4 L=191 MM (7.5")

Order No. Artikelnr.	From Von	Inner Profile Innenprofil	To Zu	Length Länge	Price Preis
17A-P919-191	9x19	Polygonal	9x19	191 MM	J
17A-H919-191	9x19	Hexagonal	9x19	191 MM	J
17A-P921-191	9x19	Polygonal	9x21	191 MM	J
17A-H919-191	9x19	Hexagonal	9x21	191 MM	J

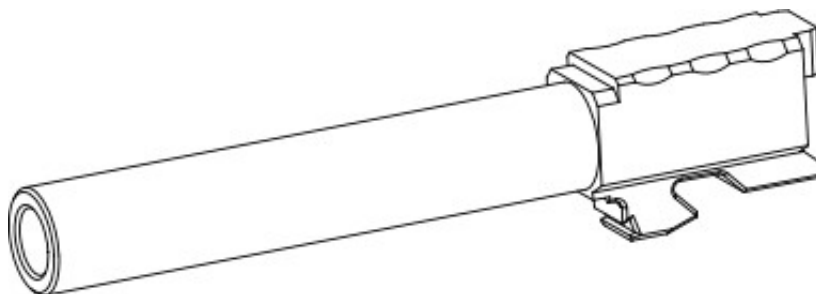

IGB BARRELS FOR GLOCK

Glock 17 Gen. 2- Gen. 4

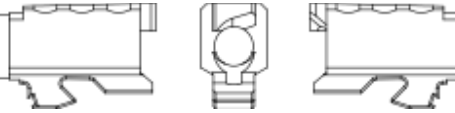

IGB Austria

Glock 17 Gen. 2 – Gen. 4 Threaded / Gewinde L=128 MM (5“)

Caliber Kaliber	Profile Profil	Threading Gewinde	Order No. Artikelnr.	Threading Gewinde	Order No. Artikelnr.	Price Preis
9x19	Hexa	M13x1	17A-P919-128-G02	M14x1	17A-P919-128-G05	H+A01
9x19	Poly	M13x1	17A-H919-128-G02	M14x1	17A-H919-128-G05	H+A01
9x21	Hexa	M13x1	17AP921-128-G02	M14x1	17A-P921-128-G05	H+A01
9x21	Poly	M13x1	17A-H921-128-G02	M14x1	17A-H921-128-G05	H+A01
7,65 Para	Hexa	M13x1	17A-H765-128-G02	M14x1	17A-H765-128-G05	H+A01

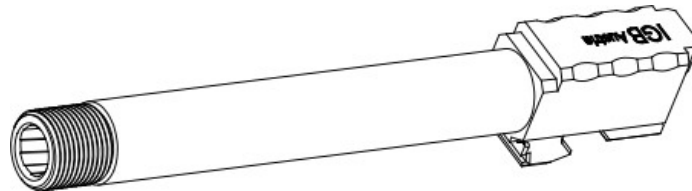

Glock 17 Gen. 2 – Gen. 4 Threaded / Gewinde L=128 MM (5“)

Caliber Kaliber	Profile Profil	Threading Gewinde	Order No. Artikelnr.	Threading Gewinde	Order No. Artikelnr.	Price Preis
9x19	Hexa	1/2x28	17A-P919-128-G01	13,5x1L	17A-P919-128-G04	H+A01
9x19	Poly	1/2x28	17A-H919-128-G01	13,5x1L	17A-H919-128-G04	H+A01
9x21	Hexa	1/2x28	17AP921-128-G01	13,5x1L	17A-P921-128-G04	H+A01
9x21	Poly	1/2x28	17A-H921-128-G01	13,5x1L	17A-H921-128-G04	H+A01
7,65 Para	Hexa	1/2x28	17A-H765-128-G01	13,5x1L	17A-H765-128-G04	H+A01

More threadings on request / Mehr Gewinde auf Anfrage

Accessories / Zubehör

	Price / Preis
Model Shark	A09
Model Shark Compact	A09
Steel Thread Protector	A08

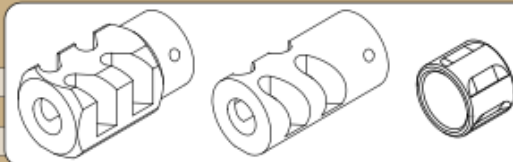

Add Custom Surface Oberflächenoptionen

	Price / Preis
PVD (Gold, Silver, Tan, Bronze, ...)	Base + A05
Sandblast / Sandgestrahlt	Base +A04
Twisted Fluted / Spiralgefütet	Base +A02
Straight Fluted / Geradegefütet	Base +A02

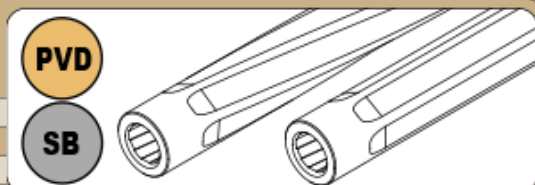

IGB BARRELS FOR GLOCK

Glock 17 Gen. 2- Gen. 4



IGB Austria

Glock 17 Gen. 2 – Gen. 4 L=255 MM (10“) with 1/2x28 UNEF

Order No. Artikelnr.	From Von	Inner Profile Innenprofil	To Zu	Length Länge	Price Preis
17A-P919-255	9x19	Hexagonal	9x19	255 MM	K
17A-H919-255	9x19	Hexagonal	9x19	255 MM	K
17A-P921-255	9x19	Polygonal	9x21	255 MM	K
17A-H919-255	9x19	Hexagonal	9x21	255 MM	K

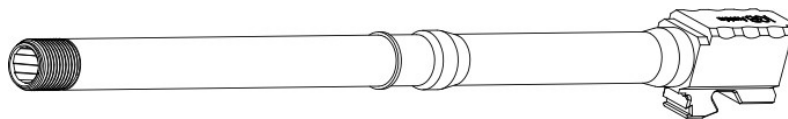

Accessories 10" Zubehör 255 MM

	Price / Preis
Muzzledevice / Schwingungsdämpfer	A09
Ported Shroud 10" / Laufmantel Geportet 255 MM	A12
Steel Thread Protector / Gewindeschutz	A08

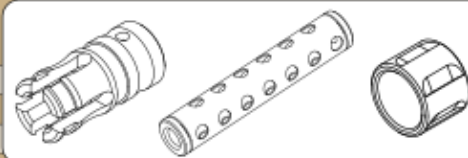

Glock 17 Gen. 2 – Gen. 4 L=410 MM (16“) with 1/2x28 UNEF

Order No. Artikelnr.	From Von	Inner Profile Innenprofil	To Zu	Length Länge	Price Preis
17A-P919-410	9x19	Hexagonal	9x19	410 MM	L
17A-H919-410	9x19	Hexagonal	9x19	410 MM	L
17A-P921-410	9x19	Polygonal	9x21	410 MM	L
17A-H919-410	9x19	Hexagonal	9x21	410 MM	L

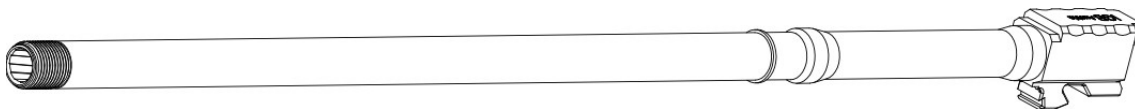

Accessories 16" Zubehör 410 MM

	Price / Preis
Muzzledevice / Schwingungsdämpfer	A09
Ported Shroud 16" / Laufmantel Geportet 410 MM	A13
Steel Thread Protector / Gewindeschutz	A08

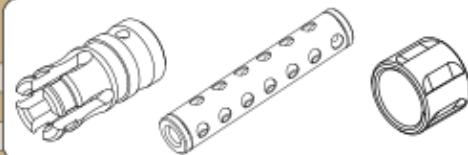

IGB BARRELS FOR GLOCK

Glock 17 Gen. 5

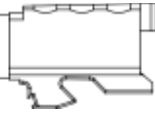

G17 9x19 Gen. 5

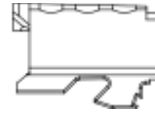

IGB Austria

Glock 17 Gen. 5 Standard Length (114 MM)

Order No. Artikelnr.	From Von	Inner Profile Innenprofil	To Zu	Length Länge	Price Preis
17B-P919-S114	9x19	Polygonal	9x19	114 MM	H
17B-H919-S114	9x19	Hexagonal	9x19	114 MM	H
17B-P921-S114	9x19	Polygonal	9x21	114 MM	H
17B-H919-S114	9x19	Hexagonal	9x21	114 MM	H
17B-H765-S114	9x19	Hexagonal	7,65 Para*	114 MM	H

*9mm Magazine can be used / 9mm Magazin kann verwendet werden

Glock 17 Gen. 5 L=153 MM (6")

Order No. Artikelnr.	From Von	Inner Profile Innenprofil	To Zu	Length Länge	Price Preis
17B-P919-153	9x19	Polygonal	9x19	153 MM	I
17B-H919-153	9x19	Hexagonal	9x19	153 MM	I
17B-P921-153	9x19	Polygonal	9x21	153 MM	I
17B-H921-153	9x19	Hexagonal	9x21	153 MM	I
17B-H919-153	9x19	Hexagonal	7,65 Para*	153 MM	I

*9mm Magazine can be used / 9mm Magazin kann verwendet werden

Glock 17 Gen. 5 – Gen. 4 L=191 MM (7.5")

Order No. Artikelnr.	From Von	Inner Profile Innenprofil	To Zu	Length Länge	Price Preis
17B-P919-191	9x19	Polygonal	9x19	191 MM	J
17B-H919-191	9x19	Hexagonal	9x19	191 MM	J
17B-P921-191	9x19	Polygonal	9x21	191 MM	J
17B-H919-191	9x19	Hexagonal	9x21	191 MM	J

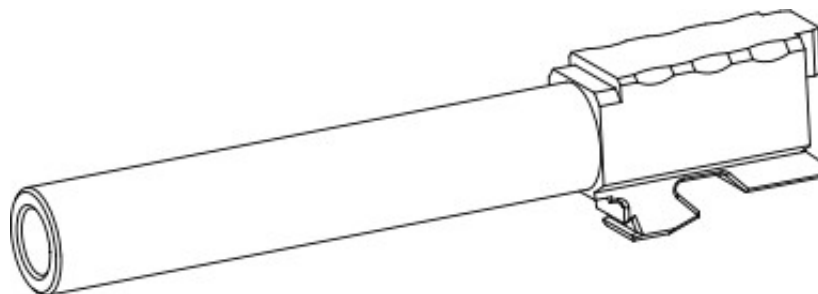

IGB BARRELS FOR GLOCK

Glock 17 Gen. 5

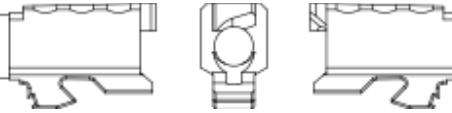

IGB Austria

Glock 17 Gen. 5 Threaded / Gewinde L=128 MM (5")

Caliber Kaliber	Profile Profil	Threading Gewinde	Order No. Artikelnr.	Threading Gewinde	Order No. Artikelnr.	Price Preis
9x19	Hexa	M13x1	17B-P919-128-G02	M14x1	17B-P919-128-G05	H+A01
9x19	Poly	M13x1	17B-H919-128-G02	M14x1	17B-H919-128-G05	H+A01
9x21	Hexa	M13x1	17B-P921-128-G02	M14x1	17B-P921-128-G05	H+A01
9x21	Poly	M13x1	17B-H921-128-G02	M14x1	17B-H921-128-G05	H+A01
7,65 Para	Hexa	M13x1	17B-H765-128-G02	M14x1	17B-H765-128-G05	H+A01

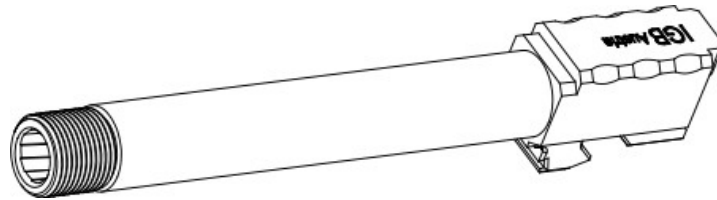

Glock 17 Gen. 5 Threaded / Gewinde L=128 MM (5")

Caliber Kaliber	Profile Profil	Threading Gewinde	Order No. Artikelnr.	Threading Gewinde	Order No. Artikelnr.	Price Preis
9x19	Hexa	1/2x28	17B-P919-128-G01	13,5x1L	17B-P919-128-G04	H+A01
9x19	Poly	1/2x28	17B-H919-128-G01	13,5x1L	17B-H919-128-G04	H+A01
9x21	Hexa	1/2x28	17B-P921-128-G01	13,5x1L	17B-P921-128-G04	H+A01
9x21	Poly	1/2x28	17B-H921-128-G01	13,5x1L	17B-H921-128-G04	H+A01
7,65 Para	Hexa	1/2x28	17B-H765-128-G01	13,5x1L	17B-H765-128-G04	H+A01

More threadings on request / Mehr Gewinde auf Anfrage

Accessories / Zubehör

	Price / Preis
Model Shark	A09
Model Shark Compact	A09
Steel Thread Protector	A08

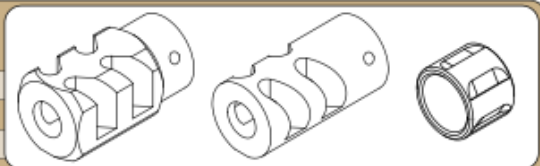

Add Custom Surface
Oberflächenoptionen

	Price / Preis
PVD (Gold, Silver, Tan, Bronze, ...)	Base + A05
Sandblast / Sandgestrahlt	Base +A04
Twisted Fluted / Spiralgefütet	Base +A02
Straight Fluted / Geradegefütet	Base +A02

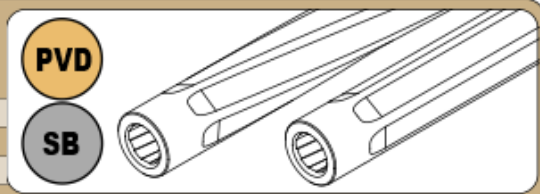

IGB BARRELS FOR GLOCK

Glock 17 Gen. 5

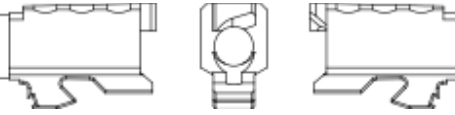

IGB Austria

Glock 17 Gen. 5 L=255 MM (10") with 1/2x28 UNEF

Order No. Artikelnr.	From Von	Inner Profile Innenprofil	To Zu	Length Länge	Price Preis
17B-P919-255	9x19	Hexagonal	9x19	255 MM	K
17B-H919-255	9x19	Hexagonal	9x19	255 MM	K
17B-P921-255	9x19	Polygonal	9x21	255 MM	K
17B-H919-255	9x19	Hexagonal	9x21	255 MM	K

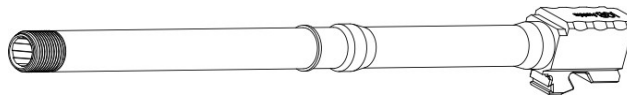

Accessories 10" Zubehör 255 MM

	Price / Preis
Muzzledevice / Schwingungsdämpfer	A09
Ported Shroud 10" / Laufmantel Geportet 255 MM	A12
Steel Thread Protector / Gewindeschutz	A08

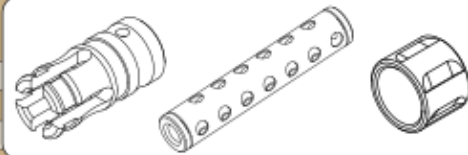

Glock 17 Gen. 5 L=410 MM (16") with 1/2x28 UNEF

Order No. Artikelnr.	From Von	Inner Profile Innenprofil	To Zu	Length Länge	Price Preis
17B-P919-410	9x19	Hexagonal	9x19	410 MM	L
17B-H919-410	9x19	Hexagonal	9x19	410 MM	L
17B-P921-410	9x19	Polygonal	9x21	410 MM	L
17B-H919-410	9x19	Hexagonal	9x21	410 MM	L

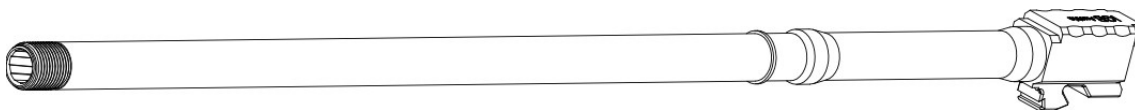

Accessories 16" Zubehör 410 MM

	Price / Preis
Muzzledevice / Schwingungsdämpfer	A09
Ported Shroud 16" / Laufmantel Geportet 410 MM	A13
Steel Thread Protector / Gewindeschutz	A08

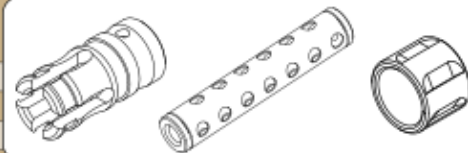

IGB .22lr SYSTEM FOR GLOCK

.22lr Conversion Set

Containing barrel, Slide with MOS Cut, Recoilspring, Magazine for platform Glock 17 or Glock 19

.22lr Wechselsystem

Bestehend aus Lauf, Verschluss mit MOS-Cut, Feder und Magazin für Plattform Glock 17 or Glock 19

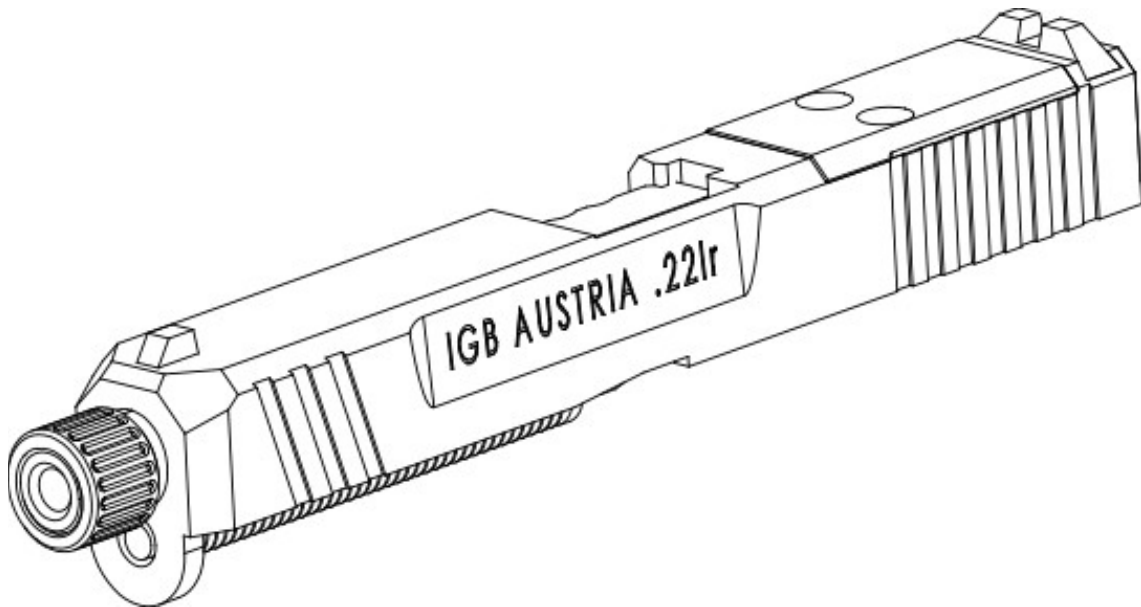

22lr Systeme

Order No. Artikelnr.	For Für	Threading Gewinde	Price Preis
WS-17A-2	Glock 17 / 34 Gen. 3-4	1/2x28 UNEF	B
WS-17B-2	Glock 17 / 34 Gen. 5	1/2x28 UNEF	B
WS-19A-2	Glock 19 Gen. 3-5 / Glock 45	1/2x28 UNEF	B

Spare Parts / Ersatzteile

Order No. Artikelnr.	Part Teil	Price Preis
WS-M10	Magazine 10rd	B01
WS--XG	Gas Piston / Gasstempel	B02
WS-V17A	Recoilspring / Vorholfeder G17 Gen3-4	B03
WS-V17B	Recoilspring / Vorholfeder G17 Gen5	B03
WS-V19A	Recoilspring / Vorholfeder G19 Gen3-5	B03
WS-XS	Striker unit / Schlagbolzeneinheit	B04
WS-XA	Extractor unit / Ausziehereinheit	B05

IGB BARRELS FOR GLOCK

Glock 19 Gen. 2 - Gen.5

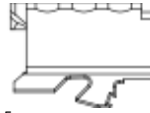
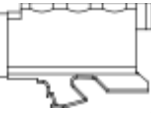

IGB Austria

G19 9x19 Gen. 2- Gen. 5

Glock 19 Gen. 2 – Gen. 5 Standard Length (102 MM)

Order No. Artikelnr.	From Von	Inner Profile Innenprofil	To Zu	Length Länge	Price Preis
19A-P919-S102	9x19	Polygonal	9x19	102 MM	H
19A-H919-S102	9x19	Hexagonal	9x19	102 MM	H
19A-P380-S102	9x19	Polygonal	.380*	102 MM	H
19A-H380-S102	9x19	Hexagonal	.380*	102 MM	H
19A-H765-S102	9x19	Hexagonal	7,65 Para*	102 MM	H
19A-H9M-S102	9x19	Hexagonal	9 Makarov*	102 MM	H

*9mm Magazine can be used / 9mm Magazin kann verwendet werden

Glock 19 Gen. 2 – Gen. 5 L=153 MM (6“)

Order No. Artikelnr.	From Von	Inner Profile Innenprofil	To Zu	Length Länge	Price Preis
19A-P919-153	9x19	Polygonal	9x19	153 MM	I
19A-H919-153	9x19	Hexagonal	9x19	153 MM	I
19A-P380-153	9x19	Polygonal	.380*	153 MM	I
19A-H380-153	9x19	Hexagonal	.380*	153 MM	I
19A-H765-153	9x19	Hexagonal	7,65 Para*	153 MM	I
19A-H9M-153	9x19	Hexagonal	9 Makarov*	153 MM	I

*9mm Magazine can be used / 9mm Magazin kann verwendet werden

Glock 19 Gen. 2 – Gen. 5 L=191 MM (7.5“)

Order No. Artikelnr.	From Von	Inner Profile Innenprofil	To Zu	Length Länge	Price Preis
19A-P919-191	9x19	Polygonal	9x19	191 MM	J
19A-H919-191	9x19	Hexagonal	9x19	191 MM	J
19A-P919-191	9x19	Polygonal	9x21	191 MM	J
19A-H919-191	9x19	Hexagonal	9x21	191 MM	J



IGB BARRELS FOR GLOCK



Glock 19 Gen. 2 – Gen. 5 Threaded / Gewinde L=116 MM (4.6“)

Caliber Kaliber	Profile Profil	Threading Gewinde	Order No. Artikelnr.	Threading Gewinde	Order No. Artikelnr.	Price Preis
9x19	Hexa	M13x1	19A-P919-116-G02	M14x1	19A-P919-116-G05	H+A01
9x19	Poly	M13x1	19A-H919-116-G02	M14x1	19A-H919-116-G05	H+A01
.380	Hexa	M13x1	19A-H380-116-G02	M14x1	19A-H380-116-G05	H+A01
.380	Poly	M13x1	19A-P380-116-G02	M14x1	19A-P380-116-G05	H+A01
7,65 Para	Hexa	M13x1	19A-H765-116-G02	M14x1	19A-H765-116-G05	H+A01
9 Mak	Hexa	M13x1	19A-H9M-116-G02	M14x1	19A-H9M-116-G05	H+A01

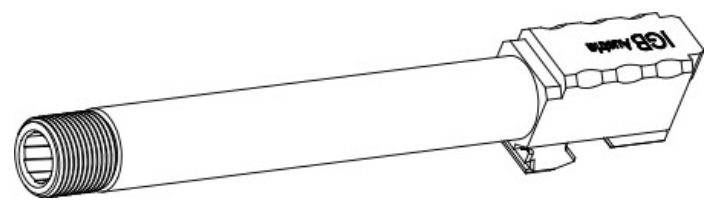

Glock 19 Gen. 2 – Gen. 5 Threaded / Gewinde L=116 MM (4.6“)

Caliber Kaliber	Profile Profil	Threading Gewinde	Order No. Artikelnr.	Threading Gewinde	Order No. Artikelnr.	Price Preis
9x19	Hexa	1/2x28	19A-P919-116-G01	13,5x1L	19A-P919-116-G04	H+A01
9x19	Poly	1/2x28	19A-H919-116-G01	13,5x1L	19A-H919-116-G04	H+A01
.380	Hexa	1/2x28	19A-H380-116-G01	13,5x1L	19A-H380-116-G04	H+A01
.380	Poly	1/2x28	19A-P380-116-G01	13,5x1L	19A-P380-116-G04	H+A01
7,65 Para	Hexa	1/2x28	19A-H765-116-G01	13,5x1L	19A-H765-116-G04	H+A01
9 Mak	Hexa	1/2x28	19A-H9M-116-G01	13,5x1L	19A-H9M-116-G04	H+A01

More threadings on request / Mehr Gewinde auf Anfrage

Accessories / Zubehör		Price / Preis		
Model Shark		A09		
Model Shark Compact		A09		
Steel Thread Protector		A08		

Add Custom Surface Oberflächenoptionen		Price / Preis		
PVD (Gold, Silver, Tan, Bronze, ...)		Base + A05		
Sandblast / Sandgestrahlt		Base +A04		
Twisted Fluted / Spiralgeflutet		Base +A02		
Straight Fluted / Geradegeflutet		Base +A02		

IGB BARRELS FOR GLOCK

Glock 19 Gen. 2 - Gen.5

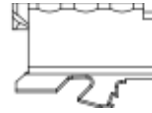
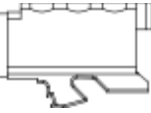

IGB Austria

Glock 19 Gen. 2 – Gen. 5 L=255 MM (10“) with 1/2x28 UNEF

Order No. Artikelnr.	From Von	Inner Profile Innenprofil	To Zu	Length Länge	Price Preis
19A-P919-255	9x19	Hexagonal	9x19	255 MM	K
19A-H919-255	9x19	Hexagonal	9x19	255 MM	K
19A-P919-255	9x19	Polygonal	9x21	255 MM	K
19A-H919-255	9x19	Hexagonal	9x21	255 MM	K

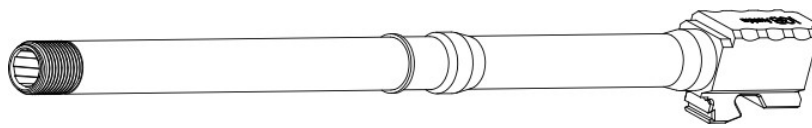

Accessories 10" Zubehör 255 MM

	Price / Preis
Muzzledevice / Schwingungsdämpfer	A09
Ported Shroud 10" / Laufmantel Geportet 255 MM	A12
Steel Thread Protector / Gewindeschutz	A08

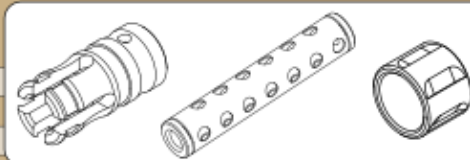

Glock 19 Gen. 2 – Gen. 5 L=410 MM (16“) with 1/2x28 UNEF

Order No. Artikelnr.	From Von	Inner Profile Innenprofil	To Zu	Length Länge	Price Preis
19A-P919-410	9x19	Hexagonal	9x19	410 MM	L
19A-H919-410	9x19	Hexagonal	9x19	410 MM	L
19A-P919-410	9x19	Polygonal	9x21	410 MM	L
19A-H919-410	9x19	Hexagonal	9x21	410 MM	L

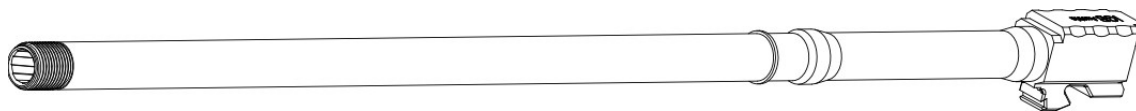

Accessories 16" Zubehör 410 MM

	Price / Preis
Muzzledevice / Schwingungsdämpfer	A09
Ported Shroud 16" / Laufmantel Geportet 410 MM	A13
Steel Thread Protector / Gewindeschutz	A08

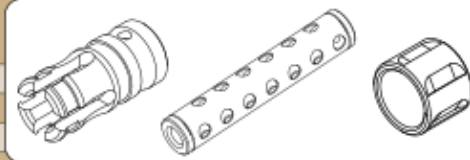

IGB .22lr SYSTEM FOR GLOCK

.22lr Conversion Set
 Containing barrel, Slide with MOS Cut, Recoilspring, Magazine for platform Glock 17 or Glock 19

.22lr Wechselsystem
 Bestehend aus Lauf, Verschluss mit MOS-Cut, Feder und Magazin für Plattform Glock 17 or Glock 19

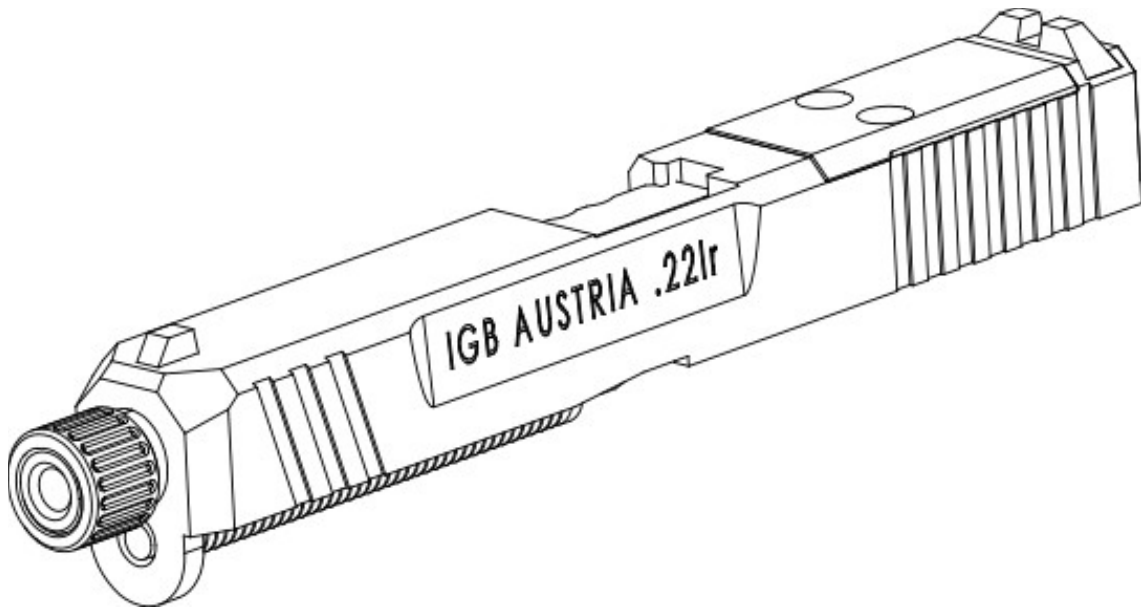

22lr Systeme

Order No. Artikelnr.	For Für	Threading Gewinde	Price Preis
WS-17A-2	Glock 17 / 34 Gen. 3-4	1/2x28 UNEF	B
WS-17B-2	Glock 17 / 34 Gen. 5	1/2x28 UNEF	B
WS-19A-2	Glock 19 Gen. 3-5 / Glock 45	1/2x28 UNEF	B

Spare Parts / Ersatzteile

Order No. Artikelnr.	Part Teil	Price Preis
WS-M10	Magazine 10rd	B01
WS--XG	Gas Piston / Gasstempel	B02
WS-V17A	Recoilspring / Vorhofeder G17 Gen3-4	B03
WS-V17B	Recoilspring / Vorhofeder G17 Gen5	B03
WS-V19A	Recoilspring / Vorhofeder G19 Gen3-5	B03
WS-XS	Striker unit / Schlagbolzeneinheit	B04
WS-XA	Extractor unit / Ausziehereinheit	B05

IGB BARRELS FOR GLOCK

Glock 20



G20 10 Auto

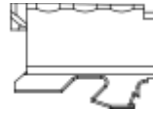

IGB Austria

Glock 20 Standard Length (118 MM)

Order No. Artikelnr.	From Von	Inner Profile Innenprofil	To Zu	Length Länge	Price Preis
20A-H010-S118	10 Auto	Hexagonal	10Auto	118 MM	H
20A-H040-S118	10 Auto	Hexagonal	40 S&W	118 MM	H
20A-P357-S118	10 Auto	Polygonal	357 Sig	118 MM	H
20A-H357-S118	10 Auto	Hexagonal	357 Sig	118 MM	H
20A-P925-S118	10 Auto	Polygonal	9x25 Dillon	118 MM	H
20A-H925-S118	10 Auto	Hexagonal	9x25 Dillon	118 MM	H

Glock 20 L=153 MM (6")

Order No. Artikelnr.	From Von	Inner Profile Innenprofil	To Zu	Length Länge	Price Preis
20A-H010-153	10 Auto	Hexagonal	10Auto	153 MM	I
20A-H040-153	10 Auto	Hexagonal	40 S&W	153 MM	I
20A-P357-153	10 Auto	Polygonal	357 Sig	153 MM	I
20A-H357-153	10 Auto	Hexagonal	357 Sig	153 MM	I
20A-P925-153	10 Auto	Polygonal	9x25 Dillon	153 MM	I
20A-H925-153	10 Auto	Hexagonal	9x25 Dillon	153 MM	I

Glock 20 L=191 MM (7.5")

Order No. Artikelnr.	From Von	Inner Profile Innenprofil	To Zu	Length Länge	Price Preis
20A-H010-191	10 Auto	Hexagonal	10Auto	191 MM	J
20A-H040-191	10 Auto	Hexagonal	40 S&W	191 MM	J
20A-P357-191	10 Auto	Polygonal	357 Sig	191 MM	J
20A-H357-191	10 Auto	Hexagonal	357 Sig	191 MM	J
20A-P925-191	10 Auto	Polygonal	9x25 Dillon	191 MM	J
20A-H925-191	10 Auto	Hexagonal	9x25 Dillon	191 MM	J

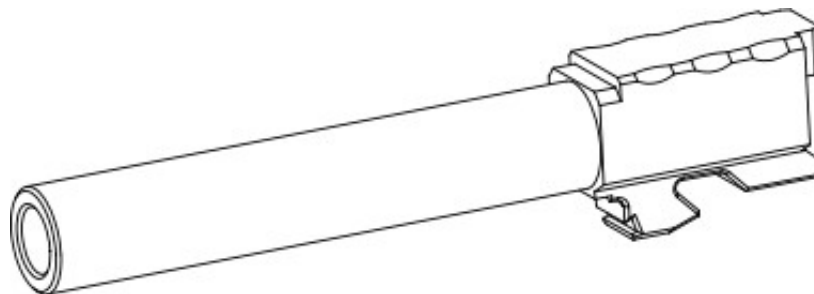

IGB BARRELS FOR GLOCK



Glock 20 Threaded / Gewinde L=132 MM (5.2“)

Caliber Kaliber	Profile Profil	Threading Gewinde	Order No. Artikelnr.	Threading Gewinde	Order No. Artikelnr.	Price Preis
10Auto	Hexa	M15x1	20A-H010-132-G07	M16x1	20A-H010-132-G09	H+A01
40 S&W	Hexa	M15x1	20A-H040-132-G07	M16x1	20A-H040-132-G09	H+A01
357 Sig	Poly	M15x1	20A-P357-132-G07	M16x1	20A-P357-132-G09	H+A01
357 Sig	Hexa	M15x1	20A-H357-132-G07	M16x1	20A-H357-132-G09	H+A01
9x25 DII	Poly	M15x1	20A-P925-132-G07	M16x1	20A-P925-132-G09	H+A01
9x25 DII	Hexa	M15x1	20A-H925-132-G07	M16x1	20A-H925-132-G09	H+A01

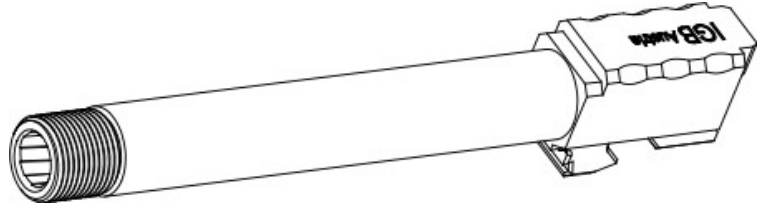

Glock 20 Threaded / Gewinde L=132 MM (5.2“)

Caliber Kaliber	Profile Profil	Threading Gewinde	Order No. Artikelnr.	Threading Gewinde	Order No. Artikelnr.	Price Preis
10Auto	Hexa	M14x1	20A-H010-132-G05	M14x1L	20A-H010-132-G06	H+A01
40 S&W	Hexa	M14x1	20A-H040-132-G05	M14x1L	20A-H040-132-G06	H+A01
357 Sig	Poly	1/2x28	20A-P357-132-G01	13,5x1L	20A-P357-132-G04	H+A01
357 Sig	Hexa	1/2x28	20A-H357-132-G01	13,5x1L	20A-H357-132-G04	H+A01
9x25 DII	Poly	1/2x28	20A-P925-132-G01	13,5x1L	20A-P925-132-G04	H+A01
9x25 DII	Hexa	1/2x28	20A-H925-132-G01	13,5x1L	20A-H925-132-G04	H+A01

More threadings on request / Mehr Gewinde auf Anfrage

Accessories / Zubehör		Price / Preis
Model Shark		A09
Model Shark Compact		A09
Steel Thread Protector		A08

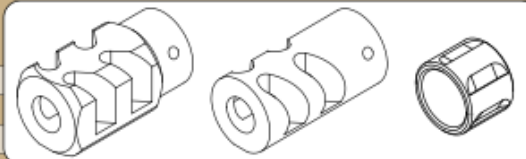

Add Custom Surface Oberflächenoptionen		Price / Preis
PVD (Gold, Silver, Tan, Bronze, ...)		Base + A05
Sandblast / Sandgestrahlt		Base + A04
Twisted Fluted / Spiralgefütet		Base + A02
Straight Fluted / Geradegefütet		Base + A02

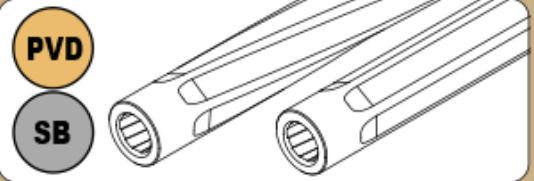

IGB BARRELS FOR GLOCK

Glock 20

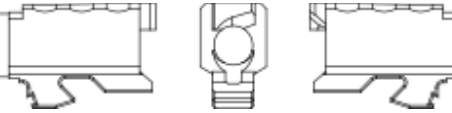

IGB Austria

Glock 20 L=255 MM (10") with M15x1

Order No. Artikelnr.	From Von	Inner Profile Innenprofil	To Zu	Length Länge	Price Preis
20A-H010-255	10 Auto	Hexagonal	10Auto	255 MM	K
20A-H040-255	10 Auto	Hexagonal	40 S&W	255 MM	K
20A-P357-255	10 Auto	Polygonal	357 Sig	255 MM	K
20A-H357-255	10 Auto	Hexagonal	357 Sig	255 MM	K
20A-P925-255	10 Auto	Polygonal	9x25 Dillon	255 MM	K
20A-H925-255	10 Auto	Hexagonal	9x25 Dillon	255 MM	K

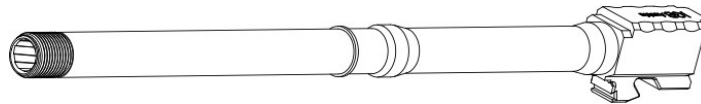

Accessories 10" Zubehör 255 MM

	Price / Preis
Muzzledevice / Schwingungsdämpfer	A09
Ported Shroud 10" / Laufmantel Geportet 255 MM	A12
Steel Thread Protector / Gewindeschutz	A08

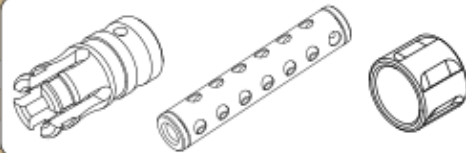

Glock 20 L=410 MM (16") with M15x1

Order No. Artikelnr.	From Von	Inner Profile Innenprofil	To Zu	Length Länge	Price Preis
20A-H010-410	10 Auto	Hexagonal	10Auto	410 MM	L
20A-H040-410	10 Auto	Hexagonal	40 S&W	410 MM	L
20A-P357-410	10 Auto	Polygonal	357 Sig	410 MM	L
20A-H357-410	10 Auto	Hexagonal	357 Sig	410 MM	L
20A-P925-410	10 Auto	Polygonal	9x25 Dillon	410 MM	L
20A-H925-410	10 Auto	Hexagonal	9x25 Dillon	410 MM	L

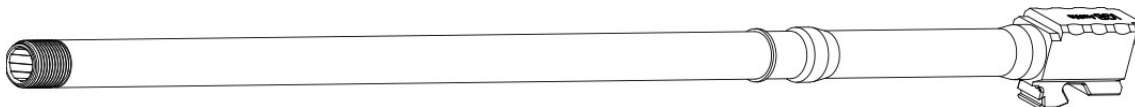

Accessories 16" Zubehör 410 MM

	Price / Preis
Muzzledevice / Schwingungsdämpfer	A09
Ported Shroud 16" / Laufmantel Geportet 410 MM	A13
Steel Thread Protector / Gewindeschutz	A08

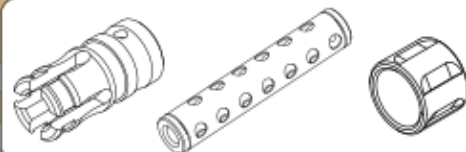

IGB BARRELS FOR GLOCK

Glock 21

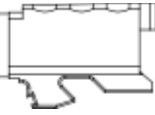

G21 .45 ACP

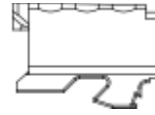

IGB Austria

Glock 21 Standard Length (118 MM)

Order No. Artikelnr.	From Von	Inner Profile Innenprofil	To Zu	Length Länge	Price Preis
21A-H045-S118	45 acp	Hexagonal	45 acp	118 MM	H
21A-H400-S118	45 acp	Hexagonal	400 CorBon	118 MM	H
21A-H010-S118	45 acp	Hexagonal	10Auto	118 MM	H
21A-H040-S118	45 acp	Hexagonal	40 S&W	118 MM	H
21A-P357-S118	45 acp	Polygonal	357 Sig	118 MM	H
21A-H357-S118	45 acp	Hexagonal	357 Sig	118 MM	H
21A-P925-S118	45 acp	Polygonal	9x25 Dillon	118 MM	H
21A-H925-S118	45 acp	Hexagonal	9x25 Dillon	118 MM	H

Glock 21 L=153 MM (6")

Order No. Artikelnr.	From Von	Inner Profile Innenprofil	To Zu	Length Länge	Price Preis
21A-H045-153	45 acp	Hexagonal	45 acp	153 MM	I
21A-H400-153	45 acp	Hexagonal	400 CorBon	153 MM	I
21A-H010-153	45 acp	Hexagonal	10Auto	153 MM	I
21A-H040-153	45 acp	Hexagonal	40 S&W	153 MM	I
21A-P357-153	45 acp	Polygonal	357 Sig	153 MM	I
21A-H357-153	45 acp	Hexagonal	357 Sig	153 MM	I
21A-P925-153	45 acp	Polygonal	9x25 Dillon	153 MM	I
21A-H925-153	45 acp	Hexagonal	9x25 Dillon	153 MM	I

Glock 21 L=191 MM (7.5")

Order No. Artikelnr.	From Von	Inner Profile Innenprofil	To Zu	Length Länge	Price Preis
21A-H045-191	45 acp	Hexagonal	45 acp	191 MM	J
21A-H400-191	45 acp	Hexagonal	400 CorBon	191 MM	J
21A-H010-191	45 acp	Hexagonal	10Auto	191 MM	J
21A-H040-191	45 acp	Hexagonal	40 S&W	191 MM	J
21A-P357-191	45 acp	Polygonal	357 Sig	191 MM	J
21A-H357-191	45 acp	Hexagonal	357 Sig	191 MM	J
21A-P925-191	45 acp	Polygonal	9x25 Dillon	191 MM	J
21A-H925-191	45 acp	Hexagonal	9x25 Dillon	191 MM	J

IGB BARRELS FOR GLOCK



Caliberchange Kaliberwechsel

**Magazine directly from us!
Magazin gleich bei uns mitbestellen!**

Changing from bigger to smaller cartridge bottom will require you to get a smaller Magazine!
Example; **.45 to .357 Sig = Magazine needed / .45 to 400 CorBon = No Magazine needed**



Wechsel von bestimmten Patronenbodendurchmessern benötigt ein Magazin!
Beispiel; **.45 zu .357 Sig = Magazin benötigt / .45 zu 400 CorBon = Kein Magazin benötigt**

Glock 21 Threaded / Gewinde L=132 MM (5.2")

Caliber Kaliber	Profile Profil	Threading Gewinde	Order No. Artikelnr.	Threading Gewinde	Order No. Artikelnr.	Price Preis
45 acp	Hexa	M15x1	21A-H045-132-G07	M16x1	21A-H045-132-G09	H+A01
400 CrBn	Hexa	M15x1	21A-H400-132-G07	M16x1	21A-H400-132-G09	H+A01
10 Auto	Hexa	M15x1	21A-H010-132-G07	M16x1	21A-H010-132-G09	H+A01
40 S&W	Hexa	M15x1	21A-H040-132-G07	M16x1	21A-H040-132-G09	H+A01
357 Sig	Poly	M15x1	21A-P357-132-G07	M16x1	21A-P357-132-G09	H+A01
357 Sig	Hexa	M15x1	21A-H357-132-G07	M16x1	21A-H357-132-G09	H+A01
9x25 Dll	Poly	M15x1	21A-P925-132-G07	M16x1	21A-P925-132-G09	H+A01
9x25 Dll	Hexa	M15x1	21A-H925-132-G07	M16x1	21A-H925-132-G09	H+A01
Caliber Kaliber	Profile Profil	Threading Gewinde	Order No. Artikelnr.	Threading Gewinde	Order No. Artikelnr.	Price Preis
45 acp	Hexa	M14x1	21A-H045-132-G05	M14x1L	21A-H045-132-G06	H+A01
400 CrBn	Hexa	M14x1	21A-H400-132-G05	M14x1L	21A-H400-132-G06	H+A01
10 Auto	Hexa	M14x1	21A-H010-132-G05	M14x1L	21A-H010-132-G06	H+A01
40 S&W	Hexa	M14x1	21A-H040-132-G05	M14x1L	21A-H040-132-G06	H+A01
357 Sig	Poly	1/2x28	21A-P357-132-G01	13,5x1L	21A-P357-132-G04	H+A01
357 Sig	Hexa	1/2x28	21A-H357-132-G01	13,5x1L	21A-H357-132-G04	H+A01
9x25 Dll	Poly	1/2x28	21A-P925-132-G01	13,5x1L	21A-P925-132-G04	H+A01
9x25 Dll	Hexa	1/2x28	21A-H925-132-G01	13,5x1L	21A-H925-132-G04	H+A01

More threadings on request / Mehr Gewinde auf Anfrage

Add Custom Surface Oberflächenoptionen	Price / Preis
PVD (Gold, Silver, Tan, Bronze, ...)	Base + A05
Sandblast / Sandgestrahlt	Base +A04
Twisted Fluted / Spiralgefütet	Base +A02
Straight Fluted / Geradegefütet	Base +A02

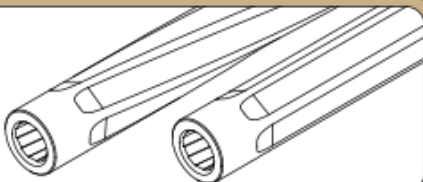

IGB BARRELS FOR GLOCK

Glock 21



IGB Austria

Glock 21 L=255 MM (10") with M15x1

Order No. Artikelnr.	From Von	Inner Profile Innenprofil	To Zu	Length Länge	Price Preis
21A-H045-255	45 acp	Hexagonal	45 acp	255 MM	K
21A-H400-255	45 acp	Hexagonal	400 CorBon	255 MM	K
21A-H010-255	45 acp	Hexagonal	10Auto	255 MM	K
21A-H040-255	45 acp	Hexagonal	40 S&W	255 MM	K
21A-P357-255	45 acp	Polygonal	357 Sig	255 MM	K
21A-H357-255	45 acp	Hexagonal	357 Sig	255 MM	K
21A-P925-255	45 acp	Polygonal	9x25 Dillon	255 MM	K
21A-H925-255	45 acp	Hexagonal	9x25 Dillon	255 MM	K

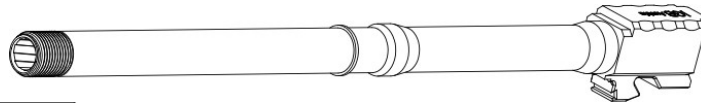
Accessories 10"
Zubehör 255 MM

	Price / Preis
Muzzledevice / Schwingungsdämpfer	A09
Ported Shroud 10" / Laufmantel Geportet 255 MM	A12
Steel Thread Protector / Gewindeschutz	A08

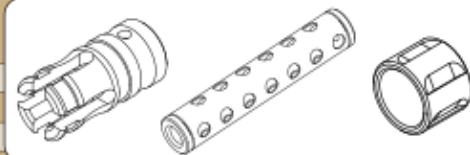

Glock 21 L=410 MM (16") with M15x1

Order No. Artikelnr.	From Von	Inner Profile Innenprofil	To Zu	Length Länge	Price Preis
21A-H045-410	45 acp	Hexagonal	45 acp	410 MM	L
21A-H400-410	45 acp	Hexagonal	400 CorBon	410 MM	L
21A-H010-410	45 acp	Hexagonal	10Auto	410 MM	L
21A-H040-410	45 acp	Hexagonal	40 S&W	410 MM	L
21A-P357-410	45 acp	Polygonal	357 Sig	410 MM	L
21A-H357-410	45 acp	Hexagonal	357 Sig	410 MM	L
21A-P925-410	45 acp	Polygonal	9x25 Dillon	410 MM	L
21A-H925-410	45 acp	Hexagonal	9x25 Dillon	410 MM	L

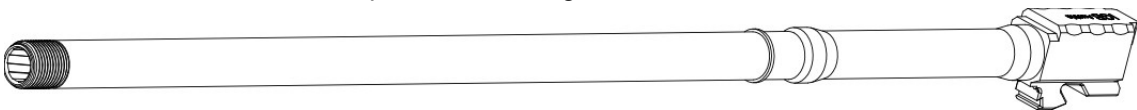
Accessories 16"
Zubehör 410 MM

	Price / Preis
Muzzledevice / Schwingungsdämpfer	A09
Ported Shroud 16" / Laufmantel Geportet 410 MM	A13
Steel Thread Protector / Gewindeschutz	A08

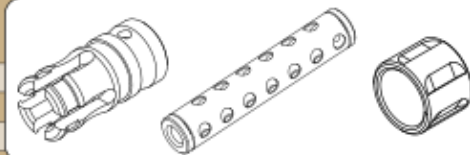

IGB BARRELS IDEAS

Make it YOUR Gun with the IGB Variety
 Machen Sie es zu IHRER Pistole mit den IGB Variationen.

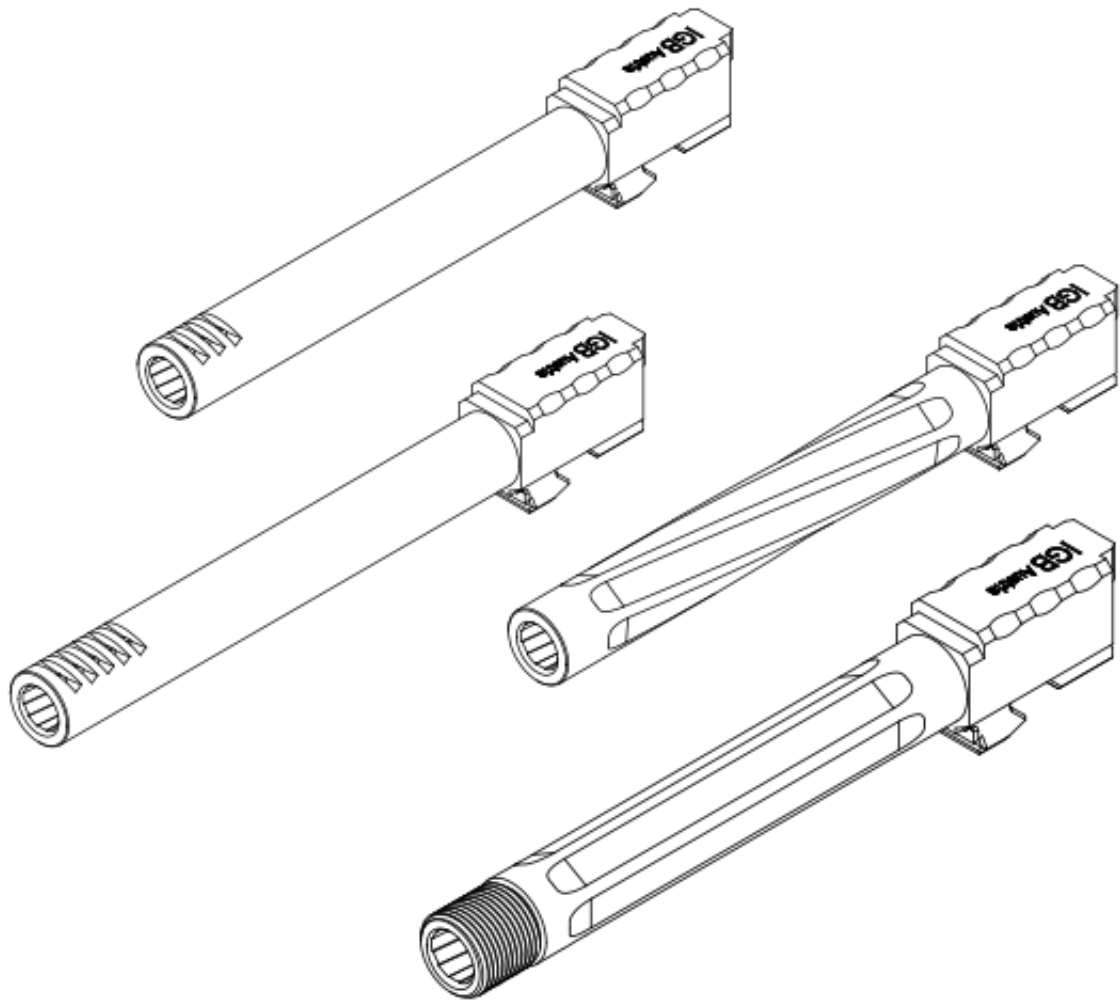

**Additional Options /
 Zusätzliche Optionen**

	Price / Preis
Straight Fluted / Geradegeflutet	Base +A03
Twisted Fluted / Spiralgeflutet	Base +A03
3 Muzzleports / 3 Mündungsschlitze	Base +A02
5 Muzzleports / 5 Mündungsschlitze	Base +A02

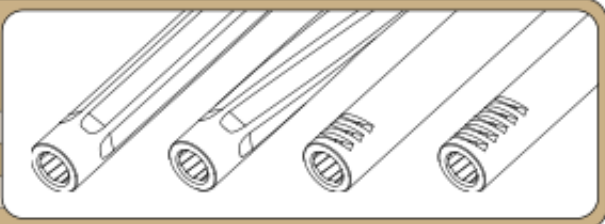

**Add Custom Surface
 Oberflächenoptionen**

	Price / Preis
PVD (Gold, Silver, Tan, Bronze, ...)	Base + A05
Sandblast / Sandgestrahlt	Base +A04
Twisted Fluted / Spiralgeflutet	Base +A02
Straight Fluted / Geradegeflutet	Base +A02

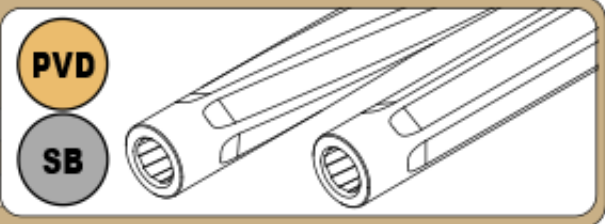

IGB BARRELS FOR GLOCK

Glock 22 Gen. 2 - Gen. 4



G22 40 S&W Gen. 2- Gen. 4

IGB Austria

Glock 22 Gen. 2 – Gen. 4 Standard Length (114 MM)

Order No. Artikelnr.	From Von	Inner Profile Innenprofil	To Zu	Length Länge	Price Preis
22A-H040-S114	40 S&W	Hexagonal	40 S&W	114 MM	H
22A-H357-S114	40 S&W	Hexagonal	357 Sig	114 MM	H
22A-P357-S114	40 S&W	Polygonal	357 Sig	114 MM	H
22A-H919-S114	40 S&W	Hexagonal	9x19	114 MM	H
22A-P919-S114	40 S&W	Polygonal	9x19	114 MM	H
22A-H765-S114	40 S&W	Hexagonal	7,65 Para	114 MM	H

Glock 22 Gen. 2 – Gen. 4 L=153 MM (6")

Order No. Artikelnr.	From Von	Inner Profile Innenprofil	To Zu	Length Länge	Price Preis
22A-H040-153	40 S&W	Hexagonal	40 S&W	153 MM	I
22A-H357-153	40 S&W	Hexagonal	357 Sig	153 MM	I
22A-P357-153	40 S&W	Polygonal	357 Sig	153 MM	I
22A-H919-153	40 S&W	Hexagonal	9x19	153 MM	I
22A-P919-153	40 S&W	Polygonal	9x19	153 MM	I
22A-H765-153	40 S&W	Hexagonal	7,65 Para	153 MM	I

Glock 22 Gen. 2 – Gen. 4 L=191 MM (7.5")

Order No. Artikelnr.	From Von	Inner Profile Innenprofil	To Zu	Length Länge	Price Preis
22A-H040-191	40 S&W	Hexagonal	40 S&W	191 MM	J
22A-H357-191	40 S&W	Hexagonal	357 Sig	191 MM	J
22A-P357-191	40 S&W	Polygonal	357 Sig	191 MM	J
22A-H919-191	40 S&W	Hexagonal	9x19	191 MM	J
22A-P919-191	40 S&W	Polygonal	9x19	191 MM	J
22A-H765-191	40 S&W	Hexagonal	7,65 Para	191 MM	J

Caliberchange Kaliberwechsel

Magazine directly from us!
Magazin gleich bei uns mitbestellen!

Changing from bigger to smaller cartridge bottom will require you to get a smaller Magazine!
Example; .357 Sig to 9x19 = Magazine needed / .40 to .357 Sig = No Magazine needed

Wechsel von bestimmten Patronenbodendurchmessern benötigt ein Magazin!
Beispiel; .357 Sig zu 9x19 = Magazin benötigt / .40 zu .357.Sig = Kein Magazin benötigt

IGB BARRELS FOR GLOCK

Glock 22 Gen. 2 - Gen. 4

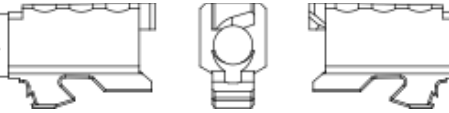

IGB Austria

Glock 22 Gen. 2 – Gen. 4 Threaded / Gewinde L=128 MM (5“)

Caliber Kaliber	Profile Profil	Threading Gewinde	Order No. Artikelnr.	Threading Gewinde	Order No. Artikelnr.	Price Preis
40 S&W	Hexa	M13x1	22A-H040-128-G02	M14x1	22A-H040-128-G05	H+A01
357 Sig	Hexa	M13x1	22A-H357-128-G02	M14x1	22A-H357-128-G05	H+A01
357 Sig	Poly	M13x1	22A-P357-128-G02	M14x1	22A-P357-128-G05	H+A01
9x19	Hexa	M13x1	22A-P919-128-G02	M14x1	22A-P919-128-G05	H+A01
9x19	Poly	M13x1	22A-H919-128-G02	M14x1	22A-H919-128-G05	H+A01
7,65 Para	Hexa	M13x1	22A-H765-128-G02	M14x1	22A-H765-128-G05	H+A01

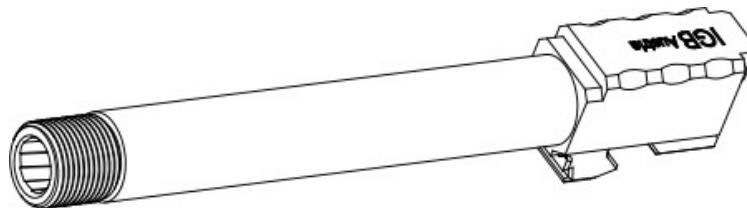

Glock 22 Gen. 2 – Gen. 4 Threaded / Gewinde L=128 MM (5“)

Caliber Kaliber	Profile Profil	Threading Gewinde	Order No. Artikelnr.	Threading Gewinde	Order No. Artikelnr.	Price Preis
40 S&W	Hexa	1/2x28	22A-H040-128-G01	13,5x1L	22A-H040-128-G04	H+A01
357 Sig	Hexa	1/2x28	22A-H357-128-G01	13,5x1L	22A-H357-128-G04	H+A01
357 Sig	Poly	1/2x28	22A-P357-128-G01	13,5x1L	22A-P357-128-G04	H+A01
9x19	Hexa	1/2x28	22A-P919-128-G01	13,5x1L	22A-P919-128-G04	H+A01
9x19	Poly	1/2x28	22A-H919-128-G01	13,5x1L	22A-H919-128-G04	H+A01
7,65 Para	Hexa	1/2x28	22A-H765-128-G01	13,5x1L	22A-H765-128-G04	H+A01

More threadings on request / Mehr Gewinde auf Anfrage

Accessories / Zubehör

	Price / Preis
Model Shark	A09
Model Shark Compact	A09
Steel Thread Protector	A08

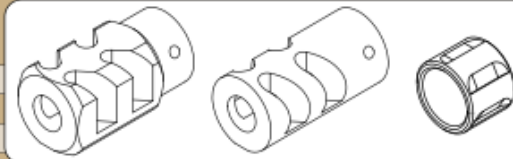

Add Custom Surface Oberflächenoptionen

	Price / Preis
PVD (Gold, Silver, Tan, Bronze, ...)	Base + A05
Sandblast / Sandgestrahlt	Base + A04
Twisted Fluted / Spiralgefütet	Base + A02
Straight Fluted / Geradegefütet	Base + A02

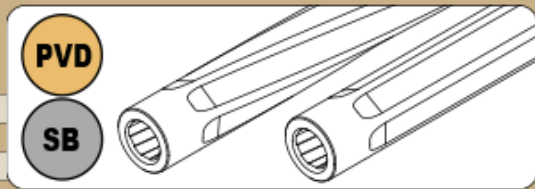

IGB BARRELS FOR GLOCK

Glock 22 Gen. 2 - Gen. 4

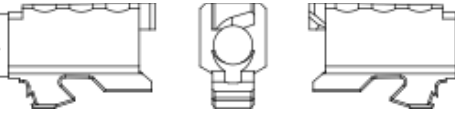

IGB Austria

Glock 22 Gen. 2 – Gen. 4 L=255 MM (10“) with 1/2x28 UNEF

Order No. Artikelnr.	From Von	Inner Profile Innenprofil	To Zu	Length Länge	Price Preis
22A-H040-255	40 S&W	Hexagonal	40 S&W	255 MM	K
22A-H357-255	40 S&W	Hexagonal	357 Sig	255 MM	K
22A-P357-255	40 S&W	Polygonal	357 Sig	255 MM	K
22A-H919-255	40 S&W	Hexagonal	9x19	255 MM	K
22A-P919-255	40 S&W	Polygonal	9x19	255 MM	K

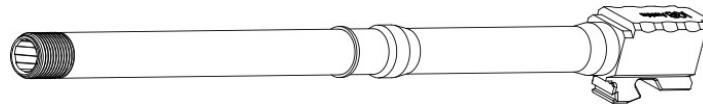

Accessories 10" Zubehör 255 MM

	Price / Preis
Muzzledevice / Schwingungsdämpfer	A09
Ported Shroud 10" / Laufmantel Geportet 255 MM	A12
Steel Thread Protector / Gewindeschutz	A08



Glock 22 Gen. 2 – Gen. 4 L=410 MM (16“) with 1/2x28 UNEF

Order No. Artikelnr.	From Von	Inner Profile Innenprofil	To Zu	Length Länge	Price Preis
22A-H040-410	40 S&W	Hexagonal	40 S&W	410 MM	L
22A-H357-410	40 S&W	Hexagonal	357 Sig	410 MM	L
22A-P357-410	40 S&W	Polygonal	357 Sig	410 MM	L
22A-H919-410	40 S&W	Hexagonal	9x19	410 MM	L
22A-P919-410	40 S&W	Polygonal	9x19	410 MM	L

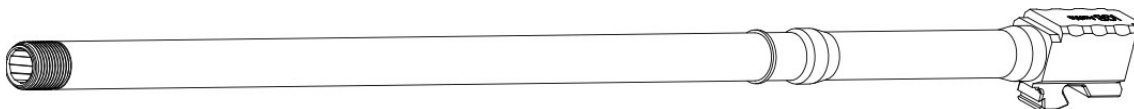

Accessories 16" Zubehör 410 MM

	Price / Preis
Muzzledevice / Schwingungsdämpfer	A09
Ported Shroud 16" / Laufmantel Geportet 410 MM	A13
Steel Thread Protector / Gewindeschutz	A08



IGB BARRELS FOR GLOCK

Glock 22 Gen. 5

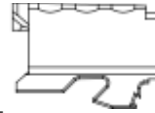
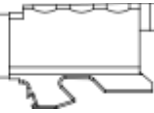

IGB Austria

G22 40 S&W Gen. 5

Glock 22 Gen. 5 Standard Length (114 MM)

Order No. Artikelnr.	From Von	Inner Profile Innenprofil	To Zu	Length Länge	Price Preis
22B-H040-S114	40 S&W	Hexagonal	40 S&W	114 MM	H
22B-H357-S114	40 S&W	Hexagonal	357 Sig	114 MM	H
22B-P357-S114	40 S&W	Polygonal	357 Sig	114 MM	H
22B-H919-S114	40 S&W	Hexagonal	9x19	114 MM	H
22B-P919-S114	40 S&W	Polygonal	9x19	114 MM	H
22B-H765-S114	40 S&W	Hexagonal	7,65 Para	114 MM	H

Glock 22 Gen. 5 L=153 MM (6")

Order No. Artikelnr.	From Von	Inner Profile Innenprofil	To Zu	Length Länge	Price Preis
22B-H040-153	40 S&W	Hexagonal	40 S&W	153 MM	I
22B-H357-153	40 S&W	Hexagonal	357 Sig	153 MM	I
22B-P357-153	40 S&W	Polygonal	357 Sig	153 MM	I
22B-H919-153	40 S&W	Hexagonal	9x19	153 MM	I
22B-P919-153	40 S&W	Polygonal	9x19	153 MM	I
22B-H765-153	40 S&W	Hexagonal	7,65 Para	153 MM	I

Glock 22 Gen. 5 L=191 MM (7.5")

Order No. Artikelnr.	From Von	Inner Profile Innenprofil	To Zu	Length Länge	Price Preis
22B-H040-191	40 S&W	Hexagonal	40 S&W	191 MM	J
22B-H357-191	40 S&W	Hexagonal	357 Sig	191 MM	J
22B-P357-191	40 S&W	Polygonal	357 Sig	191 MM	J
22B-H919-191	40 S&W	Hexagonal	9x19	191 MM	J
22B-P919-191	40 S&W	Polygonal	9x19	191 MM	J
22B-H765-191	40 S&W	Hexagonal	7,65 Para	191 MM	J

Caliberchange Kaliberwechsel

**Magazine directly from us!
Magazin gleich bei uns mitbestellen!**

Changing from bigger to smaller cartridge bottom will require you to get a smaller Magazine!
Example; **.357 Sig to 9x19 = Magazine needed / .40 to .357 Sig = No Magazine needed**

Wechsel von bestimmten Patronenbodendurchmessern benötigt ein Magazin!
Beispiel; **.357 Sig zu 9x19 = Magazin benötigt / .40 zu .357.Sig = Kein Magazin benötigt**

IGB BARRELS FOR GLOCK

Glock 22 Gen. 5

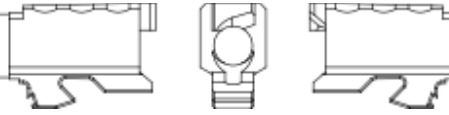

IGB Austria

Glock 22 Gen. 5 Threaded / Gewinde L=128 MM (5")

Caliber Kaliber	Profile Profil	Threading Gewinde	Order No. Artikelnr.	Threading Gewinde	Order No. Artikelnr.	Price Preis
40 S&W	Hexa	M13x1	22B-H040-128-G02	M14x1	22B-H040-128-G05	H+A01
357 Sig	Hexa	M13x1	22B-H357-128-G02	M14x1	22B-H357-128-G05	H+A01
357 Sig	Poly	M13x1	22B-P357-128-G02	M14x1	22B-P357-128-G05	H+A01
9x19	Hexa	M13x1	22B-P919-128-G02	M14x1	22B-P919-128-G05	H+A01
9x19	Poly	M13x1	22B-H919-128-G02	M14x1	22B-H919-128-G05	H+A01
7,65 Para	Hexa	M13x1	22B-H765-128-G02	M14x1	22B-H765-128-G05	H+A01

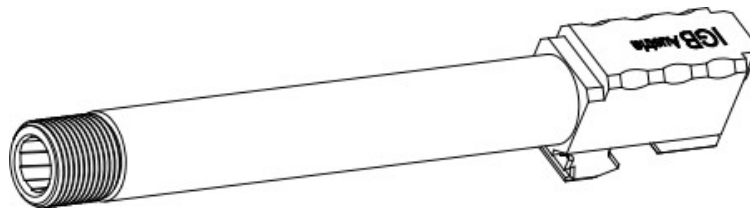

Glock 22 Gen. 5 Threaded / Gewinde L=128 MM (5")

Caliber Kaliber	Profile Profil	Threading Gewinde	Order No. Artikelnr.	Threading Gewinde	Order No. Artikelnr.	Price Preis
40 S&W	Hexa	1/2x28	22B-H040-128-G01	13,5x1L	22B-H040-128-G04	H+A01
357 Sig	Hexa	1/2x28	22B-H357-128-G01	13,5x1L	22B-H357-128-G04	H+A01
357 Sig	Poly	1/2x28	22B-P357-128-G01	13,5x1L	22B-P357-128-G04	H+A01
9x19	Hexa	1/2x28	22B-P919-128-G01	13,5x1L	22B-P919-128-G04	H+A01
9x19	Poly	1/2x28	22B-H919-128-G01	13,5x1L	22B-H919-128-G04	H+A01
7,65 Para	Hexa	1/2x28	22B-H765-128-G01	13,5x1L	22B-H765-128-G04	H+A01

More threadings on request / Mehr Gewinde auf Anfrage

Accessories / Zubehör

	Price / Preis
Model Shark	A09
Model Shark Compact	A09
Steel Thread Protector	A08

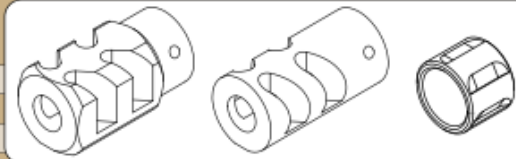

Add Custom Surface
Oberflächenoptionen

	Price / Preis
PVD (Gold, Silver, Tan, Bronze, ...)	Base + A05
Sandblast / Sandgestrahlt	Base + A04
Twisted Fluted / Spiralgefütet	Base + A02
Straight Fluted / Geradegefütet	Base + A02

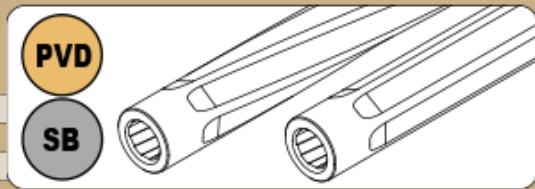

IGB BARRELS FOR GLOCK

Glock 22 Gen. 5

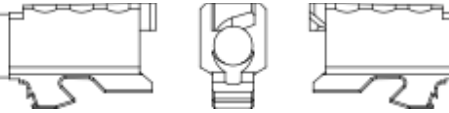

IGB Austria

Glock 22 Gen. 5 L=255 MM (10") with 1/2x28 UNEF

Order No. Artikelnr.	From Von	Inner Profile Innenprofil	To Zu	Length Länge	Price Preis
22B-H040-255	40 S&W	Hexagonal	40 S&W	255 MM	K
22B-H357-255	40 S&W	Hexagonal	357 Sig	255 MM	K
22B-P357-255	40 S&W	Polygonal	357 Sig	255 MM	K
22B-H919-255	40 S&W	Hexagonal	9x19	255 MM	K
22B-P919-255	40 S&W	Polygonal	9x19	255 MM	K

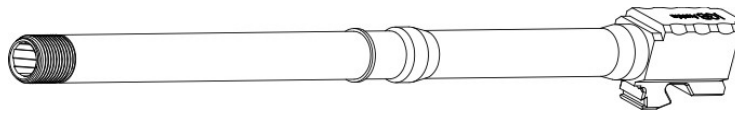

Accessories 10" Zubehör 255 MM

	Price / Preis
Muzzledevice / Schwingungsdämpfer	A09
Ported Shroud 10" / Laufmantel Geportet 255 MM	A12
Steel Thread Protector / Gewindeschutz	A08

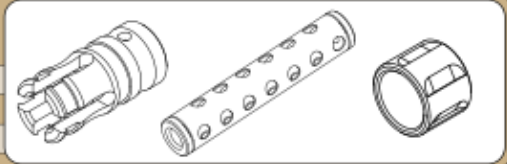

Glock 22 Gen. 5 L=410 MM (16") with 1/2x28 UNEF

Order No. Artikelnr.	From Von	Inner Profile Innenprofil	To Zu	Length Länge	Price Preis
22B-H040-410	40 S&W	Hexagonal	40 S&W	410 MM	L
22B-H357-410	40 S&W	Hexagonal	357 Sig	410 MM	L
22B-P357-410	40 S&W	Polygonal	357 Sig	410 MM	L
22B-H919-410	40 S&W	Hexagonal	9x19	410 MM	L
22B-P919-410	40 S&W	Polygonal	9x19	410 MM	L

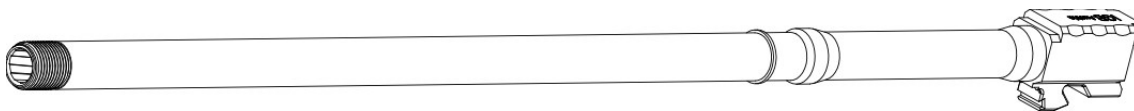

Accessories 16" Zubehör 410 MM

	Price / Preis
Muzzledevice / Schwingungsdämpfer	A09
Ported Shroud 16" / Laufmantel Geportet 410 MM	A13
Steel Thread Protector / Gewindeschutz	A08

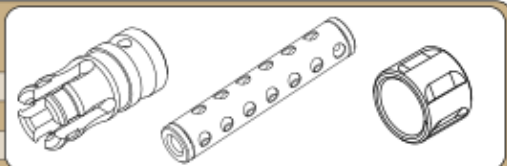

IGB BARRELS IDEAS

Make it YOUR Gun with the IGB Variety
 Machen Sie es zu IHRER Pistole mit den IGB Variationen.

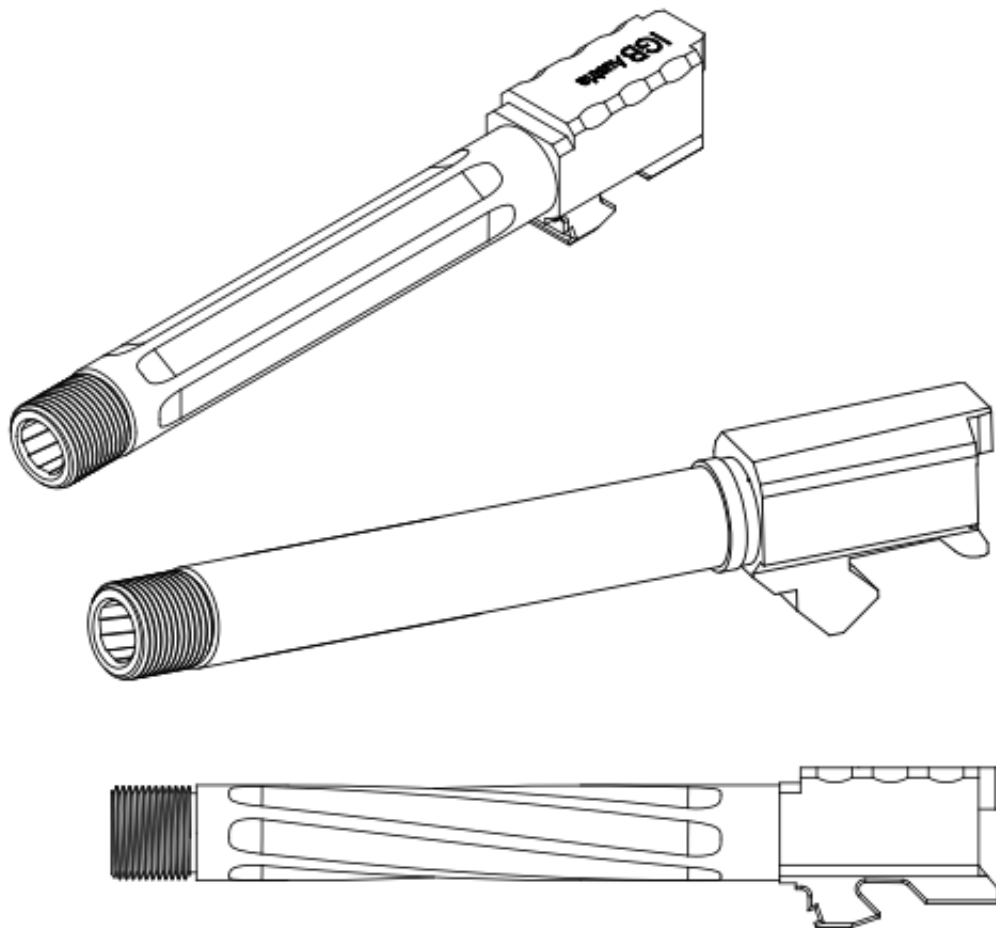

Accessories / Zubehör

	Price / Preis
Model Shark	A09
Model Shark Compact	A09
Steel Thread Protector	A08

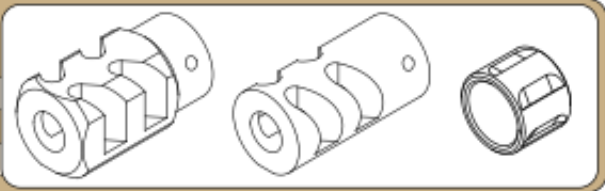

Add Custom Surface Oberflächenoptionen

	Price / Preis
PVD (Gold, Silver, Tan, Bronze, ...)	Base + A05
Sandblast / Sandgestrahlt	Base +A04
Twisted Fluted / Spiralfelutet	Base +A02
Straight Fluted / Geradegefutet	Base +A02

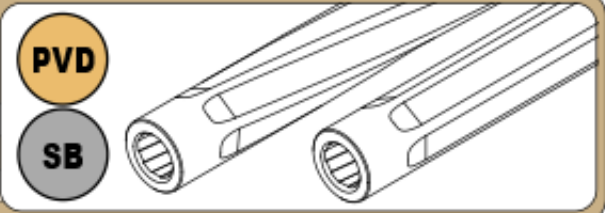

PVD

SB

IGB BARRELS FOR GLOCK

Glock 23 Gen. 2 - Gen.4

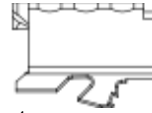
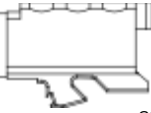

IGB Austria

G23 40 S&W Gen. 2- Gen. 4

Glock 23 Gen. 2 – Gen. 4 Standard Length (102 MM)

Order No. Artikelnr.	From Von	Inner Profile Innenprofil	To Zu	Length Länge	Price Preis
23A-H040-S102	40 S&W	Hexagonal	40 S&W	102 MM	H
23A-H357-S102	40 S&W	Hexagonal	357 Sig	102 MM	H
23A-P357-S102	40 S&W	Polygonal	357 Sig	102 MM	H
23A-H919-S102	40 S&W	Hexagonal	9x19	102 MM	H
23A-P919-S102	40 S&W	Polygonal	9x19	102 MM	H
23A-H765-S102	40 S&W	Hexagonal	7,65 Para	102 MM	H

Glock 23 Gen. 2 – Gen. 4 L=153 MM (6")

Order No. Artikelnr.	From Von	Inner Profile Innenprofil	To Zu	Length Länge	Price Preis
23A-H040-153	40 S&W	Hexagonal	40 S&W	153 MM	I
23A-H357-153	40 S&W	Hexagonal	357 Sig	153 MM	I
23A-P357-153	40 S&W	Polygonal	357 Sig	153 MM	I
23A-H919-153	40 S&W	Hexagonal	9x19	153 MM	I
23A-P919-153	40 S&W	Polygonal	9x19	153 MM	I
23A-H765-153	40 S&W	Hexagonal	7,65 Para	153 MM	I

Glock 23 Gen. 2 – Gen. 4 L=191 MM (7.5")

Order No. Artikelnr.	From Von	Inner Profile Innenprofil	To Zu	Length Länge	Price Preis
23A-H040-191	40 S&W	Hexagonal	40 S&W	191 MM	J
23A-H357-191	40 S&W	Hexagonal	357 Sig	191 MM	J
23A-P357-191	40 S&W	Polygonal	357 Sig	191 MM	J
23A-H919-191	40 S&W	Hexagonal	9x19	191 MM	J
23A-P919-191	40 S&W	Polygonal	9x19	191 MM	J
23A-H765-191	40 S&W	Hexagonal	7,65 Para	191 MM	J

Caliberchange Kaliberwechsel

**Magazine directly from us!
Magazin gleich bei uns mitbestellen!**

Changing from bigger to smaller cartridge bottom will require you to get a smaller Magazine!
Example; **.357 Sig to 9x19 = Magazine needed / .40 to .357 Sig = No Magazine needed**

Wechsel von bestimmten Patronenbodendurchmessern benötigt ein Magazin!
Beispiel; **.357 Sig zu 9x19 = Magazin benötigt / .40 zu .357.Sig = Kein Magazin benötigt**

IGB BARRELS FOR GLOCK

Glock 23 Gen. 2 - Gen.4

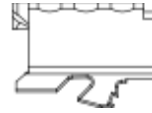
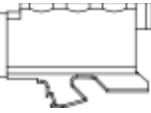

IGB Austria

Glock 23 Gen. 2 – Gen. 4 Threaded / Gewinde L=116 MM (4.6“)

Caliber Kaliber	Profile Profil	Threading Gewinde	Order No. Artikelnr.	Threading Gewinde	Order No. Artikelnr.	Price Preis
40 S&W	Hexa	M13x1	23A-H040-116-G02	M14x1	23A-H040-116-G05	H+A01
357 Sig	Hexa	M13x1	23A-H357-116-G02	M14x1	23A-H357-116-G05	H+A01
357 Sig	Poly	M13x1	23A-P357-116-G02	M14x1	23A-P357-116-G05	H+A01
9x19	Hexa	M13x1	23A-H919-116-G02	M14x1	23A-H919-116-G05	H+A01
9x19	Poly	M13x1	23A-P919-116-G02	M14x1	23A-P919-116-G05	H+A01
7,65 Para	Hexa	M13x1	23A-H765-116-G02	M14x1	23A-H765-116-G05	H+A01

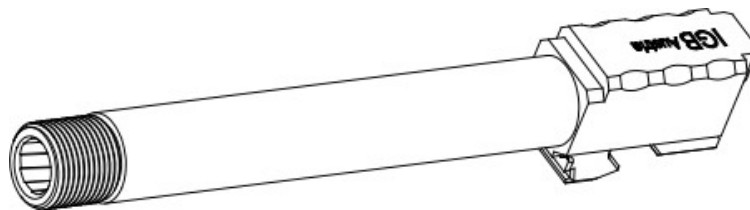

Glock 23 Gen. 2 – Gen. 4 Threaded / Gewinde L=116 MM (4.6“)

Caliber Kaliber	Profile Profil	Threading Gewinde	Order No. Artikelnr.	Threading Gewinde	Order No. Artikelnr.	Price Preis
40 S&W	Hexa	1/2x28	23A-H040-116-G01	13,5x1L	23A-H040-116-G04	H+A01
357 Sig	Hexa	1/2x28	23A-H357-116-G01	13,5x1L	23A-H357-116-G04	H+A01
357 Sig	Poly	1/2x28	23A-P357-116-G01	13,5x1L	23A-P357-116-G04	H+A01
9x19	Hexa	1/2x28	23A-H919-116-G01	13,5x1L	23A-H919-116-G04	H+A01
9x19	Poly	1/2x28	23A-P919-116-G01	13,5x1L	23A-P919-116-G04	H+A01
7,65 Para	Hexa	1/2x28	23A-H765-116-G01	13,5x1L	23A-H765-116-G04	H+A01

More threadings on request / Mehr Gewinde auf Anfrage

Accessories / Zubehör

	Price / Preis
Model Shark	A09
Model Shark Compact	A09
Steel Thread Protector	A08

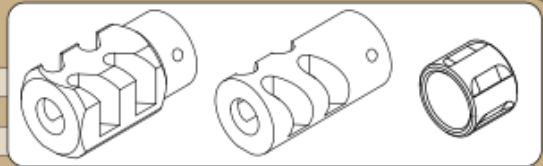

**Add Custom Surface
Oberflächenoptionen**

	Price / Preis
PVD (Gold, Silver, Tan, Bronze, ...)	Base + A05
Sandblast / Sandgestrahlt	Base + A04
Twisted Fluted / Spiralgefütet	Base + A02
Straight Fluted / Geradegefütet	Base + A02

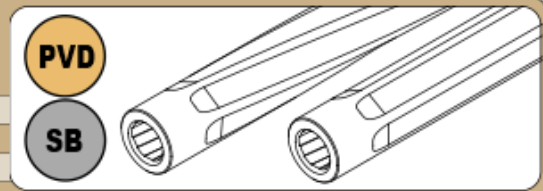

IGB BARRELS FOR GLOCK

Glock 23 Gen. 2 - Gen.4

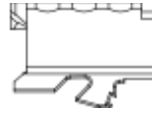
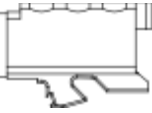

IGB Austria

Glock 23 Gen. 2 – Gen. 4 L=255 MM (10“) with 1/2x28 UNEF

Order No. Artikelnr.	From Von	Inner Profile Innenprofil	To Zu	Length Länge	Price Preis
23A-H040-255	40 S&W	Hexagonal	40 S&W	255 MM	K
23A-H357-255	40 S&W	Hexagonal	357 Sig	255 MM	K
23A-P357-255	40 S&W	Polygonal	357 Sig	255 MM	K
23A-H919-255	40 S&W	Hexagonal	9x19	255 MM	K
23A-P919-255	40 S&W	Polygonal	9x19	255 MM	K

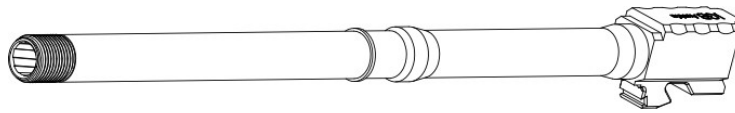

Accessories 10" Zubehör 255 MM

	Price / Preis
Muzzledevice / Schwingungsdämpfer	A09
Ported Shroud 10" / Laufmantel Geportet 255 MM	A12
Steel Thread Protector / Gewindeschutz	A08

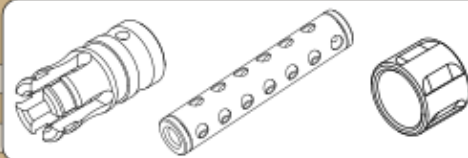

Glock 23 Gen. 2 – Gen. 4 L=410 MM (16“) with 1/2x28 UNEF

Order No. Artikelnr.	From Von	Inner Profile Innenprofil	To Zu	Length Länge	Price Preis
23A-H040-410	40 S&W	Hexagonal	40 S&W	410 MM	L
23A-H357-410	40 S&W	Hexagonal	357 Sig	410 MM	L
23A-P357-410	40 S&W	Polygonal	357 Sig	410 MM	L
23A-H919-410	40 S&W	Hexagonal	9x19	410 MM	L
23A-P919-410	40 S&W	Polygonal	9x19	410 MM	L

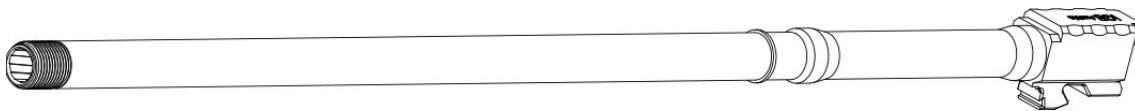

Accessories 16" Zubehör 410 MM

	Price / Preis
Muzzledevice / Schwingungsdämpfer	A09
Ported Shroud 16" / Laufmantel Geportet 410 MM	A13
Steel Thread Protector / Gewindeschutz	A08



IGB BARRELS FOR GLOCK

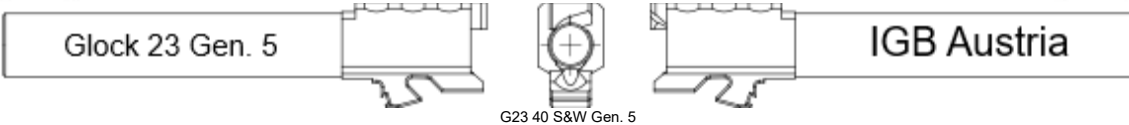

Glock 23 Gen. 5 Standard Length (102 MM)

Order No. Artikelnr.	From Von	Inner Profile Innenprofil	To Zu	Length Länge	Price Preis
23B-H040-S102	40 S&W	Hexagonal	40 S&W	102 MM	H
23B-H357-S102	40 S&W	Hexagonal	357 Sig	102 MM	H
23B-P357-S102	40 S&W	Polygonal	357 Sig	102 MM	H
23B-H919-S102	40 S&W	Hexagonal	9x19	102 MM	H
23B-P919-S102	40 S&W	Polygonal	9x19	102 MM	H
23B-H765-S102	40 S&W	Hexagonal	7,65 Para	102 MM	H

Glock 23 Gen. 5 L=153 MM (6")

Order No. Artikelnr.	From Von	Inner Profile Innenprofil	To Zu	Length Länge	Price Preis
23B-H040-153	40 S&W	Hexagonal	40 S&W	153 MM	I
23B-H357-153	40 S&W	Hexagonal	357 Sig	153 MM	I
23B-P357-153	40 S&W	Polygonal	357 Sig	153 MM	I
23B-H919-153	40 S&W	Hexagonal	9x19	153 MM	I
23B-P919-153	40 S&W	Polygonal	9x19	153 MM	I
23B-H765-153	40 S&W	Hexagonal	7,65 Para	153 MM	I

Glock 23 Gen. 5 L=191 MM (7.5")

Order No. Artikelnr.	From Von	Inner Profile Innenprofil	To Zu	Length Länge	Price Preis
23B-H040-191	40 S&W	Hexagonal	40 S&W	191 MM	J
23B-H357-191	40 S&W	Hexagonal	357 Sig	191 MM	J
23B-P357-191	40 S&W	Polygonal	357 Sig	191 MM	J
23B-H919-191	40 S&W	Hexagonal	9x19	191 MM	J
23B-P919-191	40 S&W	Polygonal	9x19	191 MM	J
23B-H765-191	40 S&W	Hexagonal	7,65 Para	191 MM	J

Caliberchange Kaliberwechsel

Magazine directly from us!
Magazin gleich bei uns mitbestellen!

Changing from bigger to smaller cartridge bottom will require you to get a smaller Magazine!
 Example; **.357 Sig to 9x19 = Magazine needed / .40 to .357 Sig = No Magazine needed**

Wechsel von bestimmten Patronenbodendurchmessern benötigt ein Magazin!
 Beispiel; **.357 Sig zu 9x19 = Magazin benötigt / .40 zu .357.Sig = Kein Magazin benötigt**

IGB BARRELS FOR GLOCK

Glock 23 Gen. 5

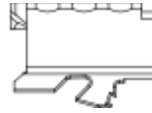
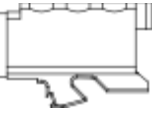

IGB Austria

Glock 23 Gen. 5 Threaded / Gewinde L=116 MM (4.6")

Caliber Kaliber	Profile Profil	Threading Gewinde	Order No. Artikelnr.	Threading Gewinde	Order No. Artikelnr.	Price Preis
40 S&W	Hexa	M13x1	23B-H040-116-G02	M14x1	23B-H040-116-G05	H+A01
357 Sig	Hexa	M13x1	23B-H357-116-G02	M14x1	23B-H357-116-G05	H+A01
357 Sig	Poly	M13x1	23B-P357-116-G02	M14x1	23B-P357-116-G05	H+A01
9x19	Hexa	M13x1	23B-H919-116-G02	M14x1	23B-H919-116-G05	H+A01
9x19	Poly	M13x1	23B-P919-116-G02	M14x1	23B-P919-116-G05	H+A01
7,65 Para	Hexa	M13x1	23B-H765-116-G02	M14x1	23B-H765-116-G05	H+A01

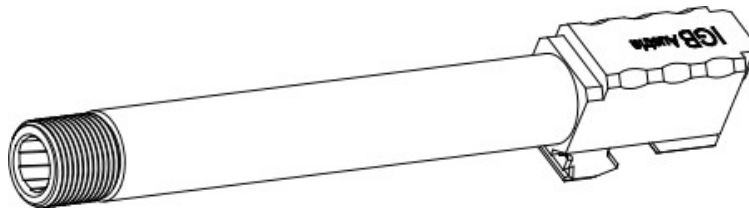

Glock 23 Gen. 5 Threaded / Gewinde L=116 MM (4.6")

Caliber Kaliber	Profile Profil	Threading Gewinde	Order No. Artikelnr.	Threading Gewinde	Order No. Artikelnr.	Price Preis
40 S&W	Hexa	1/2x28	23B-H040-116-G01	13,5x1L	23B-H040-116-G04	H+A01
357 Sig	Hexa	1/2x28	23B-H357-116-G01	13,5x1L	23B-H357-116-G04	H+A01
357 Sig	Poly	1/2x28	23B-P357-116-G01	13,5x1L	23B-P357-116-G04	H+A01
9x19	Hexa	1/2x28	23B-H919-116-G01	13,5x1L	23B-H919-116-G04	H+A01
9x19	Poly	1/2x28	23B-P919-116-G01	13,5x1L	23B-P919-116-G04	H+A01
7,65 Para	Hexa	1/2x28	23B-H765-116-G01	13,5x1L	23B-H765-116-G04	H+A01

More threadings on request / Mehr Gewinde auf Anfrage

Accessories / Zubehör

	Price / Preis
Model Shark	A09
Model Shark Compact	A09
Steel Thread Protector	A08

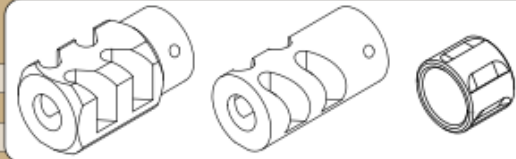

Add Custom Surface Oberflächenoptionen

	Price / Preis
PVD (Gold, Silver, Tan, Bronze, ...)	Base + A05
Sandblast / Sandgestrahlt	Base + A04
Twisted Fluted / Spiralgefütet	Base + A02
Straight Fluted / Geradegefütet	Base + A02

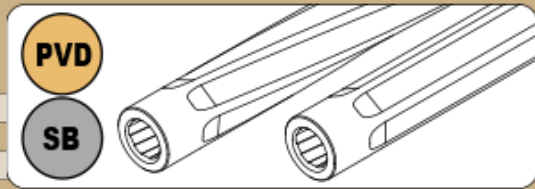

IGB BARRELS FOR GLOCK

Glock 23 Gen. 5

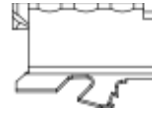
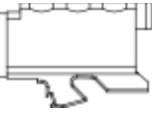

IGB Austria

Glock 23 Gen. 5 L=255 MM (10") with 1/2x28 UNEF

Order No. Artikelnr.	From Von	Inner Profile Innenprofil	To Zu	Length Länge	Price Preis
23B-H040-255	40 S&W	Hexagonal	40 S&W	255 MM	K
23B-H357-255	40 S&W	Hexagonal	357 Sig	255 MM	K
23B-P357-255	40 S&W	Polygonal	357 Sig	255 MM	K
23B-H919-255	40 S&W	Hexagonal	9x19	255 MM	K
23B-P919-255	40 S&W	Polygonal	9x19	255 MM	K

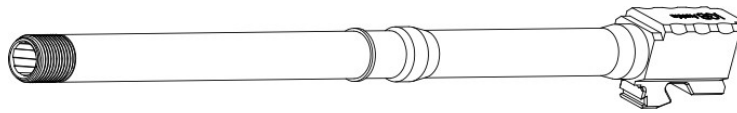
Accessories 10"
Zubehör 255 MM

	Price / Preis
Muzzledevice / Schwingungsdämpfer	A09
Ported Shroud 10" / Laufmantel Geportet 255 MM	A12
Steel Thread Protector / Gewindeschutz	A08

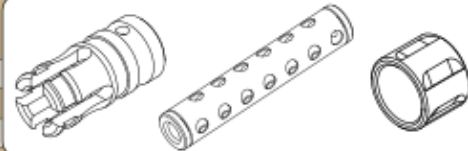

Glock 23 Gen. 5 L=410 MM (16") with 1/2x28 UNEF

Order No. Artikelnr.	From Von	Inner Profile Innenprofil	To Zu	Length Länge	Price Preis
23B-H040-410	40 S&W	Hexagonal	40 S&W	410 MM	L
23B-H357-410	40 S&W	Hexagonal	357 Sig	410 MM	L
23B-P357-410	40 S&W	Polygonal	357 Sig	410 MM	L
23B-H919-410	40 S&W	Hexagonal	9x19	410 MM	L
23B-P919-410	40 S&W	Polygonal	9x19	410 MM	L

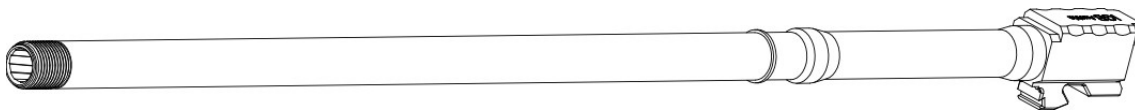
Accessories 16"
Zubehör 410 MM

	Price / Preis
Muzzledevice / Schwingungsdämpfer	A09
Ported Shroud 16" / Laufmantel Geportet 410 MM	A13
Steel Thread Protector / Gewindeschutz	A08

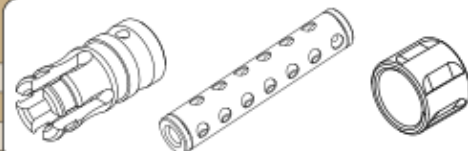

IGB BARRELS FOR GLOCK

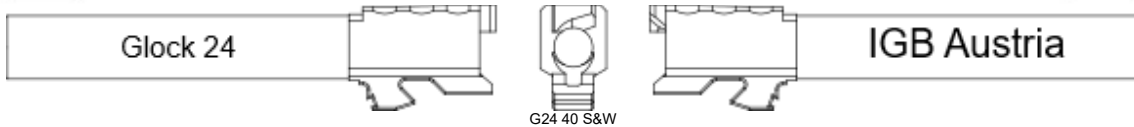

Glock 24 Standard Length (153 MM)

Order No. Artikelnr.	From Von	Inner Profile Innenprofil	To Zu	Length Länge	Price Preis
24A-H040-S153	40 S&W	Hexagonal	40 S&W	153 MM	I
24A-H357-S153	40 S&W	Hexagonal	357 Sig	153 MM	I
24A-P357-S153	40 S&W	Polygonal	357 Sig	153 MM	I
24A-H919-S153	40 S&W	Hexagonal	9x19	153 MM	I
24A-P919-S153	40 S&W	Polygonal	9x19	153 MM	I
24A-H765-S153	40 S&W	Hexagonal	7,65 Para	153 MM	I

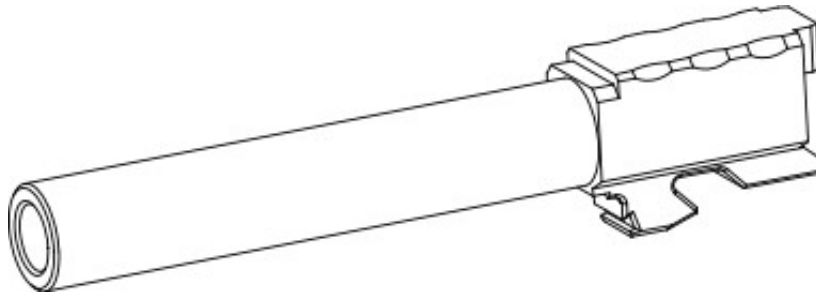

Glock 24 L=191 MM (7.5")

Order No. Artikelnr.	From Von	Inner Profile Innenprofil	To Zu	Length Länge	Price Preis
22A-H040-S153	40 S&W	Hexagonal	40 S&W	191 MM	J
22A-H357-S153	40 S&W	Hexagonal	357 Sig	191 MM	J
22A-P357-S153	40 S&W	Polygonal	357 Sig	191 MM	J
22A-H919-S153	40 S&W	Hexagonal	9x19	191 MM	J
22A-P919-S153	40 S&W	Polygonal	9x19	191 MM	J
22A-H765-S153	40 S&W	Hexagonal	7,65 Para	191 MM	J

Additional Options / Zusätzliche Optionen

Straight Fluted / Geradegefütet	Price / Preis Base +A03
Twisted Fluted / Spiralgefütet	Base +A03
3 Muzzleports / 3 Mündungsschlitze	Base +A02
5 Muzzleports / 5 Mündungsschlitze	Base +A02

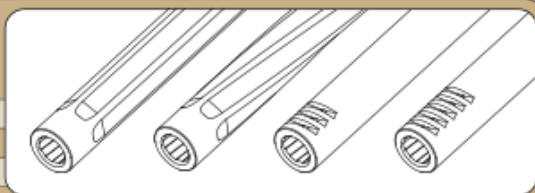

IGB BARRELS FOR GLOCK



Glock 24 Threaded / Gewinde L=167 MM (6.6")

Caliber Kaliber	Profile Profil	Threading Gewinde	Order No. Artikelnr.	Threading Gewinde	Order No. Artikelnr.	Price Preis
40 S&W	Hexa	M13x1	24A-H040-167-G02	M14x1	24A-H040-167-G05	H+A01
357 Sig	Hexa	M13x1	24A-H357-167-G02	M14x1	24A-H357-167-G05	H+A01
357 Sig	Poly	M13x1	24A-P357-167-G02	M14x1	24A-P357-167-G05	H+A01
9x19	Hexa	M13x1	24A-P919-167-G02	M14x1	24A-P919-167-G05	H+A01
9x19	Poly	M13x1	24A-H919-167-G02	M14x1	24A-H919-167-G05	H+A01
7,65 Para	Hexa	M13x1	24A-H765-167-G02	M14x1	24A-H765-167-G05	H+A01

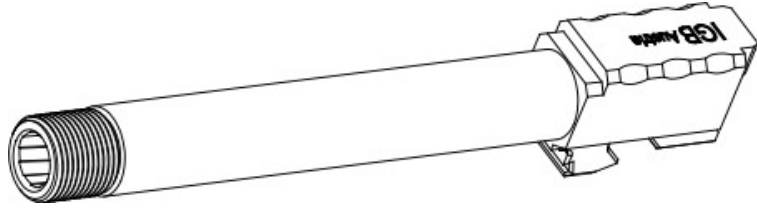

Glock 24 Threaded / Gewinde L=167 MM (6.6")

Caliber Kaliber	Profile Profil	Threading Gewinde	Order No. Artikelnr.	Threading Gewinde	Order No. Artikelnr.	Price Preis
40 S&W	Hexa	1/2x28	24A-H040-167-G01	13,5x1L	24A-H040-167-G01	H+A01
357 Sig	Hexa	1/2x28	24A-H357-167-G01	13,5x1L	24A-H357-167-G01	H+A01
357 Sig	Poly	1/2x28	24A-P357-167-G01	13,5x1L	24A-P357-167-G01	H+A01
9x19	Hexa	1/2x28	24A-P919-167-G01	13,5x1L	24A-P919-167-G01	H+A01
9x19	Poly	1/2x28	24A-H919-167-G01	13,5x1L	24A-H919-167-G01	H+A01
7,65 Para	Hexa	1/2x28	24A-H765-167-G01	13,5x1L	24A-H765-167-G01	H+A01

More threadings on request / Mehr Gewinde auf Anfrage

Accessories / Zubehör		Price / Preis
Model Shark		A09
Model Shark Compact		A09
Steel Thread Protector		A08

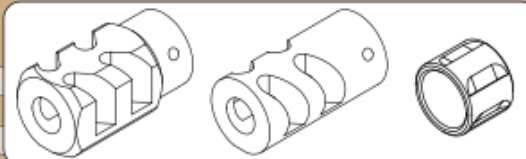

Add Custom Surface Oberflächenoptionen		Price / Preis
PVD (Gold, Silver, Tan, Bronze, ...)		Base + A05
Sandblast / Sandgestrahlt		Base + A04
Twisted Fluted / Spiralgefütet		Base + A02
Straight Fluted / Geradegefütet		Base + A02

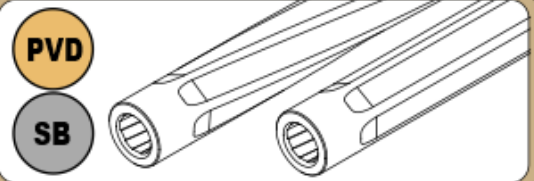

IGB BARRELS FOR GLOCK

Glock 24

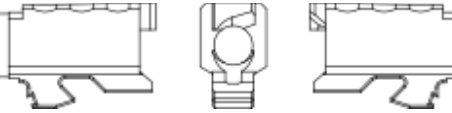

IGB Austria

Glock 24 L=255 MM (10") with 1/2x28 UNEF

Order No. Artikelnr.	From Von	Inner Profile Innenprofil	To Zu	Length Länge	Price Preis
22B-H040-255	40 S&W	Hexagonal	40 S&W	255 MM	K
22B-H357-255	40 S&W	Hexagonal	357 Sig	255 MM	K
22B-P357-255	40 S&W	Polygonal	357 Sig	255 MM	K
22B-H919-255	40 S&W	Hexagonal	9x19	255 MM	K
22B-P919-255	40 S&W	Polygonal	9x19	255 MM	K

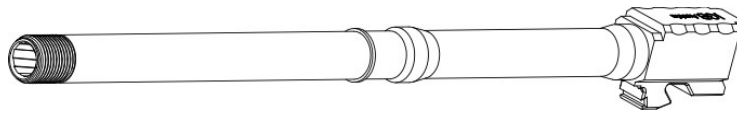

Accessories 10" Zubehör 255 MM

	Price / Preis
Muzzledevice / Schwingungsdämpfer	A09
Ported Shroud 10" / Laufmantel Geportet 255 MM	A12
Steel Thread Protector / Gewindeschutz	A08

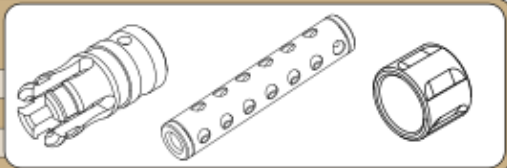

Glock 24 L=410 MM (16") with 1/2x28 UNEF

Order No. Artikelnr.	From Von	Inner Profile Innenprofil	To Zu	Length Länge	Price Preis
22B-H040-410	40 S&W	Hexagonal	40 S&W	410 MM	L
22B-H357-410	40 S&W	Hexagonal	357 Sig	410 MM	L
22B-P357-410	40 S&W	Polygonal	357 Sig	410 MM	L
22B-H919-410	40 S&W	Hexagonal	9x19	410 MM	L
22B-P919-410	40 S&W	Polygonal	9x19	410 MM	L

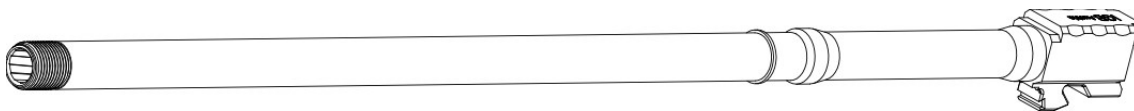

Accessories 16" Zubehör 410 MM

	Price / Preis
Muzzledevice / Schwingungsdämpfer	A09
Ported Shroud 16" / Laufmantel Geportet 410 MM	A13
Steel Thread Protector / Gewindeschutz	A08

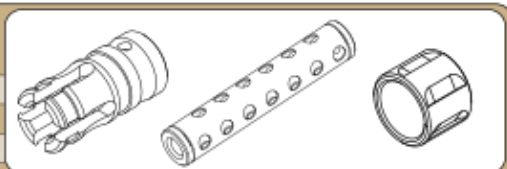

IGB BARRELS IDEAS

Make it YOUR Gun with the IGB Variety
 Machen Sie es zu IHRER Pistole mit den IGB Variationen.

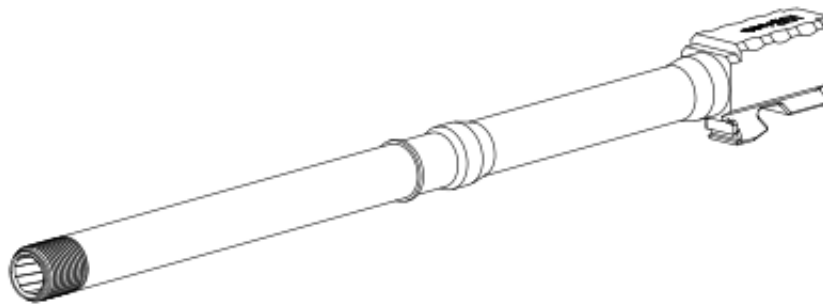

**Accessories 10"
 Zubehör 255 MM**

	Price / Preis
Muzzledevice / Schwingungsdämpfer	A09
Ported Shroud 10" / Laufmantel Geportet 255 MM	A12
Steel Thread Protector / Gewindeschutz	A08

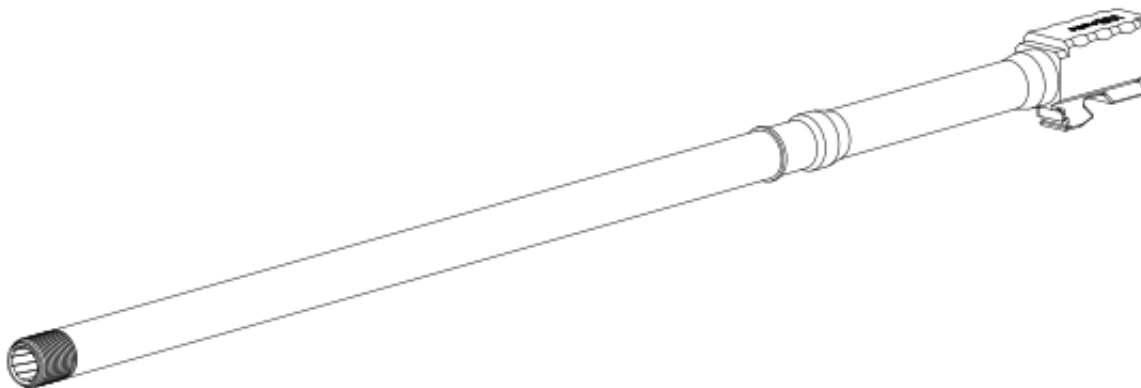
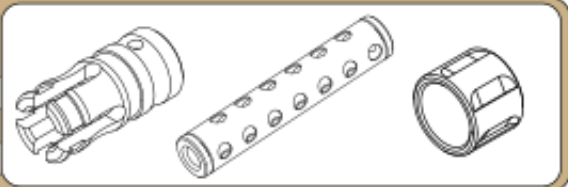

**Accessories 16"
 Zubehör 410 MM**

	Price / Preis
Muzzledevice / Schwingungsdämpfer	A09
Ported Shroud 16" / Laufmantel Geportet 410 MM	A13
Steel Thread Protector / Gewindeschutz	A08

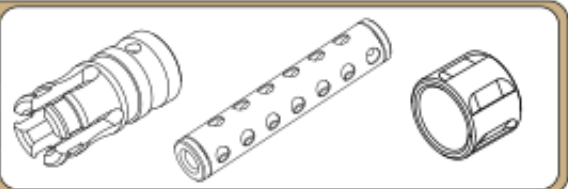

IGB BARRELS FOR GLOCK

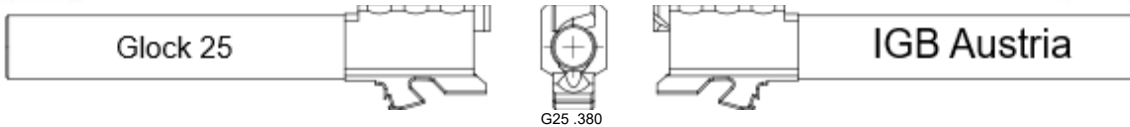

Glock 25 Standard Length (102 MM)

Order No. Artikelnr.	From Von	Inner Profile Innenprofil	To Zu	Length Länge	Price Preis
25A-P380-S102	.380	Polygonal	.380	102 MM	H
25A-H380-S102	.380	Hexagonal	.380	102 MM	H
25A-H765-S102	.380	Hexagonal	7,65 Para*	102 MM	H
25A-H9M-S102	.380	Hexagonal	9 Makarov*	102 MM	H

*9mm Magazine can be used / 9mm Magazin kann verwendet werden

Glock 25 Threaded / Gewinde L=116 MM (4.6")

Caliber Kaliber	Profile Profil	Threading Gewinde	Order No. Artikelnr.	Threading Gewinde	Order No. Artikelnr.	Price Preis
.380	Hexa	M13x1	25A-P380-116-G02	M14x1	25A-P380-116-G05	H+A01
.380	Poly	M13x1	25A-H380-116-G02	M14x1	25A-H380-116-G05	H+A01
7,65 Para	Hexa	M13x1	25A-H765-116-G02	M14x1	25A-H765-116-G05	H+A01
9 Mak	Hexa	M13x1	25A-H9M-116-G02	M14x1	25A-H9M-116-G05	H+A01

Glock 25 Threaded / Gewinde L=116 MM (4.6")

Caliber Kaliber	Profile Profil	Threading Gewinde	Order No. Artikelnr.	Threading Gewinde	Order No. Artikelnr.	Price Preis
.380	Hexa	1/2x28	25A-P380-116-G01	13,5x1L	25A-P380-116-G04	H+A01
.380	Poly	1/2x28	25A-H380-116-G01	13,5x1L	25A-H380-116-G04	H+A01
7,65 Para	Hexa	1/2x28	25A-H765-116-G01	13,5x1L	25A-H765-116-G04	H+A01
9 Mak	Hexa	1/2x28	25A-H9M-116-G01	13,5x1L	25A-H9M-116-G04	H+A01

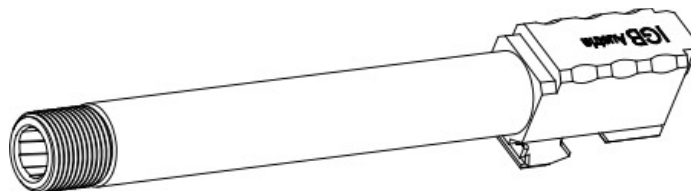

More threadings on request / Mehr Gewinde auf Anfrage

Add Custom Surface Oberflächenoptionen	Price / Preis
PVD (Gold, Silver, Tan, Bronze, ...)	Base + A05
Sandblast / Sandgestrahlt	Base + A04
Twisted Fluted / Spiralgefütet	Base + A02
Straight Fluted / Geradegefütet	Base + A02

PVD

SB

IGB BARRELS FOR GLOCK

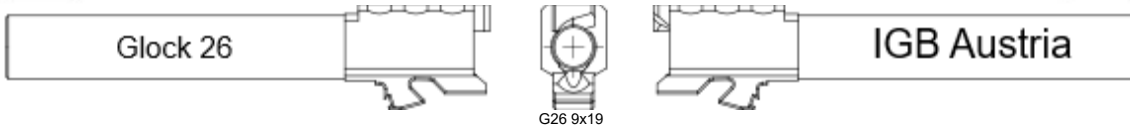

Glock 26 Standard Length (87 MM)

Order No. Artikelnr.	From Von	Inner Profile Innenprofil	To Zu	Length Länge	Price Preis
26A-P919-S087	9x19	Polygonal	9x19	87 MM	H
26A-H919-S087	9x19	Hexagonal	9x19	87 MM	H
26A-P380-S087	9x19	Polygonal	.380*	87 MM	H
26A-H380-S087	9x19	Hexagonal	.380*	87 MM	H
26A-H765-S087	9x19	Hexagonal	7,65 Para*	87 MM	H
26A-H9M-S087	9x19	Hexagonal	9 Makarov*	87 MM	H

*9mm Magazine can be used / 9mm Magazin kann verwendet werden

Glock 26 L=153 MM (6")

Order No. Artikelnr.	From Von	Inner Profile Innenprofil	To Zu	Length Länge	Price Preis
19A-P919-153	9x19	Polygonal	9x19	153 MM	H
19A-H919-153	9x19	Hexagonal	9x19	153 MM	H
19A-P380-153	9x19	Polygonal	.380*	153 MM	H
19A-H380-153	9x19	Hexagonal	.380*	153 MM	H
19A-H765-153	9x19	Hexagonal	7,65 Para*	153 MM	H
19A-H9M-153	9x19	Hexagonal	9 Makarov*	153 MM	H

*9mm Magazine can be used / 9mm Magazin kann verwendet werden

Glock 26 L=191 MM (7.5")

Order No. Artikelnr.	From Von	Inner Profile Innenprofil	To Zu	Length Länge	Price Preis
19A-P919-191	9x19	Polygonal	9x19	191 MM	J
19A-H919-191	9x19	Hexagonal	9x19	191 MM	J
19A-P919-191	9x19	Polygonal	9x21	191 MM	J
19A-H919-191	9x19	Hexagonal	9x21	191 MM	J



IGB BARRELS FOR GLOCK



Glock 26 Threaded / Gewinde L=101 MM (4")

Caliber Kaliber	Profile Profil	Threading Gewinde	Order No. Artikelnr.	Threading Gewinde	Order No. Artikelnr.	Price Preis
9x19	Hexa	M13x1	26A-P919-101-G02	M14x1	26A-P919-101-G05	H+A01
9x19	Poly	M13x1	26A-H919-101-G02	M14x1	26A-H919-101-G05	H+A01
.380	Hexa	M13x1	26A-H380-101-G02	M14x1	26A-H380-101-G05	H+A01
.380	Poly	M13x1	26A-P380-101-G02	M14x1	26A-P380-101-G05	H+A01
7,65 Para	Hexa	M13x1	26A-H765-101-G02	M14x1	26A-H765-101-G05	H+A01
9 Mak	Hexa	M13x1	26A-H9M-101-G02	M14x1	26A-H9M-101-G05	H+A01

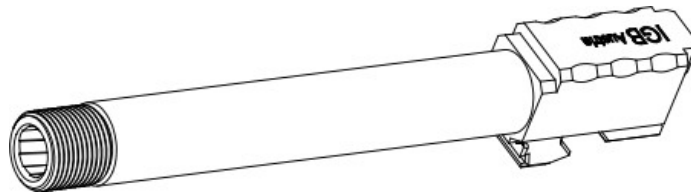

Glock 26 Threaded / Gewinde L=101 MM (4")

Caliber Kaliber	Profile Profil	Threading Gewinde	Order No. Artikelnr.	Threading Gewinde	Order No. Artikelnr.	Price Preis
9x19	Hexa	1/2x28	26A-P919-101-G01	13,5x1L	26A-P919-101-G04	H+A01
9x19	Poly	1/2x28	26A-H919-101-G01	13,5x1L	26A-H919-101-G04	H+A01
.380	Hexa	1/2x28	26A-H380-101-G01	13,5x1L	26A-H380-101-G04	H+A01
.380	Poly	1/2x28	26A-P380-101-G01	13,5x1L	26A-P380-101-G04	H+A01
7,65 Para	Hexa	1/2x28	26A-H765-101-G01	13,5x1L	26A-H765-101-G04	H+A01
9 Mak	Hexa	1/2x28	26A-H9M-101-G01	13,5x1L	26A-H9M-101-G04	H+A01

More threadings on request / Mehr Gewinde auf Anfrage

Accessories / Zubehör

	Price / Preis
Model Shark	A09
Model Shark Compact	A09
Steel Thread Protector	A08

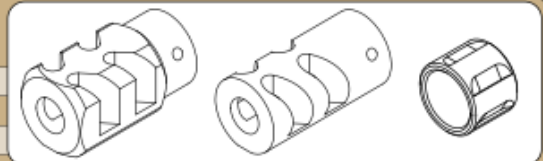

Add Custom Surface Oberflächenoptionen

	Price / Preis
PVD (Gold, Silver, Tan, Bronze, ...)	Base + A05
Sandblast / Sandgestrahlt	Base + A04
Twisted Fluted / Spiralgefütet	Base + A02
Straight Fluted / Geradegefütet	Base + A02

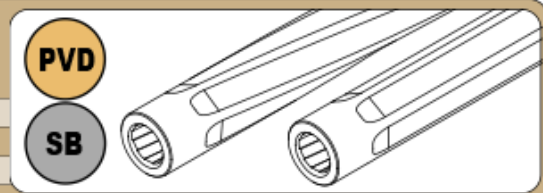

IGB BARRELS FOR GLOCK

Glock 27

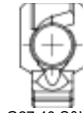
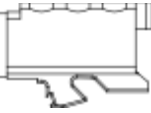

G27 40 S&W

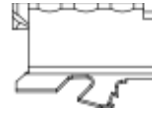

IGB Austria

Glock 27 Standard Length (87 MM)

Order No. Artikelnr.	From Von	Inner Profile Innenprofil	To Zu	Length Länge	Price Preis
27A-H040-S087	40 S&W	Hexagonal	40 S&W	87 MM	H
27A-H357-S087	40 S&W	Hexagonal	357 Sig	87 MM	H
27A-P357-S087	40 S&W	Polygonal	357 Sig	87 MM	H
27A-H919-S087	40 S&W	Hexagonal	9x19	87 MM	H
27A-P919-S087	40 S&W	Polygonal	9x19	87 MM	H
27A-H765-S087	40 S&W	Hexagonal	7,65 Para	87 MM	H

Glock 27 L=153 MM (6")

Order No. Artikelnr.	From Von	Inner Profile Innenprofil	To Zu	Length Länge	Price Preis
23A-H040-153	40 S&W	Hexagonal	40 S&W	153 MM	I
23A-H357-153	40 S&W	Hexagonal	357 Sig	153 MM	I
23A-P357-153	40 S&W	Polygonal	357 Sig	153 MM	I
23A-H919-153	40 S&W	Hexagonal	9x19	153 MM	I
23A-P919-153	40 S&W	Polygonal	9x19	153 MM	I
23A-H765-153	40 S&W	Hexagonal	7,65 Para	153 MM	I

Glock 27 L=191 MM (7.5")

Order No. Artikelnr.	From Von	Inner Profile Innenprofil	To Zu	Length Länge	Price Preis
23A-H040-191	40 S&W	Hexagonal	40 S&W	191 MM	J
23A-H357-191	40 S&W	Hexagonal	357 Sig	191 MM	J
23A-P357-191	40 S&W	Polygonal	357 Sig	191 MM	J
23A-H919-191	40 S&W	Hexagonal	9x19	191 MM	J
23A-P919-191	40 S&W	Polygonal	9x19	191 MM	J
23A-H765-191	40 S&W	Hexagonal	7,65 Para	191 MM	J

**Caliberchange
Kaliberwechsel**
**Magazine directly from us!
Magazin gleich bei uns mitbestellen!**

Changing from bigger to smaller cartridge bottom will require you to get a smaller Magazine!
Example; .357 Sig to 9x19 = Magazine needed / .40 to .357 Sig = No Magazine needed

Wechsel von bestimmten Patronenbodendurchmessern benötigt ein Magazin!
Beispiel; .357 Sig zu 9x19 = Magazin benötigt / .40 zu .357.Sig = Kein Magazin benötigt

IGB BARRELS FOR GLOCK

Glock 27

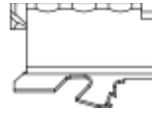
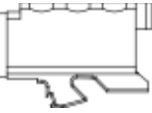

IGB Austria

Glock 27 Threaded / Gewinde L=101 MM (4")

Caliber Kaliber	Profile Profil	Threading Gewinde	Order No. Artikelnr.	Threading Gewinde	Order No. Artikelnr.	Price Preis
40 S&W	Hexa	M13x1	27A-H040-101-G02	M14x1	27A-H040-101-G05	H+A01
357 Sig	Hexa	M13x1	27A-H357-101-G02	M14x1	27A-H357-101-G05	H+A01
357 Sig	Poly	M13x1	27A-P357-101-G02	M14x1	27A-P357-101-G05	H+A01
9x19	Hexa	M13x1	27A-H919-101-G02	M14x1	27A-H919-101-G05	H+A01
9x19	Poly	M13x1	27A-P919-101-G02	M14x1	27A-P919-101-G05	H+A01
7,65 Para	Hexa	M13x1	27A-H765-101-G02	M14x1	27A-H765-101-G05	H+A01

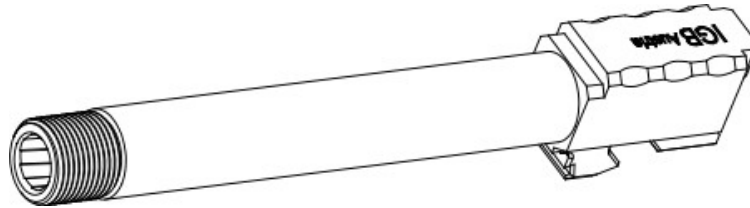

Glock 27 Threaded / Gewinde L=116 MM (4.6")

Caliber Kaliber	Profile Profil	Threading Gewinde	Order No. Artikelnr.	Threading Gewinde	Order No. Artikelnr.	Price Preis
40 S&W	Hexa	1/2x28	27A-H040-101-G01	13,5x1L	27A-H040-101-G04	H+A01
357 Sig	Hexa	1/2x28	27A-H357-101-G01	13,5x1L	27A-H357-101-G04	H+A01
357 Sig	Poly	1/2x28	27A-P357-101-G01	13,5x1L	27A-P357-101-G04	H+A01
9x19	Hexa	1/2x28	27A-H919-101-G01	13,5x1L	27A-H919-101-G04	H+A01
9x19	Poly	1/2x28	27A-P919-101-G01	13,5x1L	27A-P919-101-G04	H+A01
7,65 Para	Hexa	1/2x28	27A-H765-101-G01	13,5x1L	27A-H765-101-G04	H+A01

More threadings on request / Mehr Gewinde auf Anfrage

Accessories / Zubehör

	Price / Preis
Model Shark	A09
Model Shark Compact	A09
Steel Thread Protector	A08

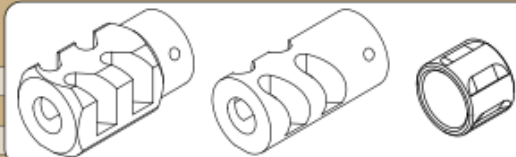

Add Custom Surface Oberflächenoptionen

	Price / Preis
PVD (Gold, Silver, Tan, Bronze, ...)	Base + A05
Sandblast / Sandgestrahlt	Base + A04
Twisted Fluted / Spiralgefütet	Base + A02
Straight Fluted / Geradegefütet	Base + A02

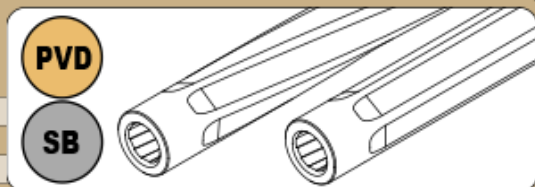

IGB BARRELS IDEAS

Make it YOUR Gun with the IGB Variety
 Machen Sie es zu IHRER Pistole mit den IGB Variationen.

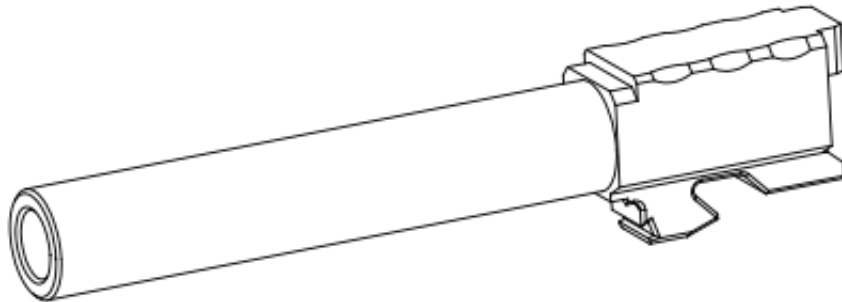

**Caliberchange
 Kaliberwechsel**

Order your Magazine directly from us!
 Magazin gleich bei uns mitbestellen!

Changing from a bigger cartridge bottom to a smaller one will require you to get a smaller Magazine!
 Example; .357 to 9x19 = Magazine needed / .40 to .357 = No Magazine needed

Wechsel von bestimmten Patronenbodendurchmessern benötigt ein Magazin!
 Beispiel; .357 zu 9x19 = Magazin benötigt / .40 zu .357 = Kein Magazin benötigt

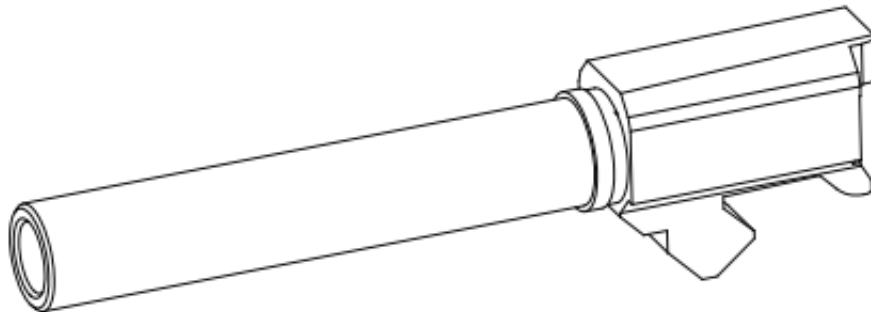

Polygonal vs Hexagonal

Polygonal is very smooth inside and therefore very gastight for high velocity.
 Polygonal ist formbedingt sehr Gasdicht für hohe Geschwindigkeiten.

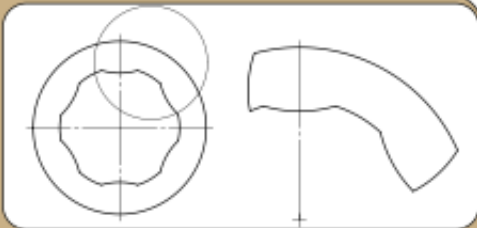
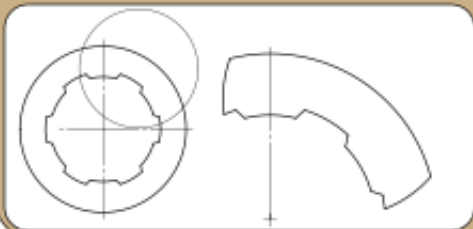

Hexagonal is the more classic approach and also well suited for pure lead.
 Hexagonal ist der klassischere Ansatz und gut geeignet für reine Bleigeschöße.

IGB BARRELS FOR GLOCK

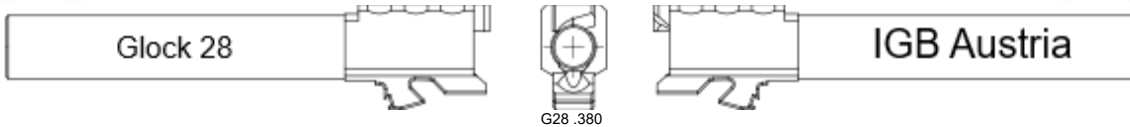

Glock 28 Standard Length (87 MM)

Order No. Artikelnr.	From Von	Inner Profile Innenprofil	To Zu	Length Länge	Price Preis
28A-P380-S087	.380	Polygonal	.380	87 MM	H
28A-H380-S087	.380	Hexagonal	.380	87 MM	H
28A-H765-S087	.380	Hexagonal	7,65 Para*	87 MM	H
28A-H9M-S087	.380	Hexagonal	9 Makarov*	87 MM	H

*9mm Magazine can be used / 9mm Magazin kann verwendet werden

Glock 28 Threaded / Gewinde L=101 MM (4")

Caliber Kaliber	Profile Profil	Threading Gewinde	Order No. Artikelnr.	Threading Gewinde	Order No. Artikelnr.	Price Preis
.380	Hexa	M13x1	28A-P380-101-G02	M14x1	28A-P380-101-G05	H+A01
.380	Poly	M13x1	28A-H380-1014-G02	M14x1	28A-H380-101-G05	H+A01
7,65 Para	Hexa	M13x1	28A-H765-101-G02	M14x1	28A-H765-101-G05	H+A01
9 Mak	Hexa	M13x1	28A-H9M-101-G02	M14x1	28A-H9M-101-G05	H+A01

Glock 28 Threaded / Gewinde L=101 MM (4")

Caliber Kaliber	Profile Profil	Threading Gewinde	Order No. Artikelnr.	Threading Gewinde	Order No. Artikelnr.	Price Preis
.380	Hexa	1/2x28	28A-P380-101-G01	13,5x1L	28A-P380-101-G04	H+A01
.380	Poly	1/2x28	28A-H380-101-G01	13,5x1L	28A-H380-101-G04	H+A01
7,65 Para	Hexa	1/2x28	28A-H765-101-G01	13,5x1L	28A-H765-101-G04	H+A01
9 Mak	Hexa	1/2x28	28A-H9M-101-G01	13,5x1L	28A-H9M-101-G04	H+A01

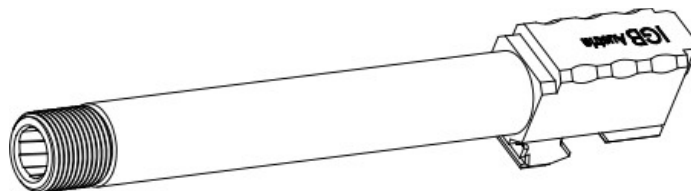

More threadings on request / Mehr Gewinde auf Anfrage

Add Custom Surface Oberflächenoptionen	Price / Preis
PVD (Gold, Silver, Tan, Bronze, ...)	Base + A05
Sandblast / Sandgestrahlt	Base + A04
Twisted Fluted / Spiralgeflutet	Base + A02
Straight Fluted / Geradegeflutet	Base + A02

PVD

SB

IGB BARRELS FOR GLOCK

Glock 29

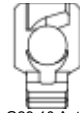

G29 10 Auto

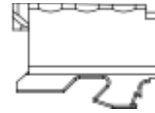

IGB Austria

Glock 29 Standard Length (96 MM)

Order No. Artikelnr.	From Von	Inner Profile Innenprofil	To Zu	Length Länge	Price Preis
29A-H010-S096	10 Auto	Hexagonal	10Auto	96 MM	H
29A-H040-S096	10 Auto	Hexagonal	40 S&W	96 MM	H
29A-P357-S096	10 Auto	Polygonal	357 Sig	96 MM	H
29A-H357-S096	10 Auto	Hexagonal	357 Sig	96 MM	H
29A-P925-S096	10 Auto	Polygonal	9x25 Dillon	96 MM	H
29A-H925-S096	10 Auto	Hexagonal	9x25 Dillon	96 MM	H

Glock 29 L=153 MM (6")

Order No. Artikelnr.	From Von	Inner Profile Innenprofil	To Zu	Length Länge	Price Preis
29A-H010-153	10 Auto	Hexagonal	10Auto	153 MM	I
29A-H040-153	10 Auto	Hexagonal	40 S&W	153 MM	I
29A-P357-153	10 Auto	Polygonal	357 Sig	153 MM	I
29A-H357-153	10 Auto	Hexagonal	357 Sig	153 MM	I
29A-P925-153	10 Auto	Polygonal	9x25 Dillon	153 MM	I
29A-H925-153	10 Auto	Hexagonal	9x25 Dillon	153 MM	I

Glock 29 L=191 MM (7.5")

Order No. Artikelnr.	From Von	Inner Profile Innenprofil	To Zu	Length Länge	Price Preis
29A-H010-191	10 Auto	Hexagonal	10Auto	191 MM	J
29A-H040-191	10 Auto	Hexagonal	40 S&W	191 MM	J
29A-P357-191	10 Auto	Polygonal	357 Sig	191 MM	J
29A-H357-191	10 Auto	Hexagonal	357 Sig	191 MM	J
29A-P925-191	10 Auto	Polygonal	9x25 Dillon	191 MM	J
29A-H925-191	10 Auto	Hexagonal	9x25 Dillon	191 MM	J



IGB BARRELS FOR GLOCK

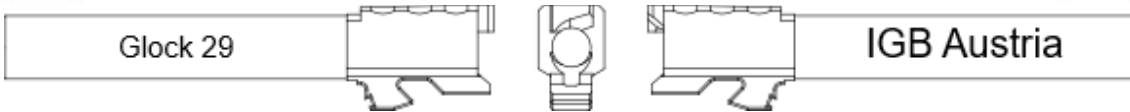

Glock 29 Threaded / Gewinde L=110 MM (4.3")

Caliber Kaliber	Profile Profil	Threading Gewinde	Order No. Artikelnr.	Threading Gewinde	Order No. Artikelnr.	Price Preis
10Auto	Hexa	M15x1	29A-H010-110-G07	M16x1	29A-H010-110-G09	H+A01
40 S&W	Hexa	M15x1	29A-H040-110-G07	M16x1	29A-H040-110-G09	H+A01
357 Sig	Poly	M15x1	29A-P357-110-G07	M16x1	29A-P357-110-G09	H+A01
357 Sig	Hexa	M15x1	29A-H357-110-G07	M16x1	29A-H357-110-G09	H+A01
9x25 DII	Poly	M15x1	29A-P925-110-G07	M16x1	29A-P925-110-G09	H+A01
9x25 DII	Hexa	M15x1	29A-H925-110-G07	M16x1	29A-H925-110-G09	H+A01

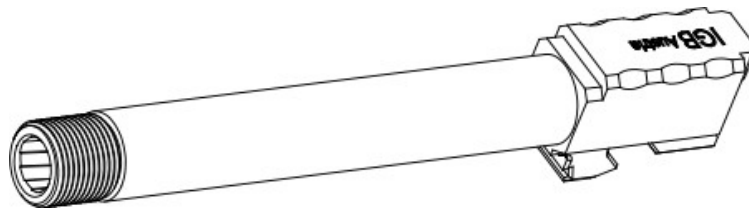

Glock 29 Threaded / Gewinde L=110 MM (4.3")

Caliber Kaliber	Profile Profil	Threading Gewinde	Order No. Artikelnr.	Threading Gewinde	Order No. Artikelnr.	Price Preis
10Auto	Hexa	M14x1	29A-H010-110-G05	M14x1L	29A-H010-110-G06	H+A01
40 S&W	Hexa	M14x1	29A-H040-110-G05	M14x1L	29A-H040-110-G06	H+A01
357 Sig	Poly	1/2x28	29A-P357-110-G01	13,5x1L	29A-P357-110-G04	H+A01
357 Sig	Hexa	1/2x28	29A-H357-110-G01	13,5x1L	29A-H357-110-G04	H+A01
9x25 DII	Poly	1/2x28	29A-P925-110-G01	13,5x1L	29A-P925-110-G04	H+A01
9x25 DII	Hexa	1/2x28	29A-H925-110-G01	13,5x1L	29A-H925-110-G04	H+A01

More threadings on request / Mehr Gewinde auf Anfrage

Accessories / Zubehör

	Price / Preis
Model Shark	A09
Model Shark Compact	A09
Steel Thread Protector	A08

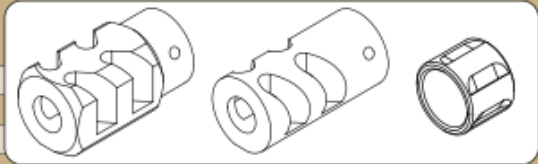

Add Custom Surface Oberflächenoptionen

	Price / Preis
PVD (Gold, Silver, Tan, Bronze, ...)	Base + A05
Sandblast / Sandgestrahlt	Base + A04
Twisted Fluted / Spiralgeflutet	Base + A02
Straight Fluted / Geradegeflutet	Base + A02

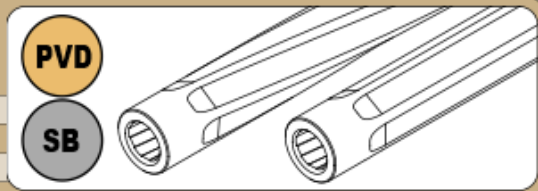

IGB BARRELS FOR GLOCK

Glock 30

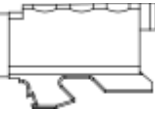

G30 .45 ACP

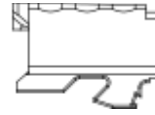

IGB Austria

Glock 30 Standard Length (96 MM)

Order No. Artikelnr.	From Von	Inner Profile Innenprofil	To Zu	Length Länge	Price Preis
30A-H045-S096	45 acp	Hexagonal	45 acp	96 MM	H
30A-H400-S096	45 acp	Hexagonal	400 CorBon	96 MM	H
30A-H010-S096	45 acp	Hexagonal	10Auto	96 MM	H
30A-H040-S096	45 acp	Hexagonal	40 S&W	96 MM	H
30A-P357-S096	45 acp	Polygonal	357 Sig	96 MM	H
30A-H357-S096	45 acp	Hexagonal	357 Sig	96 MM	H
30A-P925-S096	45 acp	Polygonal	9x25 Dillon	96 MM	H
30A-H925-S096	45 acp	Hexagonal	9x25 Dillon	96 MM	H

Glock 30 L=153 MM (6")

Order No. Artikelnr.	From Von	Inner Profile Innenprofil	To Zu	Length Länge	Price Preis
30A-H045-153	45 acp	Hexagonal	45 acp	153 MM	I
30A-H400-153	45 acp	Hexagonal	400 CorBon	153 MM	I
30A-H010-153	45 acp	Hexagonal	10Auto	153 MM	I
30A-H040-153	45 acp	Hexagonal	40 S&W	153 MM	I
30A-P357-153	45 acp	Polygonal	357 Sig	153 MM	I
30A-H357-153	45 acp	Hexagonal	357 Sig	153 MM	I
30A-P925-153	45 acp	Polygonal	9x25 Dillon	153 MM	I
30A-H925-153	45 acp	Hexagonal	9x25 Dillon	153 MM	I

Glock 30 L=191 MM (7.5")

Order No. Artikelnr.	From Von	Inner Profile Innenprofil	To Zu	Length Länge	Price Preis
30A-H045-191	45 acp	Hexagonal	45 acp	191 MM	J
30A-H400-191	45 acp	Hexagonal	400 CorBon	191 MM	J
30A-H010-191	45 acp	Hexagonal	10Auto	191 MM	J
30A-H040-191	45 acp	Hexagonal	40 S&W	191 MM	J
30A-P357-191	45 acp	Polygonal	357 Sig	191 MM	J
30A-H357-191	45 acp	Hexagonal	357 Sig	191 MM	J
30A-P925-191	45 acp	Polygonal	9x25 Dillon	191 MM	J
30A-H925-191	45 acp	Hexagonal	9x25 Dillon	191 MM	J

IGB BARRELS FOR GLOCK



Caliberchange Kaliberwechsel

**Magazine directly from us!
Magazin gleich bei uns mitbestellen!**

Changing from bigger to smaller cartridge bottom will require you to get a smaller Magazine!
Example; .45 to .357 Sig = Magazine needed / .45 to 400 CorBon = No Magazine needed

Wechsel von bestimmten Patronenbodendurchmessern benötigt ein Magazin!
Beispiel; .45 zu .357 Sig = Magazin benötigt / .45 zu 400 CorBon = Kein Magazin benötigt

Glock 30 Threaded / Gewinde L=132 MM (5.2")

Caliber Kaliber	Profile Profil	Threading Gewinde	Order No. Artikelnr.	Threading Gewinde	Order No. Artikelnr.	Price Preis
45 acp	Hexa	M15x1	30A-H045-132-G07	M16x1	30A-H045-132-G09	H+A01
400 CrBn	Hexa	M15x1	30A-H400-132-G07	M16x1	30A-H400-132-G09	H+A01
10 Auto	Hexa	M15x1	30A-H010-132-G07	M16x1	30A-H010-132-G09	H+A01
40 S&W	Hexa	M15x1	30A-H040-132-G07	M16x1	30A-H040-132-G09	H+A01
357 Sig	Poly	M15x1	30A-P357-132-G07	M16x1	30A-P357-132-G09	H+A01
357 Sig	Hexa	M15x1	30A-H357-132-G07	M16x1	30A-H357-132-G09	H+A01
9x25 Dll	Poly	M15x1	30A-P925-132-G07	M16x1	30A-P925-132-G09	H+A01
9x25 Dll	Hexa	M15x1	30A-H925-132-G07	M16x1	30A-H925-132-G09	H+A01
Caliber Kaliber	Profile Profil	Threading Gewinde	Order No. Artikelnr.	Threading Gewinde	Order No. Artikelnr.	Price Preis
45 acp	Hexa	M14x1	30A-H045-132-G05	M14x1L	30A-H045-132-G06	H+A01
400 CrBn	Hexa	M14x1	30A-H400-132-G05	M14x1L	30A-H400-132-G06	H+A01
10 Auto	Hexa	M14x1	30A-H010-132-G05	M14x1L	30A-H010-132-G06	H+A01
40 S&W	Hexa	M14x1	30A-H040-132-G05	M14x1L	30A-H040-132-G06	H+A01
357 Sig	Poly	1/2x28	30A-P357-132-G01	13,5x1L	30A-P357-132-G04	H+A01
357 Sig	Hexa	1/2x28	30A-H357-132-G01	13,5x1L	30A-H357-132-G04	H+A01
9x25 Dll	Poly	1/2x28	30A-P925-132-G01	13,5x1L	30A-P925-132-G04	H+A01
9x25 Dll	Hexa	1/2x28	30A-H925-132-G01	13,5x1L	30A-H925-132-G04	H+A01

More threadings on request / Mehr Gewinde auf Anfrage

Add Custom Surface Oberflächenoptionen	Price / Preis
PVD (Gold, Silver, Tan, Bronze, ...)	Base + A05
Sandblast / Sandgestrahlt	Base +A04
Twisted Fluted / Spiralgefütet	Base +A02
Straight Fluted / Geradegefütet	Base +A02

PVD

SB

IGB BARRELS IDEAS

Make it YOUR Gun with the IGB Variety
 Machen Sie es zu IHRER Pistole mit den IGB Variationen.

Add Custom Surface Oberflächenoptionen

	Price / Preis
PVD (Gold, Silver, Tan, Bronze, ...)	Base + A05
Sandblast / Sandgestrahlt	Base +A04
Twisted Fluted / Spiralgeflutet	Base +A02
Straight Fluted / Geradegeflutet	Base +A02

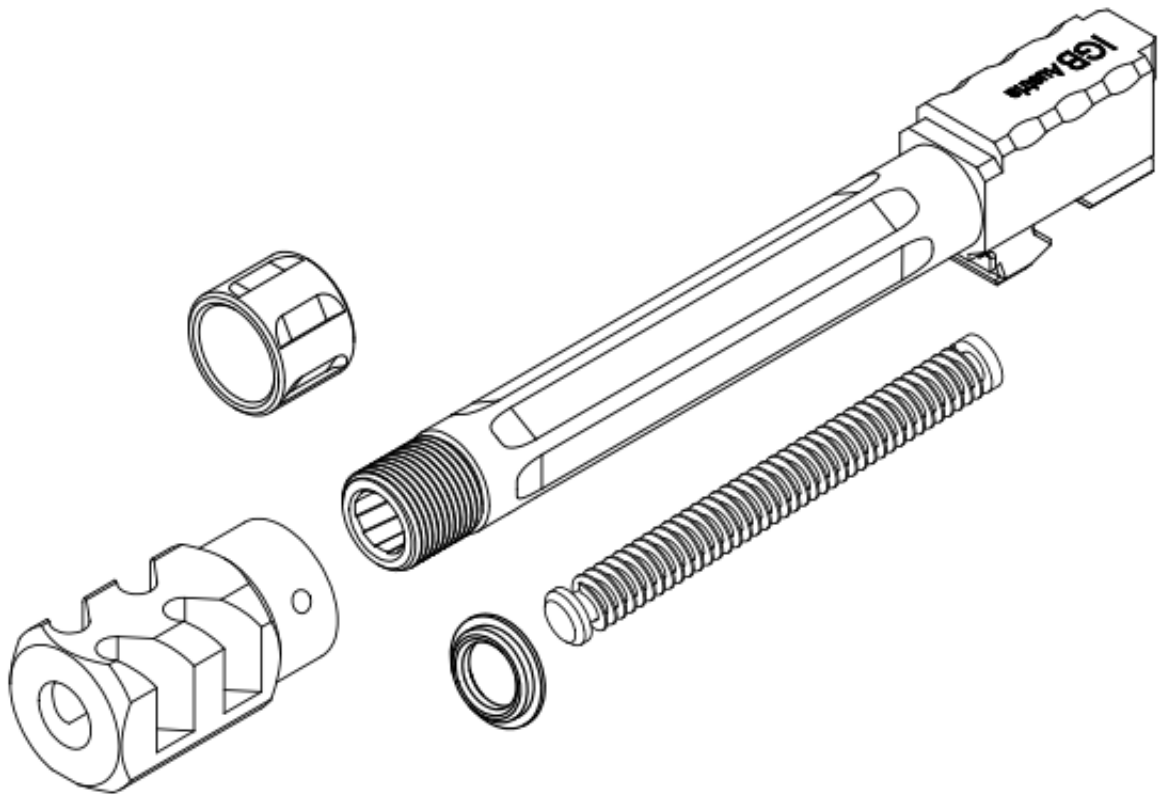
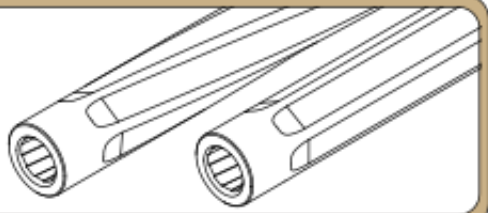

Polygonal vs Hexagonal

Polygonal is very smooth inside and therefore very gastight for high velocity.
 Polygonal ist formbedingt sehr Gasdicht für hohe Geschwindigkeiten.

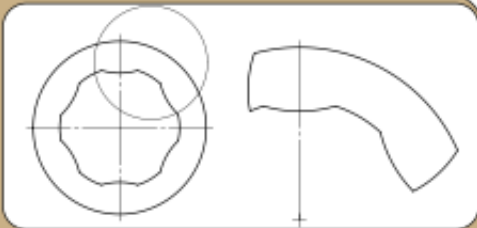
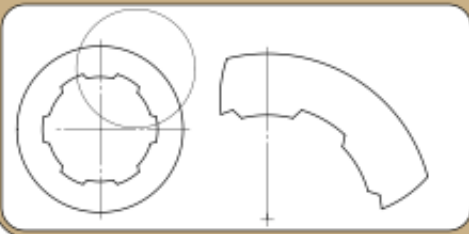

Hexagonal is the more classic approach and also well suited for pure led.
 Hexagonal ist der klassischere Ansatz und gut geeignet für reine Bleigeschöße.

IGB BARRELS FOR GLOCK

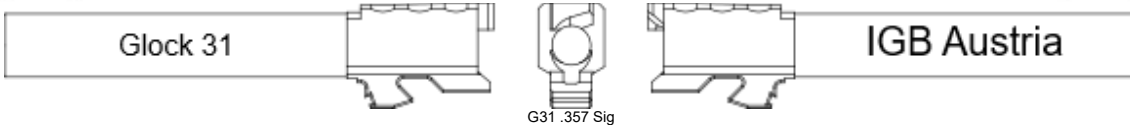

Glock 31 Standard Length (114 MM)

Order No. Artikelnr.	From Von	Inner Profile Innenprofil	To Zu	Length Länge	Price Preis
22A-H040-S114	357 Sig	Hexagonal	40 S&W	114 MM	H
22A-H357-S114	357 Sig	Hexagonal	357 Sig	114 MM	H
22A-P357-S114	357 Sig	Polygonal	357 Sig	114 MM	H
22A-H919-S114	357 Sig	Hexagonal	9x19	114 MM	H
22A-P919-S114	357 Sig	Polygonal	9x19	114 MM	H
22A-H765-S114	357 Sig	Hexagonal	7,65 Para	114 MM	H

Glock 31 L=153 MM (6")

Order No. Artikelnr.	From Von	Inner Profile Innenprofil	To Zu	Length Länge	Price Preis
22A-H040-153	357 Sig	Hexagonal	40 S&W	153 MM	I
22A-H357-153	357 Sig	Hexagonal	357 Sig	153 MM	I
22A-P357-153	357 Sig	Polygonal	357 Sig	153 MM	I
22A-H919-153	357 Sig	Hexagonal	9x19	153 MM	I
22A-P919-153	357 Sig	Polygonal	9x19	153 MM	I
22A-H765-153	357 Sig	Hexagonal	7,65 Para	153 MM	I

Glock 31 L=191 MM (7.5")

Order No. Artikelnr.	From Von	Inner Profile Innenprofil	To Zu	Length Länge	Price Preis
22A-H040-191	357 Sig	Hexagonal	40 S&W	191 MM	J
22A-H357-191	357 Sig	Hexagonal	357 Sig	191 MM	J
22A-P357-191	357 Sig	Polygonal	357 Sig	191 MM	J
22A-H919-191	357 Sig	Hexagonal	9x19	191 MM	J
22A-P919-191	357 Sig	Polygonal	9x19	191 MM	J
22A-H765-191	357 Sig	Hexagonal	7,65 Para	191 MM	J

Caliberchange Kaliberwechsel

**Magazine directly from us!
Magazin gleich bei uns mitbestellen!**

Changing from bigger to smaller cartridge bottom will require you to get a smaller Magazine!
Example; **.357 Sig to 9x19 = Magazine needed / .40 to .357 Sig = No Magazine needed**

Wechsel von bestimmten Patronenbodendurchmessern benötigt ein Magazin!
Beispiel; **.357 Sig zu 9x19 = Magazin benötigt / .40 zu .357.Sig = Kein Magazin benötigt**

IGB BARRELS FOR GLOCK

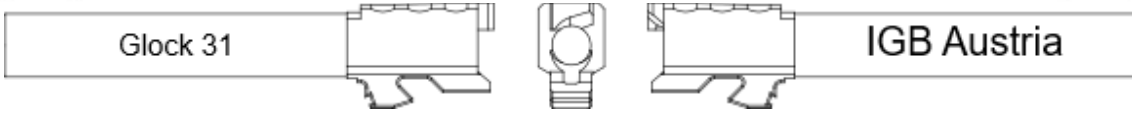

Glock 31 Threaded / Gewinde L=128 MM (5")

Caliber Kaliber	Profile Profil	Threading Gewinde	Order No. Artikelnr.	Threading Gewinde	Order No. Artikelnr.	Price Preis
40 S&W	Hexa	M13x1	22A-H040-128-G02	M14x1	22A-H040-128-G05	H+A01
357 Sig	Hexa	M13x1	22A-H357-128-G02	M14x1	22A-H357-128-G05	H+A01
357 Sig	Poly	M13x1	22A-P357-128-G02	M14x1	22A-P357-128-G05	H+A01
9x19	Hexa	M13x1	22A-P919-128-G02	M14x1	22A-P919-128-G05	H+A01
9x19	Poly	M13x1	22A-H919-128-G02	M14x1	22A-H919-128-G05	H+A01
7,65 Para	Hexa	M13x1	22A-H765-128-G02	M14x1	22A-H765-128-G05	H+A01

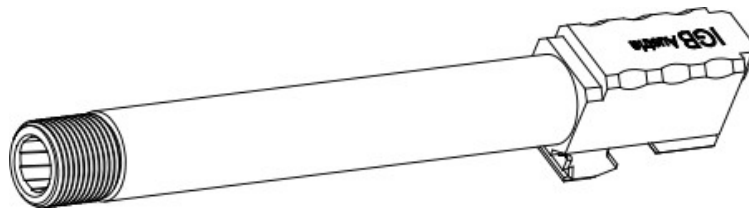

Glock 31 Threaded / Gewinde L=128 MM (5")

Caliber Kaliber	Profile Profil	Threading Gewinde	Order No. Artikelnr.	Threading Gewinde	Order No. Artikelnr.	Price Preis
40 S&W	Hexa	1/2x28	22A-H040-128-G01	13,5x1L	22A-H040-128-G04	H+A01
357 Sig	Hexa	1/2x28	22A-H357-128-G01	13,5x1L	22A-H357-128-G04	H+A01
357 Sig	Poly	1/2x28	22A-P357-128-G01	13,5x1L	22A-P357-128-G04	H+A01
9x19	Hexa	1/2x28	22A-P919-128-G01	13,5x1L	22A-P919-128-G04	H+A01
9x19	Poly	1/2x28	22A-H919-128-G01	13,5x1L	22A-H919-128-G04	H+A01
7,65 Para	Hexa	1/2x28	22A-H765-128-G01	13,5x1L	22A-H765-128-G04	H+A01

More threadings on request / Mehr Gewinde auf Anfrage

Accessories / Zubehör

	Price / Preis
Model Shark	A09
Model Shark Compact	A09
Steel Thread Protector	A08

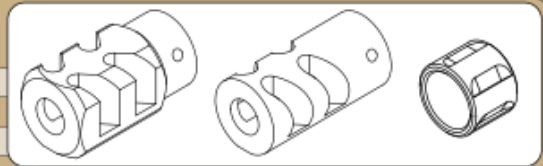

**Add Custom Surface
Oberflächenoptionen**

	Price / Preis
PVD (Gold, Silver, Tan, Bronze, ...)	Base + A05
Sandblast / Sandgestrahlt	Base + A04
Twisted Fluted / Spiralgefütet	Base + A02
Straight Fluted / Geradegefütet	Base + A02

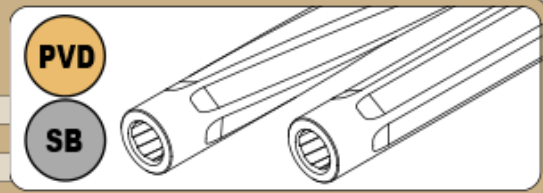

IGB BARRELS FOR GLOCK

Glock 31

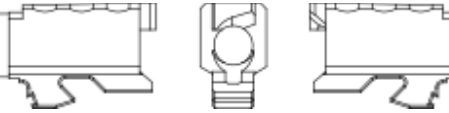

IGB Austria

Glock 31 L=255 MM (10") with 1/2x28 UNEF

Order No. Artikelnr.	From Von	Inner Profile Innenprofil	To Zu	Length Länge	Price Preis
22A-H040-255	357 Sig	Hexagonal	40 S&W	255 MM	K
22A-H357-255	357 Sig	Hexagonal	357 Sig	255 MM	K
22A-P357-255	357 Sig	Polygonal	357 Sig	255 MM	K
22A-H919-255	357 Sig	Hexagonal	9x19	255 MM	K
22A-P919-255	357 Sig	Polygonal	9x19	255 MM	K

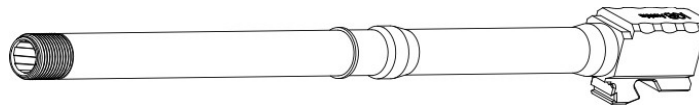

Accessories 10" Zubehör 255 MM

	Price / Preis
Muzzledevice / Schwingungsdämpfer	A09
Ported Shroud 10" / Laufmantel Geportet 255 MM	A12
Steel Thread Protector / Gewindeschutz	A08



Glock 31 L=410 MM (16") with 1/2x28 UNEF

Order No. Artikelnr.	From Von	Inner Profile Innenprofil	To Zu	Length Länge	Price Preis
22A-H040-410	357 Sig	Hexagonal	40 S&W	410 MM	L
22A-H357-410	357 Sig	Hexagonal	357 Sig	410 MM	L
22A-P357-410	357 Sig	Polygonal	357 Sig	410 MM	L
22A-H919-410	357 Sig	Hexagonal	9x19	410 MM	L
22A-P919-410	357 Sig	Polygonal	9x19	410 MM	L

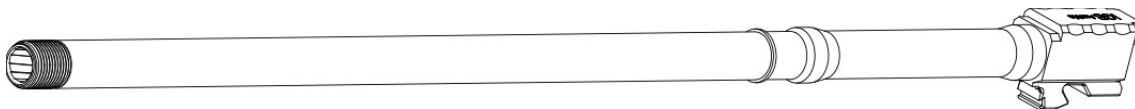

Accessories 16" Zubehör 410 MM

	Price / Preis
Muzzledevice / Schwingungsdämpfer	A09
Ported Shroud 16" / Laufmantel Geportet 410 MM	A13
Steel Thread Protector / Gewindeschutz	A08



IGB BARRELS FOR GLOCK

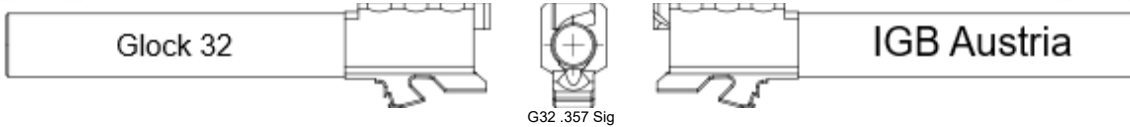

Glock 32 Standard Length (102 MM)

Order No. Artikelnr.	From Von	Inner Profile Innenprofil	To Zu	Length Länge	Price Preis
23A-H040-S102	357 Sig	Hexagonal	40 S&W	102 MM	H
23A-H357-S102	357 Sig	Hexagonal	357 Sig	102 MM	H
23A-P357-S102	357 Sig	Polygonal	357 Sig	102 MM	H
23A-H919-S102	357 Sig	Hexagonal	9x19	102 MM	H
23A-P919-S102	357 Sig	Polygonal	9x19	102 MM	H
23A-H765-S102	357 Sig	Hexagonal	7,65 Para	102 MM	H

Glock 32 L=153 MM (6")

Order No. Artikelnr.	From Von	Inner Profile Innenprofil	To Zu	Length Länge	Price Preis
23A-H040-153	357 Sig	Hexagonal	40 S&W	153 MM	I
23A-H357-153	357 Sig	Hexagonal	357 Sig	153 MM	I
23A-P357-153	357 Sig	Polygonal	357 Sig	153 MM	I
23A-H919-153	357 Sig	Hexagonal	9x19	153 MM	I
23A-P919-153	357 Sig	Polygonal	9x19	153 MM	I
23A-H765-153	357 Sig	Hexagonal	7,65 Para	153 MM	I

Glock 32 L=191 MM (7.5")

Order No. Artikelnr.	From Von	Inner Profile Innenprofil	To Zu	Length Länge	Price Preis
23A-H040-191	357 Sig	Hexagonal	40 S&W	191 MM	J
23A-H357-191	357 Sig	Hexagonal	357 Sig	191 MM	J
23A-P357-191	357 Sig	Polygonal	357 Sig	191 MM	J
23A-H919-191	357 Sig	Hexagonal	9x19	191 MM	J
23A-P919-191	357 Sig	Polygonal	9x19	191 MM	J
23A-H765-191	357 Sig	Hexagonal	7,65 Para	191 MM	J

**Caliberchange
Kaliberwechsel**
**Magazine directly from us!
Magazin gleich bei uns mitbestellen!**

Changing from bigger to smaller cartridge bottom will require you to get a smaller Magazine!
Example; .357 Sig to 9x19 = Magazine needed / .40 to .357 Sig = No Magazine needed

Wechsel von bestimmten Patronenbodendurchmessern benötigt ein Magazin!
Beispiel; .357 Sig zu 9x19 = Magazin benötigt / .40 zu .357.Sig = Kein Magazin benötigt

IGB BARRELS FOR GLOCK



Glock 32 Threaded / Gewinde L=116 MM (4.6")

Caliber Kaliber	Profile Profil	Threading Gewinde	Order No. Artikelnr.	Threading Gewinde	Order No. Artikelnr.	Price Preis
40 S&W	Hexa	M13x1	23A-H040-116-G02	M14x1	23A-H040-116-G05	H+A01
357 Sig	Hexa	M13x1	23A-H357-116-G02	M14x1	23A-H357-116-G05	H+A01
357 Sig	Poly	M13x1	23A-P357-116-G02	M14x1	23A-P357-116-G05	H+A01
9x19	Hexa	M13x1	23A-H919-116-G02	M14x1	23A-H919-116-G05	H+A01
9x19	Poly	M13x1	23A-P919-116-G02	M14x1	23A-P919-116-G05	H+A01
7,65 Para	Hexa	M13x1	23A-H765-116-G02	M14x1	23A-H765-116-G05	H+A01

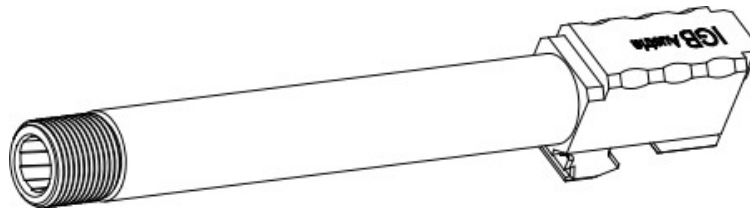

Glock 32 Threaded / Gewinde L=116 MM (4.6")

Caliber Kaliber	Profile Profil	Threading Gewinde	Order No. Artikelnr.	Threading Gewinde	Order No. Artikelnr.	Price Preis
40 S&W	Hexa	1/2x28	23A-H040-116-G01	13,5x1L	23A-H040-116-G04	H+A01
357 Sig	Hexa	1/2x28	23A-H357-116-G01	13,5x1L	23A-H357-116-G04	H+A01
357 Sig	Poly	1/2x28	23A-P357-116-G01	13,5x1L	23A-P357-116-G04	H+A01
9x19	Hexa	1/2x28	23A-H919-116-G01	13,5x1L	23A-H919-116-G04	H+A01
9x19	Poly	1/2x28	23A-P919-116-G01	13,5x1L	23A-P919-116-G04	H+A01
7,65 Para	Hexa	1/2x28	23A-H765-116-G01	13,5x1L	23A-H765-116-G04	H+A01

More threadings on request / Mehr Gewinde auf Anfrage

Accessories / Zubehör

	Price / Preis
Model Shark	A09
Model Shark Compact	A09
Steel Thread Protector	A08

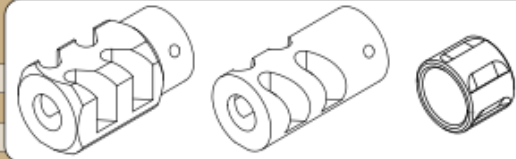

Add Custom Surface Oberflächenoptionen

	Price / Preis
PVD (Gold, Silver, Tan, Bronze, ...)	Base + A05
Sandblast / Sandgestrahlt	Base + A04
Twisted Fluted / Spiralgeflutet	Base + A02
Straight Fluted / Geradegeflutet	Base + A02

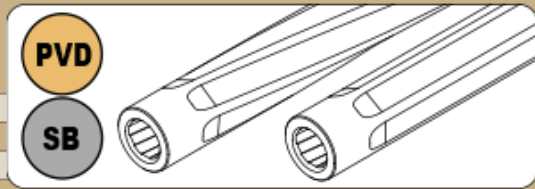

IGB BARRELS FOR GLOCK

Glock 32

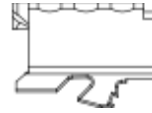
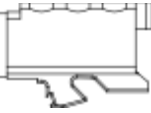

IGB Austria

Glock 32 L=255 MM (10") with 1/2x28 UNEF

Order No. Artikelnr.	From Von	Inner Profile Innenprofil	To Zu	Length Länge	Price Preis
23A-H040-255	357 Sig	Hexagonal	40 S&W	255 MM	K
23A-H357-255	357 Sig	Hexagonal	357 Sig	255 MM	K
23A-P357-255	357 Sig	Polygonal	357 Sig	255 MM	K
23A-H919-255	357 Sig	Hexagonal	9x19	255 MM	K
23A-P919-255	357 Sig	Polygonal	9x19	255 MM	K

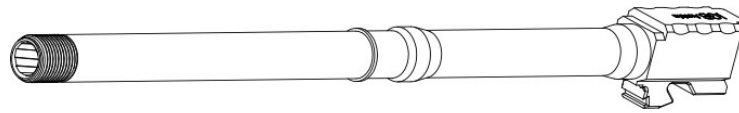

**Accessories 10"
Zubehör 255 MM**

	Price / Preis
Muzzledevice / Schwingungsdämpfer	A09
Ported Shroud 10" / Laufmantel Geportet 255 MM	A12
Steel Thread Protector / Gewindeschutz	A08

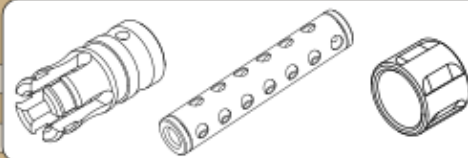

Glock 32 L=410 MM (16") with 1/2x28 UNEF

Order No. Artikelnr.	From Von	Inner Profile Innenprofil	To Zu	Length Länge	Price Preis
23A-H040-410	357 Sig	Hexagonal	40 S&W	410 MM	L
23A-H357-410	357 Sig	Hexagonal	357 Sig	410 MM	L
23A-P357-410	357 Sig	Polygonal	357 Sig	410 MM	L
23A-H919-410	357 Sig	Hexagonal	9x19	410 MM	L
23A-P919-410	357 Sig	Polygonal	9x19	410 MM	L

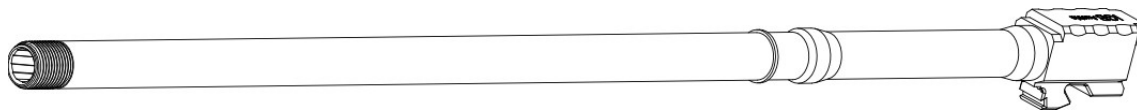

**Accessories 16"
Zubehör 410 MM**

	Price / Preis
Muzzledevice / Schwingungsdämpfer	A09
Ported Shroud 16" / Laufmantel Geportet 410 MM	A13
Steel Thread Protector / Gewindeschutz	A08

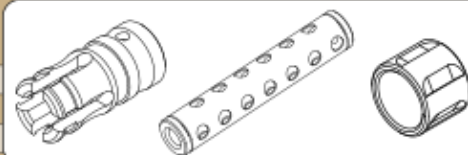

IGB BARRELS FOR GLOCK

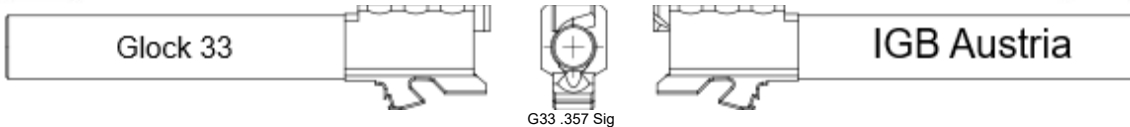

Glock 33 Standard Length (87 MM)

Order No. Artikelnr.	From Von	Inner Profile Innenprofil	To Zu	Length Länge	Price Preis
23A-H040-S087	357 Sig	Hexagonal	40 S&W	87 MM	H
23A-H357-S087	357 Sig	Hexagonal	357 Sig	87 MM	H
23A-P357-S087	357 Sig	Polygonal	357 Sig	87 MM	H
23A-H919-S087	357 Sig	Hexagonal	9x19	87 MM	H
23A-P919-S087	357 Sig	Polygonal	9x19	87 MM	H
23A-H765-S087	357 Sig	Hexagonal	7,65 Para	87 MM	H

Glock 33 L=153 MM (6")

Order No. Artikelnr.	From Von	Inner Profile Innenprofil	To Zu	Length Länge	Price Preis
23A-H040-153	357 Sig	Hexagonal	40 S&W	153 MM	I
23A-H357-153	357 Sig	Hexagonal	357 Sig	153 MM	I
23A-P357-153	357 Sig	Polygonal	357 Sig	153 MM	I
23A-H919-153	357 Sig	Hexagonal	9x19	153 MM	I
23A-P919-153	357 Sig	Polygonal	9x19	153 MM	I
23A-H765-153	357 Sig	Hexagonal	7,65 Para	153 MM	I

Glock 33 L=191 MM (7.5")

Order No. Artikelnr.	From Von	Inner Profile Innenprofil	To Zu	Length Länge	Price Preis
23A-H040-191	357 Sig	Hexagonal	40 S&W	191 MM	J
23A-H357-191	357 Sig	Hexagonal	357 Sig	191 MM	J
23A-P357-191	357 Sig	Polygonal	357 Sig	191 MM	J
23A-H919-191	357 Sig	Hexagonal	9x19	191 MM	J
23A-P919-191	357 Sig	Polygonal	9x19	191 MM	J
23A-H765-191	357 Sig	Hexagonal	7,65 Para	191 MM	J

Caliberchange Kaliberwechsel

**Magazine directly from us!
Magazin gleich bei uns mitbestellen!**

Changing from bigger to smaller cartridge bottom will require you to get a smaller Magazine!
Example; **.357 Sig to 9x19 = Magazine needed / .40 to .357 Sig = No Magazine needed**

Wechsel von bestimmten Patronenbodendurchmessern benötigt ein Magazin!
Beispiel; **.357 Sig zu 9x19 = Magazin benötigt / .40 zu .357.Sig = Kein Magazin benötigt**

IGB BARRELS FOR GLOCK

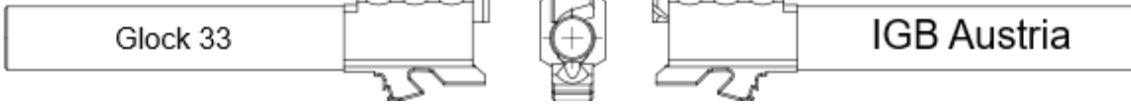

Glock 33 Threaded / Gewinde L=101 MM (4")

Caliber Kaliber	Profile Profil	Threading Gewinde	Order No. Artikelnr.	Threading Gewinde	Order No. Artikelnr.	Price Preis
40 S&W	Hexa	M13x1	23A-H040-101-G02	M14x1	23A-H040-101-G05	H+A01
357 Sig	Hexa	M13x1	23A-H357-101-G02	M14x1	23A-H357-101-G05	H+A01
357 Sig	Poly	M13x1	23A-P357-101-G02	M14x1	23A-P357-101-G05	H+A01
9x19	Hexa	M13x1	23A-H919-101-G02	M14x1	23A-H919-101-G05	H+A01
9x19	Poly	M13x1	23A-P919-101-G02	M14x1	23A-P919-101-G05	H+A01
7,65 Para	Hexa	M13x1	23A-H765-101-G02	M14x1	23A-H765-101-G05	H+A01

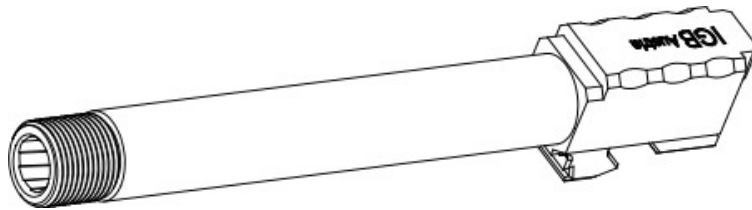

Glock 33 Threaded / Gewinde L=101 MM (4")

Caliber Kaliber	Profile Profil	Threading Gewinde	Order No. Artikelnr.	Threading Gewinde	Order No. Artikelnr.	Price Preis
40 S&W	Hexa	1/2x28	23A-H040-101-G01	13,5x1L	23A-H040-101-G04	H+A01
357 Sig	Hexa	1/2x28	23A-H357-101-G01	13,5x1L	23A-H357-101-G04	H+A01
357 Sig	Poly	1/2x28	23A-P357-101-G01	13,5x1L	23A-P357-101-G04	H+A01
9x19	Hexa	1/2x28	23A-H919-101-G01	13,5x1L	23A-H919-101-G04	H+A01
9x19	Poly	1/2x28	23A-P919-101-G01	13,5x1L	23A-P919-101-G04	H+A01
7,65 Para	Hexa	1/2x28	23A-H765-101-G01	13,5x1L	23A-H765-101-G04	H+A01

More threadings on request / Mehr Gewinde auf Anfrage

Accessories / Zubehör

	Price / Preis
Model Shark	A09
Model Shark Compact	A09
Steel Thread Protector	A08

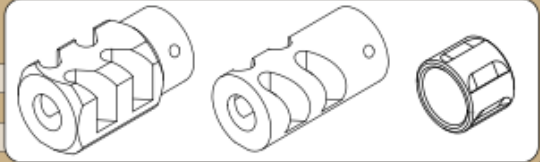

**Add Custom Surface
Oberflächenoptionen**

	Price / Preis
PVD (Gold, Silver, Tan, Bronze, ...)	Base + A05
Sandblast / Sandgestrahlt	Base + A04
Twisted Fluted / Spiralgefütet	Base + A02
Straight Fluted / Geradegefütet	Base + A02

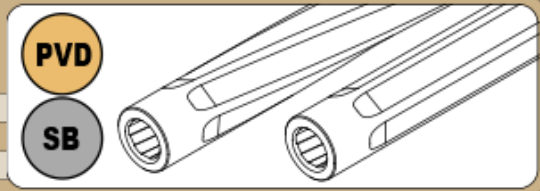

IGB BARRELS IDEAS

Make it YOUR Gun with the IGB Variety
 Machen Sie es zu IHRER Pistole mit den IGB Variationen.

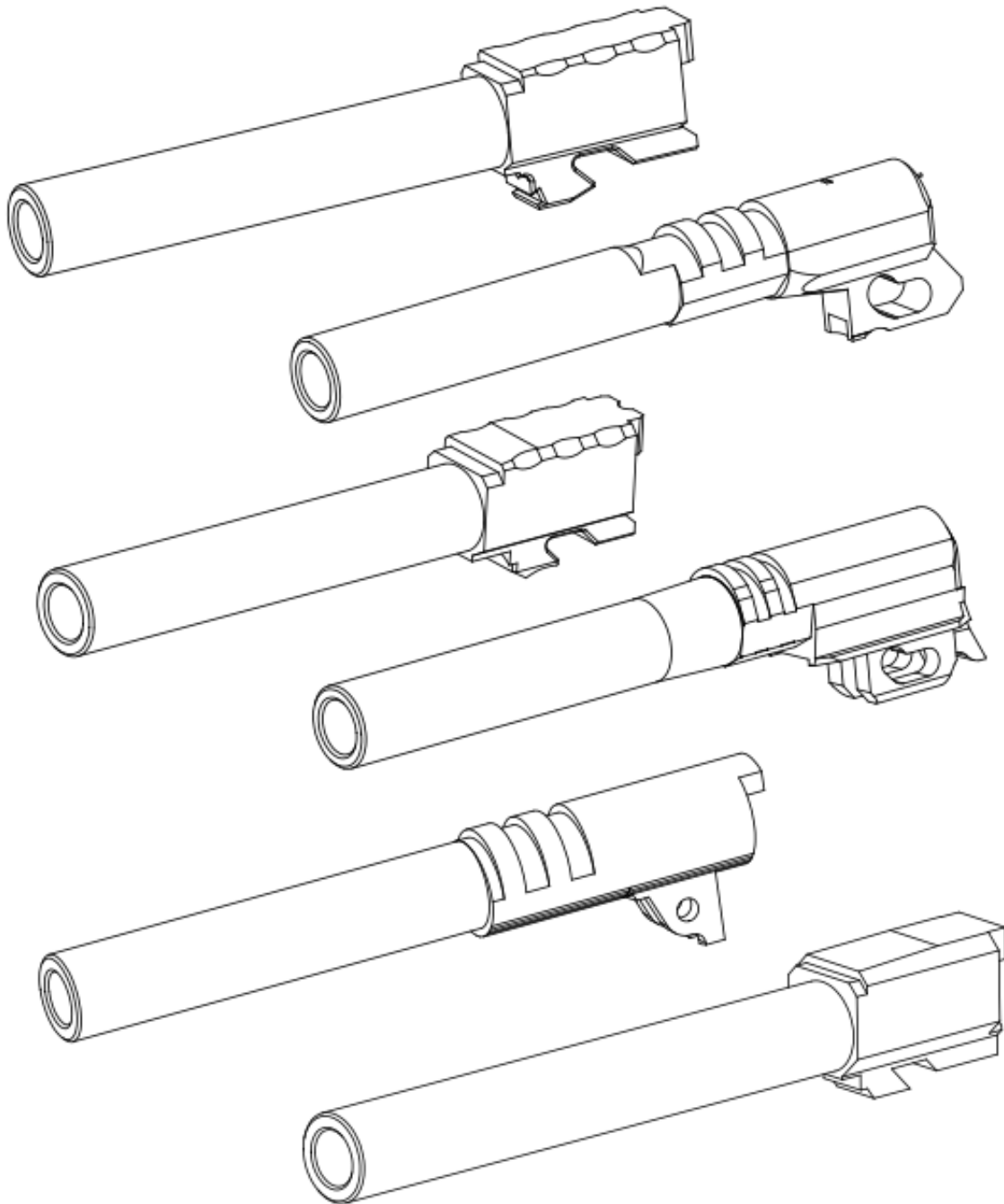

Add Custom Surface Oberflächenoptionen

PVD (Gold, Silver, Tan, Bronze, ...)	Price / Preis Base + A05
Sandblast / Sandgestrahlt	Base +A04
Twisted Fluted / Spiralgeflutet	Base +A02
Straight Fluted / Geradegeflutet	Base +A02

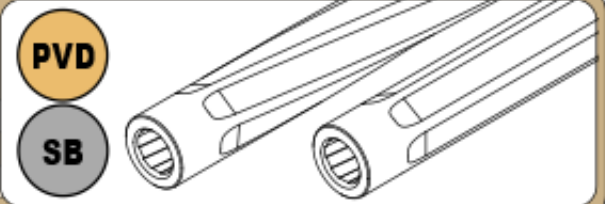

IGB BARRELS FOR GLOCK

Glock 34 Gen.2 - Gen.4



G34 9x19 Gen.2 - Gen.4

IGB Austria

Glock 34 Gen.2 – Gen.4 Standard Length (135 MM)

Order No. Artikelnr.	From Von	Inner Profile Innenprofil	To Zu	Length Länge	Price Preis
34A-P919-S135	9x19	Polygonal	9x19	135 MM	H
34A-H919-S135	9x19	Hexagonal	9x19	135 MM	H
34A-P921-S135	9x19	Polygonal	9x21	135 MM	H
34A-H919-S135	9x19	Hexagonal	9x21	135 MM	H
34A-H765-S135	9x19	Hexagonal	7,65 Para*	135 MM	H

*9mm Magazine can be used / 9mm Magazin kann verwendet werden

Glock 34 Gen.2 – Gen.4 L=153 MM (6")

Order No. Artikelnr.	From Von	Inner Profile Innenprofil	To Zu	Length Länge	Price Preis
17A-P919-153	9x19	Polygonal	9x19	153 MM	I
17A-H919-153	9x19	Hexagonal	9x19	153 MM	I
17A-P921-153	9x19	Polygonal	9x21	153 MM	I
17A-H919-153	9x19	Hexagonal	9x21	153 MM	I
17A-H765-153	9x19	Hexagonal	7,65 Para*	153 MM	I

*9mm Magazine can be used / 9mm Magazin kann verwendet werden

Glock 34 Gen.2 – Gen.4 L=191 MM (7.5")

Order No. Artikelnr.	From Von	Inner Profile Innenprofil	To Zu	Length Länge	Price Preis
17A-P919-191	9x19	Polygonal	9x19	191 MM	J
17A-H919-191	9x19	Hexagonal	9x19	191 MM	J
17A-P921-191	9x19	Polygonal	9x21	191 MM	J
17A-H919-191	9x19	Hexagonal	9x21	191 MM	J

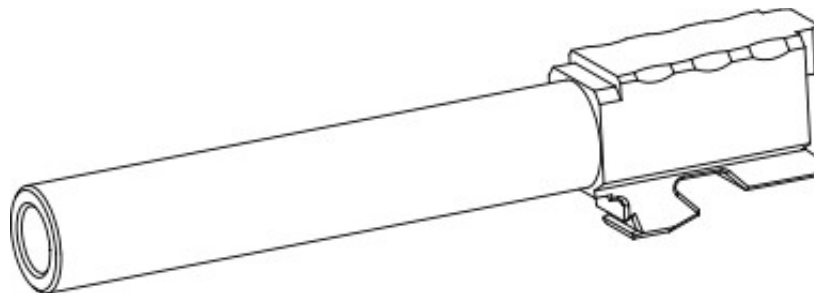

IGB BARRELS FOR GLOCK

Glock 34 Gen.2 - Gen.4

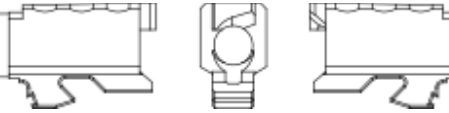

IGB Austria

Glock 34 Gen.2 – Gen.4 Threaded / Gewinde L=149 MM (5.9“)

Caliber Kaliber	Profile Profil	Threading Gewinde	Order No. Artikelnr.	Threading Gewinde	Order No. Artikelnr.	Price Preis
9x19	Hexa	M13x1	34A-P919-149-G02	M14x1	34A-P919-149-G05	H+A01
9x19	Poly	M13x1	34A-H919-149-G02	M14x1	34A-H919-149-G05	H+A01
9x21	Hexa	M13x1	34AP921-149-G02	M14x1	34A-P921-149-G05	H+A01
9x21	Poly	M13x1	34A-H921-149-G02	M14x1	34A-H921-149-G05	H+A01
7,65 Para	Hexa	M13x1	34A-H765-149-G02	M14x1	34A-H765-149-G05	H+A01

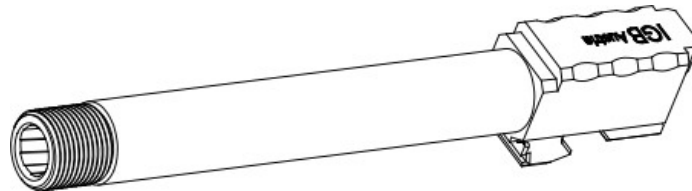

Glock 34 Gen.2 – Gen.4 Threaded / Gewinde L=149 MM (5.9“)

Caliber Kaliber	Profile Profil	Threading Gewinde	Order No. Artikelnr.	Threading Gewinde	Order No. Artikelnr.	Price Preis
9x19	Hexa	1/2x28	34A-P919-149-G01	13,5x1L	34A-P919-149-G04	H+A01
9x19	Poly	1/2x28	34A-H919-149-G01	13,5x1L	34A-H919-149-G04	H+A01
9x21	Hexa	1/2x28	34AP921-149-G01	13,5x1L	34A-P921-149-G04	H+A01
9x21	Poly	1/2x28	34A-H921-149-G01	13,5x1L	34A-H921-149-G04	H+A01
7,65 Para	Hexa	1/2x28	34A-H765-149-G01	13,5x1L	34A-H765-149-G04	H+A01

More threadings on request / Mehr Gewinde auf Anfrage

Accessories / Zubehör

	Price / Preis
Model Shark	A09
Model Shark Compact	A09
Steel Thread Protector	A08

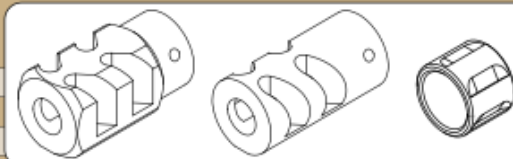

Add Custom Surface Oberflächenoptionen

	Price / Preis
PVD (Gold, Silver, Tan, Bronze, ...)	Base + A05
Sandblast / Sandgestrahlt	Base + A04
Twisted Fluted / Spiralgefütet	Base + A02
Straight Fluted / Geradegefütet	Base + A02

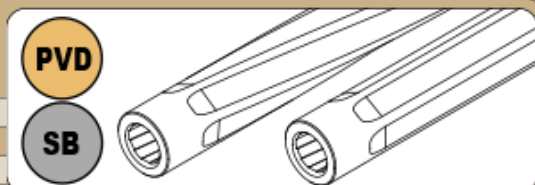

IGB BARRELS FOR GLOCK

Glock 34 Gen.2 - Gen.4

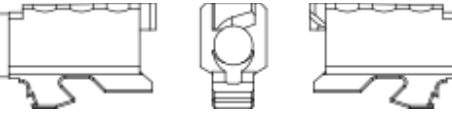

IGB Austria

Glock 34 Gen.2 – Gen.4 L=255 MM (10“) with 1/2x28 UNEF

Order No. Artikelnr.	From Von	Inner Profile Innenprofil	To Zu	Length Länge	Price Preis
34A-P919-255	9x19	Hexagonal	9x19	255 MM	K
34A-H919-255	9x19	Hexagonal	9x19	255 MM	K
34A-P921-255	9x19	Polygonal	9x21	255 MM	K
34A-H919-255	9x19	Hexagonal	9x21	255 MM	K

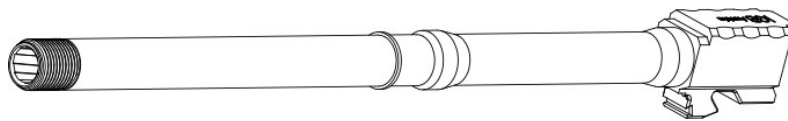

Accessories 10" Zubehör 255 MM

	Price / Preis
Muzzledevice / Schwingungsdämpfer	A09
Ported Shroud 10" / Laufmantel Geportet 255 MM	A12
Steel Thread Protector / Gewindeschutz	A08

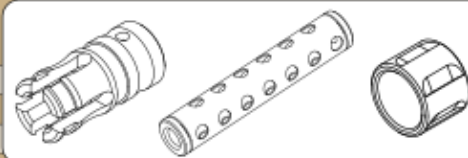

Glock 34 Gen.2 – Gen.4 L=410 MM (16“) with 1/2x28 UNEF

Order No. Artikelnr.	From Von	Inner Profile Innenprofil	To Zu	Length Länge	Price Preis
34A-P919-410	9x19	Hexagonal	9x19	410 MM	L
34A-H919-410	9x19	Hexagonal	9x19	410 MM	L
34A-P921-410	9x19	Polygonal	9x21	410 MM	L
34A-H919-410	9x19	Hexagonal	9x21	410 MM	L

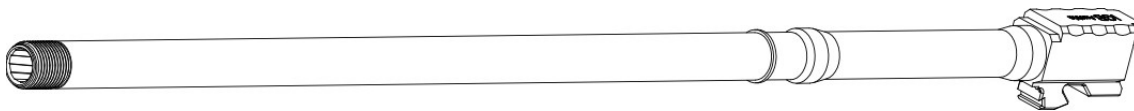

Accessories 16" Zubehör 410 MM

	Price / Preis
Muzzledevice / Schwingungsdämpfer	A09
Ported Shroud 16" / Laufmantel Geportet 410 MM	A13
Steel Thread Protector / Gewindeschutz	A08

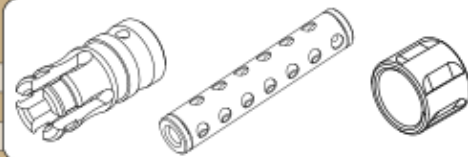

IGB BARRELS FOR GLOCK

Glock 34 Gen.5

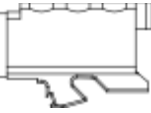

G34 9x19 Gen. 5

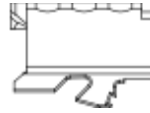

IGB Austria

Glock 34 Gen.2 – Gen.4 Standard Length (135 MM)

Order No. Artikelnr.	From Von	Inner Profile Innenprofil	To Zu	Length Länge	Price Preis
34B-P919-S135	9x19	Polygonal	9x19	135 MM	H
34B-H919-S135	9x19	Hexagonal	9x19	135 MM	H
34B-P921-S135	9x19	Polygonal	9x21	135 MM	H
34B-H919-S135	9x19	Hexagonal	9x21	135 MM	H
34B-H765-S135	9x19	Hexagonal	7,65 Para*	135 MM	H

*9mm Magazine can be used / 9mm Magazin kann verwendet werden

Glock 34 Gen.2 – Gen.4 L=153 MM (6“)

Order No. Artikelnr.	From Von	Inner Profile Innenprofil	To Zu	Length Länge	Price Preis
17B-P919-153	9x19	Polygonal	9x19	153 MM	I
17B-H919-153	9x19	Hexagonal	9x19	153 MM	I
17B-P921-153	9x19	Polygonal	9x21	153 MM	I
17B-H919-153	9x19	Hexagonal	9x21	153 MM	I
17B-H765-153	9x19	Hexagonal	7,65 Para*	153 MM	I

*9mm Magazine can be used / 9mm Magazin kann verwendet werden

Glock 34 Gen.2 – Gen.4 L=191 MM (7.5“)

Order No. Artikelnr.	From Von	Inner Profile Innenprofil	To Zu	Length Länge	Price Preis
17B-P919-191	9x19	Polygonal	9x19	191 MM	J
17B-H919-191	9x19	Hexagonal	9x19	191 MM	J
17B-P921-191	9x19	Polygonal	9x21	191 MM	J
17B-H919-191	9x19	Hexagonal	9x21	191 MM	J

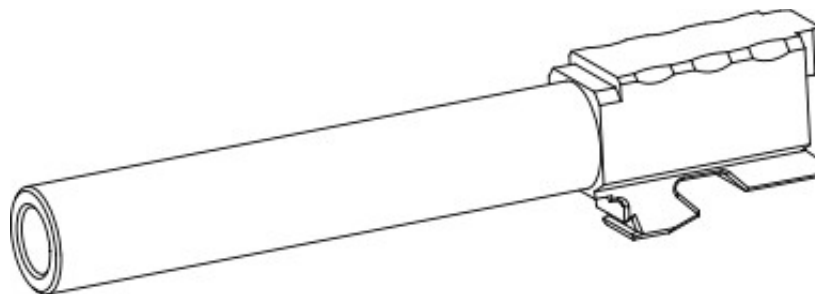

IGB BARRELS FOR GLOCK

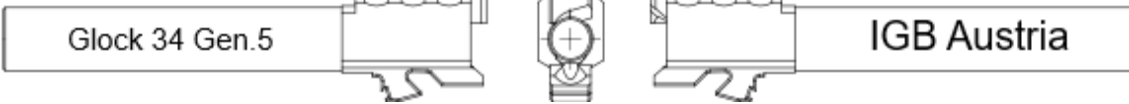

Glock 34 Gen.2 – Gen.4 Threaded / Gewinde L=149 MM (5.9“)

Caliber Kaliber	Profile Profil	Threading Gewinde	Order No. Artikelnr.	Threading Gewinde	Order No. Artikelnr.	Price Preis
9x19	Hexa	M13x1	34B-P919-149-G02	M14x1	34B-P919-149-G05	H+A01
9x19	Poly	M13x1	34B-H919-149-G02	M14x1	34B-H919-149-G05	H+A01
9x21	Hexa	M13x1	34BP921-149-G02	M14x1	34B-P921-149-G05	H+A01
9x21	Poly	M13x1	34B-H921-149-G02	M14x1	34B-H921-149-G05	H+A01
7,65 Para	Hexa	M13x1	34B-H765-149-G02	M14x1	34B-H765-149-G05	H+A01

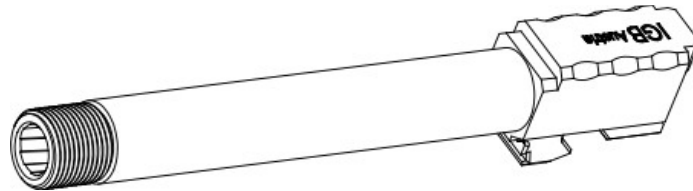

Glock 34 Gen.2 – Gen.4 Threaded / Gewinde L=149 MM (5.9“)

Caliber Kaliber	Profile Profil	Threading Gewinde	Order No. Artikelnr.	Threading Gewinde	Order No. Artikelnr.	Price Preis
9x19	Hexa	1/2x28	34B-P919-149-G01	13,5x1L	34B-P919-149-G04	H+A01
9x19	Poly	1/2x28	34B-H919-149-G01	13,5x1L	34B-H919-149-G04	H+A01
9x21	Hexa	1/2x28	34B-P921-149-G01	13,5x1L	34B-P921-149-G04	H+A01
9x21	Poly	1/2x28	34B-H921-149-G01	13,5x1L	34B-H921-149-G04	H+A01
7,65 Para	Hexa	1/2x28	34B-H765-149-G01	13,5x1L	34B-H765-149-G04	H+A01

More threadings on request / Mehr Gewinde auf Anfrage

Accessories / Zubehör

	Price / Preis
Model Shark	A09
Model Shark Compact	A09
Steel Thread Protector	A08

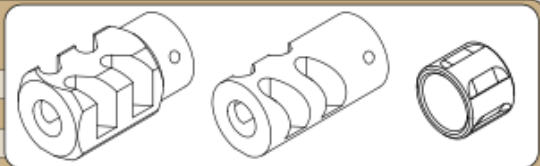

**Add Custom Surface
Oberflächenoptionen**

	Price / Preis
PVD (Gold, Silver, Tan, Bronze, ...)	Base + A05
Sandblast / Sandgestrahlt	Base + A04
Twisted Fluted / Spiralgefütet	Base + A02
Straight Fluted / Geradegefütet	Base + A02

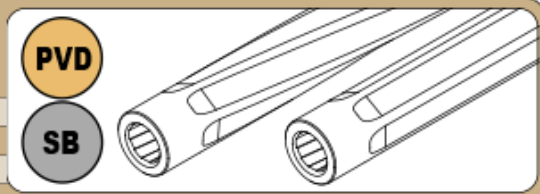

IGB BARRELS FOR GLOCK

Glock 34 Gen.5

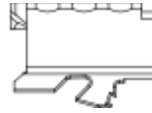
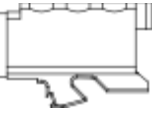

IGB Austria

Glock 34 Gen.2 – Gen.4 L=255 MM (10“) with 1/2x28 UNEF

Order No. Artikelnr.	From Von	Inner Profile Innenprofil	To Zu	Length Länge	Price Preis
34B-P919-255	9x19	Hexagonal	9x19	255 MM	K
34B-H919-255	9x19	Hexagonal	9x19	255 MM	K
34B-P921-255	9x19	Polygonal	9x21	255 MM	K
34B-H919-255	9x19	Hexagonal	9x21	255 MM	K

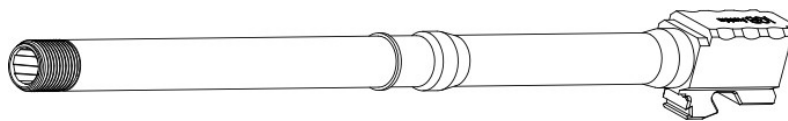

Accessories 10" Zubehör 255 MM

	Price / Preis
Muzzledevice / Schwingungsdämpfer	A09
Ported Shroud 10" / Laufmantel Geportet 255 MM	A12
Steel Thread Protector / Gewindeschutz	A08

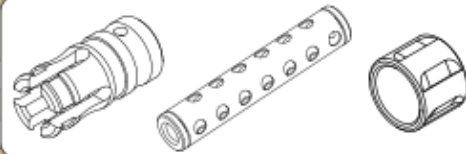

Glock 34 Gen.2 – Gen.4 L=410 MM (16“) with 1/2x28 UNEF

Order No. Artikelnr.	From Von	Inner Profile Innenprofil	To Zu	Length Länge	Price Preis
34B-P919-410	9x19	Hexagonal	9x19	410 MM	L
34B-H919-410	9x19	Hexagonal	9x19	410 MM	L
34B-P921-410	9x19	Polygonal	9x21	410 MM	L
34B-H919-410	9x19	Hexagonal	9x21	410 MM	L

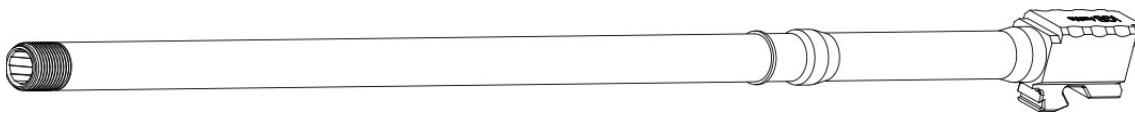

Accessories 16" Zubehör 410 MM

	Price / Preis
Muzzledevice / Schwingungsdämpfer	A09
Ported Shroud 16" / Laufmantel Geportet 410 MM	A13
Steel Thread Protector / Gewindeschutz	A08

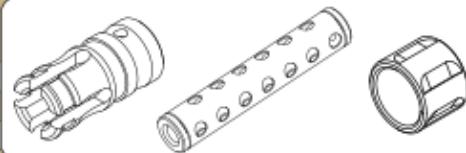

IGB .22lr SYSTEM FOR GLOCK

.22lr Conversion Set
 Containing barrel, Slide with MOS Cut, Recoilspring, Magazine for platform Glock 17 or Glock 19

.22lr Wechselsystem
 Bestehend aus Lauf, Verschluss mit MOS-Cut, Feder und Magazin für Plattform Glock 17 or Glock 19

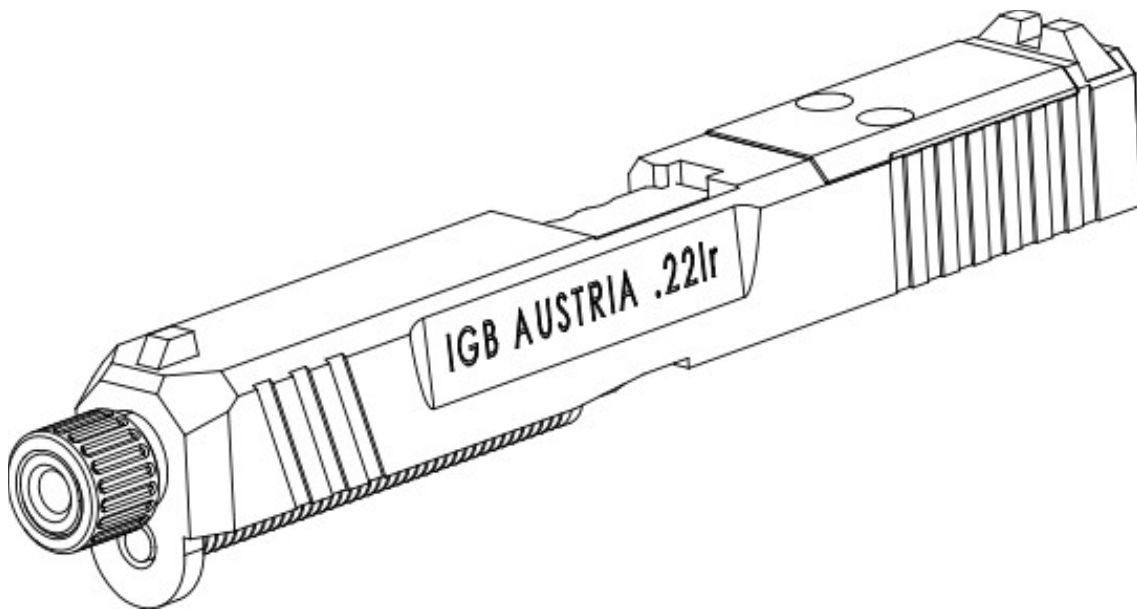

22lr Systeme

Order No. Artikelnr.	For Für	Threading Gewinde	Price Preis
WS-17A-2	Glock 17 / 34 Gen. 3-4	1/2x28 UNEF	B
WS-17B-2	Glock 17 / 34 Gen. 5	1/2x28 UNEF	B
WS-19A-2	Glock 19 Gen. 3-5 / Glock 45	1/2x28 UNEF	B

Spare Parts / Ersatzteile

Order No. Artikelnr.	Part Teil	Price Preis
WS-M10	Magazine 10rd	B01
WS--XG	Gas Piston / Gasstempel	B02
WS-V17A	Recoilspring / Vorhofeder G17 Gen3-4	B03
WS-V17B	Recoilspring / Vorhofeder G17 Gen5	B03
WS-V19A	Recoilspring / Vorhofeder G19 Gen3-5	B03
WS-XS	Striker unit / Schlagbolzeneinheit	B04
WS-XA	Extractor unit / Ausziehereinheit	B05

IGB BARRELS FOR GLOCK

Glock 35

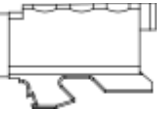

G35 .40 S&W

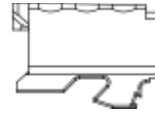

IGB Austria

Glock 35 Standard Length (135 MM)

Order No. Artikelnr.	From Von	Inner Profile Innenprofil	To Zu	Length Länge	Price Preis
35A-H040-S135	40 S&W	Hexagonal	40 S&W	135 MM	H
35A-H357-S135	40 S&W	Hexagonal	357 Sig	135 MM	H
35A-P357-S135	40 S&W	Polygonal	357 Sig	135 MM	H
35A-H919-S135	40 S&W	Hexagonal	9x19	135 MM	H
35A-P919-S135	40 S&W	Polygonal	9x19	135 MM	H
35A-H765-S135	40 S&W	Hexagonal	7,65 Para	135 MM	H

Glock 35 L=153 MM (6")

Order No. Artikelnr.	From Von	Inner Profile Innenprofil	To Zu	Length Länge	Price Preis
22A-H040-153	40 S&W	Hexagonal	40 S&W	153 MM	I
22A-H357-153	40 S&W	Hexagonal	357 Sig	153 MM	I
22A-P357-153	40 S&W	Polygonal	357 Sig	153 MM	I
22A-H919-153	40 S&W	Hexagonal	9x19	153 MM	I
22A-P919-153	40 S&W	Polygonal	9x19	153 MM	I
22A-H765-153	40 S&W	Hexagonal	7,65 Para	153 MM	I

Glock 35 L=191 MM (7.5")

Order No. Artikelnr.	From Von	Inner Profile Innenprofil	To Zu	Length Länge	Price Preis
22A-H040-191	40 S&W	Hexagonal	40 S&W	191 MM	J
22A-H357-191	40 S&W	Hexagonal	357 Sig	191 MM	J
22A-P357-191	40 S&W	Polygonal	357 Sig	191 MM	J
22A-H919-191	40 S&W	Hexagonal	9x19	191 MM	J
22A-P919-191	40 S&W	Polygonal	9x19	191 MM	J
22A-H765-191	40 S&W	Hexagonal	7,65 Para	191 MM	J

Caliberchange Kaliberwechsel

**Magazine directly from us!
Magazin gleich bei uns mitbestellen!**

Changing from bigger to smaller cartridge bottom will require you to get a smaller Magazine!
Example; **.357 Sig to 9x19 = Magazine needed / .40 to .357 Sig = No Magazine needed**

Wechsel von bestimmten Patronenbodendurchmessern benötigt ein Magazin!
Beispiel; **.357 Sig zu 9x19 = Magazin benötigt / .40 zu .357.Sig = Kein Magazin benötigt**

IGB BARRELS FOR GLOCK



Glock 35 Threaded / Gewinde L=149 MM (5.9“)

Caliber Kaliber	Profile Profil	Threading Gewinde	Order No. Artikelnr.	Threading Gewinde	Order No. Artikelnr.	Price Preis
40 S&W	Hexa	M13x1	35A-H040-149-G02	M14x1	35A-H040-149-G05	H+A01
357 Sig	Hexa	M13x1	35A-H357-149-G02	M14x1	35A-H357-149-G05	H+A01
357 Sig	Poly	M13x1	35A-P357-149-G02	M14x1	35A-P357-149-G05	H+A01
9x19	Hexa	M13x1	35A-P919-149-G02	M14x1	35A-P919-149-G05	H+A01
9x19	Poly	M13x1	35A-H919-149-G02	M14x1	35A-H919-149-G05	H+A01
7,65 Para	Hexa	M13x1	35A-H765-149-G02	M14x1	35A-H765-149-G05	H+A01

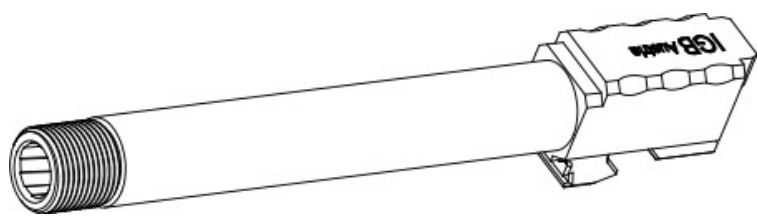

Glock 35 Threaded / Gewinde L=149 MM (5.9“)

Caliber Kaliber	Profile Profil	Threading Gewinde	Order No. Artikelnr.	Threading Gewinde	Order No. Artikelnr.	Price Preis
40 S&W	Hexa	1/2x28	35A-H040-149-G01	13,5x1L	35A-H040-149-G04	H+A01
357 Sig	Hexa	1/2x28	35A-H357-149-G01	13,5x1L	35A-H357-149-G04	H+A01
357 Sig	Poly	1/2x28	35A-P357-149-G01	13,5x1L	35A-P357-149-G04	H+A01
9x19	Hexa	1/2x28	35A-P919-149-G01	13,5x1L	35A-P919-149-G04	H+A01
9x19	Poly	1/2x28	35A-H919-149-G01	13,5x1L	35A-H919-149-G04	H+A01
7,65 Para	Hexa	1/2x28	35A-H765-149-G01	13,5x1L	35A-H765-149-G04	H+A01

More threadings on request / Mehr Gewinde auf Anfrage

Accessories / Zubehör		Price / Preis	
Model Shark		A09	
Model Shark Compact		A09	
Steel Thread Protector		A08	

Add Custom Surface Oberflächenoptionen		Price / Preis	
PVD (Gold, Silver, Tan, Bronze, ...)		Base + A05	
Sandblast / Sandgestrahlt		Base + A04	
Twisted Fluted / Spiralgefütet		Base + A02	
Straight Fluted / Geradegefütet		Base + A02	

IGB BARRELS FOR GLOCK

Glock 35

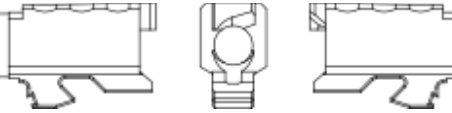

IGB Austria

Glock 35 L=255 MM (10") with 1/2x28 UNEF

Order No. Artikelnr.	From Von	Inner Profile Innenprofil	To Zu	Length Länge	Price Preis
35A-H040-255	40 S&W	Hexagonal	40 S&W	255 MM	K
35A-H357-255	40 S&W	Hexagonal	357 Sig	255 MM	K
35A-P357-255	40 S&W	Polygonal	357 Sig	255 MM	K
35A-H919-255	40 S&W	Hexagonal	9x19	255 MM	K
35A-P919-255	40 S&W	Polygonal	9x19	255 MM	K

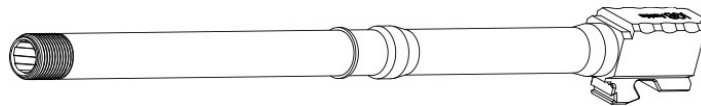

Accessories 10" Zubehör 255 MM

	Price / Preis
Muzzledevice / Schwingungsdämpfer	A09
Ported Shroud 10" / Laufmantel Geportet 255 MM	A12
Steel Thread Protector / Gewindeschutz	A08



Glock 35 L=410 MM (16") with 1/2x28 UNEF

Order No. Artikelnr.	From Von	Inner Profile Innenprofil	To Zu	Length Länge	Price Preis
35A-H040-410	40 S&W	Hexagonal	40 S&W	410 MM	L
35A-H357-410	40 S&W	Hexagonal	357 Sig	410 MM	L
35A-P357-410	40 S&W	Polygonal	357 Sig	410 MM	L
35A-H919-410	40 S&W	Hexagonal	9x19	410 MM	L
35A-P919-410	40 S&W	Polygonal	9x19	410 MM	L

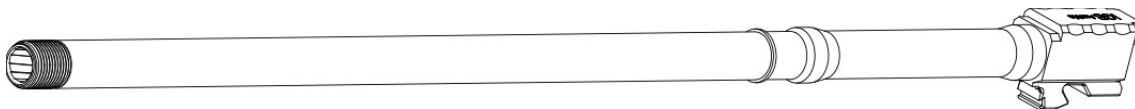

Accessories 16" Zubehör 410 MM

	Price / Preis
Muzzledevice / Schwingungsdämpfer	A09
Ported Shroud 16" / Laufmantel Geportet 410 MM	A13
Steel Thread Protector / Gewindeschutz	A08



IGB BARRELS FOR GLOCK

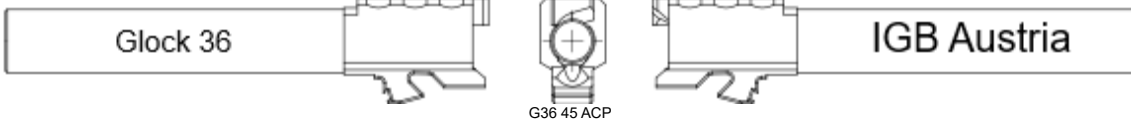

Glock 36 Standard Length (96 MM)

Order No. Artikelnr.	From Von	Inner Profile Innenprofil	To Zu	Length Länge	Price Preis
30A-H045-S096	45 acp	Hexagonal	45 acp	96 MM	H
30A-H400-S096	45 acp	Hexagonal	400 CorBon	96 MM	H

Glock 36 L=153 MM (6")

Order No. Artikelnr.	From Von	Inner Profile Innenprofil	To Zu	Length Länge	Price Preis
30A-H045-153	45 acp	Hexagonal	45 acp	153 MM	I
30A-H400-153	45 acp	Hexagonal	400 CorBon	153 MM	I

Glock 36 L=191 MM (7.5")

Order No. Artikelnr.	From Von	Inner Profile Innenprofil	To Zu	Length Länge	Price Preis
30A-H045-191	45 acp	Hexagonal	45 acp	191 MM	J
30A-H400-191	45 acp	Hexagonal	400 CorBon	191 MM	J

Glock 30 Threaded / Gewinde L=132 MM (5.2")

Caliber Kaliber	Profile Profil	Threading Gewinde	Order No. Artikelnr.	Threading Gewinde	Order No. Artikelnr.	Price Preis
45 acp	Hexa	M15x1	30A-H045-132-G07	M16x1	30A-H045-132-G09	H+A01
400 CrBn	Hexa	M15x1	30A-H400-132-G07	M16x1	30A-H400-132-G09	H+A01
Caliber Kaliber	Profile Profil	Threading Gewinde	Order No. Artikelnr.	Threading Gewinde	Order No. Artikelnr.	Price Preis
45 acp	Hexa	M14x1	30A-H045-132-G05	M14x1L	30A-H045-132-G06	H+A01
400 CrBn	Hexa	M14x1	30A-H400-132-G05	M14x1L	30A-H400-132-G06	H+A01

More threadings on request / Mehr Gewinde auf Anfrage

Add Custom Surface Oberflächenoptionen	Price / Preis
PVD (Gold, Silver, Tan, Bronze, ...)	Base + A05
Sandblast / Sandgestrahlt	Base + A04
Twisted Fluted / Spiralgefütet	Base + A02
Straight Fluted / Geradegefütet	Base + A02

PVD

SB

IGB AUSTRIA - GUIDE Threadings

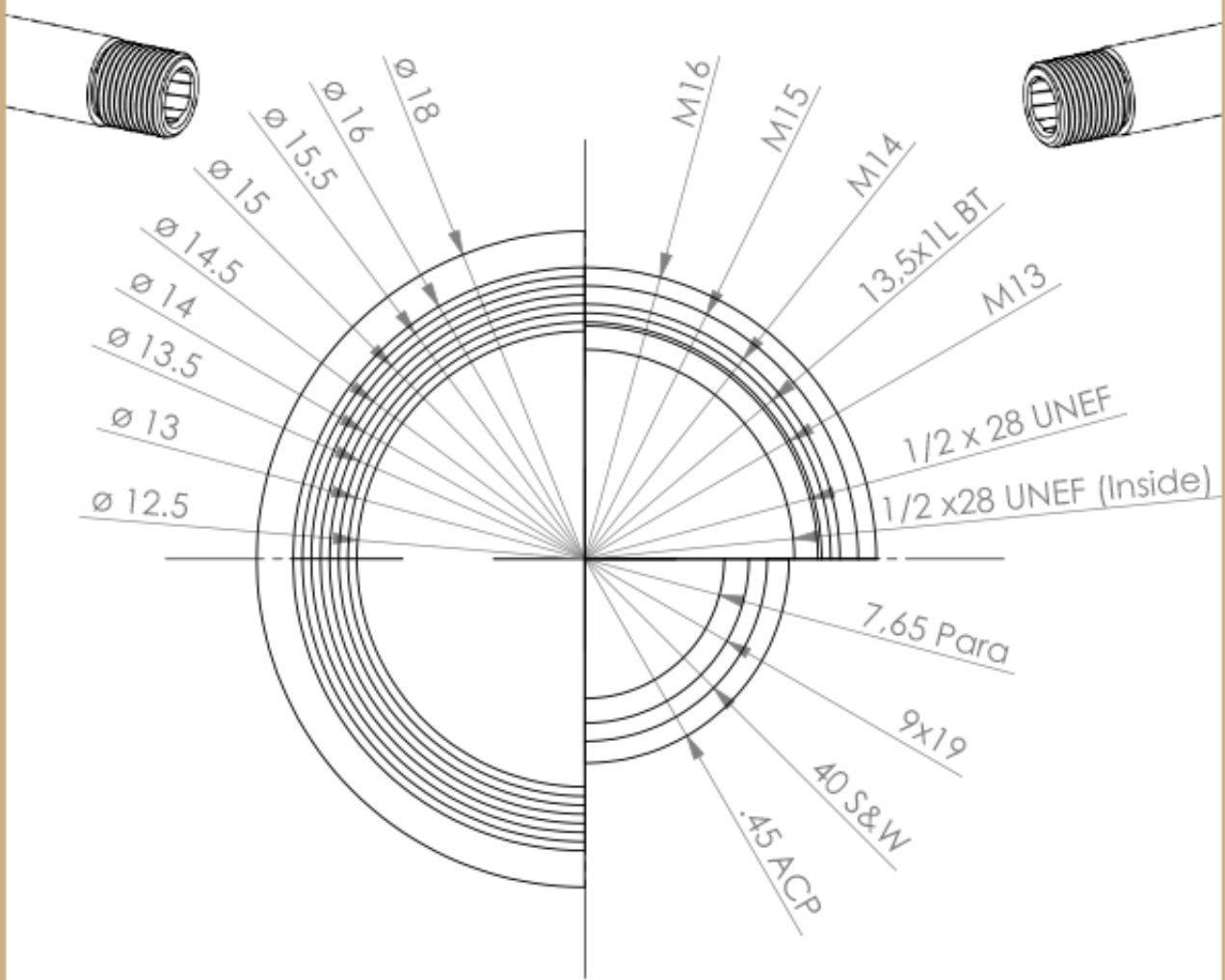

Threadings / Gewinde

Not all calibers support all threadings.
 Not all diameters support all threadings.

Example: $\frac{1}{2}$ x 28 UNEF does not fit a 12.5 mm barrel
 M15 is too big for a 14.5 mm barrel
 .45 ACP is too big for $\frac{1}{2}$ x 28 UNEF

Nicht alle Kaliber sind für gewisse Gewinde geeignet.
 Nicht alle Durchmesser sind für alle Gewinde geeignet.

Beispiel: $\frac{1}{2}$ x 28 UNEF passt nicht auf einen 12.5 mm Lauf
 M15 ist zu groß für einen 14.5 mm Lauf
 .45 ACP ist zu groß für $\frac{1}{2}$ x 28 UNEF

IGB BARRELS FOR GLOCK



Glock 20 Standard Length (153 MM)

Order No. Artikelnr.	From Von	Inner Profile Innenprofil	To Zu	Length Länge	Price Preis
40A-H010-S153	10 Auto	Hexagonal	10Auto	153 MM	I
40A-H040-S153	10 Auto	Hexagonal	40 S&W	153 MM	I
40A-P357-S153	10 Auto	Polygonal	357 Sig	153 MM	I
40A-H357-S153	10 Auto	Hexagonal	357 Sig	153 MM	I
40A-P925-S153	10 Auto	Polygonal	9x25 Dillon	153 MM	I
40A-H925-S153	10 Auto	Hexagonal	9x25 Dillon	153 MM	I

Add Custom Surface Oberflächenoptionen

	Price / Preis
PVD (Gold, Silver, Tan, Bronze, ...)	Base + A05
Sandblast / Sandgestrahlt	Base +A04
Twisted Fluted / Spiralgeflutet	Base +A02
Straight Fluted / Geradegeflutet	Base +A02

Glock 20 L=191 MM (7.5")

Order No. Artikelnr.	From Von	Inner Profile Innenprofil	To Zu	Length Länge	Price Preis
20A-H010-191	10 Auto	Hexagonal	10Auto	191 MM	J
20A-H040-191	10 Auto	Hexagonal	40 S&W	191 MM	J
20A-P357-191	10 Auto	Polygonal	357 Sig	191 MM	J
20A-H357-191	10 Auto	Hexagonal	357 Sig	191 MM	J
20A-P925-191	10 Auto	Polygonal	9x25 Dillon	191 MM	J
20A-H925-191	10 Auto	Hexagonal	9x25 Dillon	191 MM	J

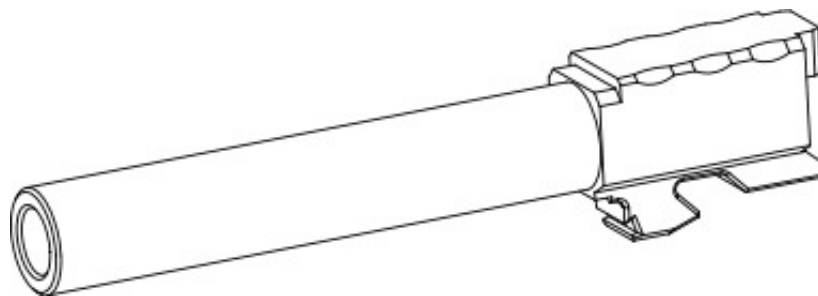

IGB BARRELS FOR GLOCK

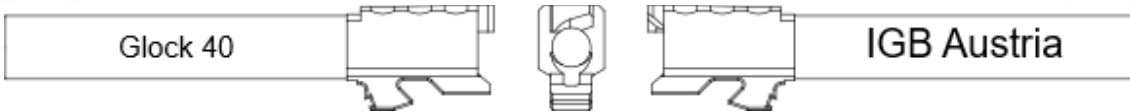

Glock 40 Threaded / Gewinde L=167 MM (6.6")

Caliber Kaliber	Profile Profil	Threading Gewinde	Order No. Artikelnr.	Threading Gewinde	Order No. Artikelnr.	Price Preis
10Auto	Hexa	M15x1	40A-H010-167-G07	M16x1	40A-H010-167-G09	H+A01
40 S&W	Hexa	M15x1	40A-H040-167-G07	M16x1	40A-H040-167-G09	H+A01
357 Sig	Poly	M15x1	40A-P357-167-G07	M16x1	40A-P357-167-G09	H+A01
357 Sig	Hexa	M15x1	40A-H357-167-G07	M16x1	40A-H357-167-G09	H+A01
9x25 DII	Poly	M15x1	40A-P925-167-G07	M16x1	40A-P925-167-G09	H+A01
9x25 DII	Hexa	M15x1	40A-H925-167-G07	M16x1	40A-H925-167-G09	H+A01

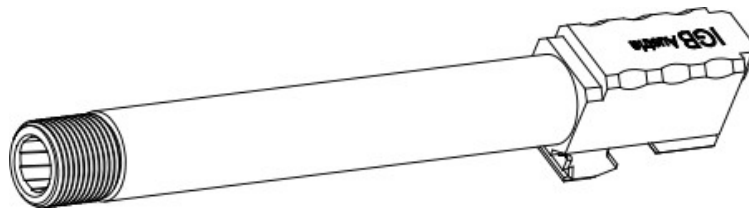

Glock 40 Threaded / Gewinde L=167 MM (6.6")

Caliber Kaliber	Profile Profil	Threading Gewinde	Order No. Artikelnr.	Threading Gewinde	Order No. Artikelnr.	Price Preis
10Auto	Hexa	M14x1	40A-H010-167-G05	M14x1L	40A-H010-167-G06	H+A01
40 S&W	Hexa	M14x1	40A-H040-167-G05	M14x1L	40A-H040-167-G06	H+A01
357 Sig	Poly	1/2x28	40A-P357-167-G01	13,5x1L	40A-P357-167-G04	H+A01
357 Sig	Hexa	1/2x28	40A-H357-167-G01	13,5x1L	40A-H357-167-G04	H+A01
9x25 DII	Poly	1/2x28	40A-P925-167-G01	13,5x1L	40A-P925-167-G04	H+A01
9x25 DII	Hexa	1/2x28	40A-H925-167-G01	13,5x1L	40A-H925-167-G04	H+A01

More threadings on request / Mehr Gewinde auf Anfrage

Accessories / Zubehör

	Price / Preis
Model Shark	A09
Model Shark Compact	A09
Steel Thread Protector	A08

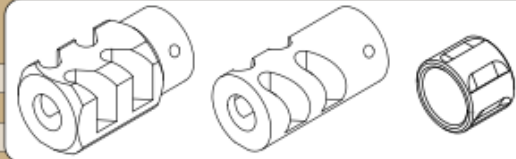

Add Custom Surface Oberflächenoptionen

	Price / Preis
PVD (Gold, Silver, Tan, Bronze, ...)	Base + A05
Sandblast / Sandgestrahlt	Base + A04
Twisted Fluted / Spiralgeflutet	Base + A02
Straight Fluted / Geradegeflutet	Base + A02

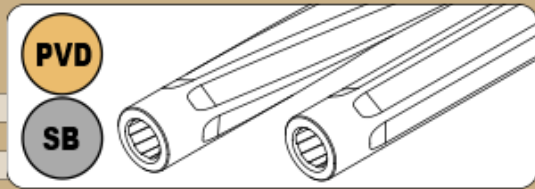

IGB BARRELS FOR GLOCK



Glock 20 L=255 MM (10") with M15x1

Order No. Artikelnr.	From Von	Inner Profile Innenprofil	To Zu	Length Länge	Price Preis
40A-H010-255	10 Auto	Hexagonal	10Auto	255 MM	K
40A-H040-255	10 Auto	Hexagonal	40 S&W	255 MM	K
40A-P357-255	10 Auto	Polygonal	357 Sig	255 MM	K
40A-H357-255	10 Auto	Hexagonal	357 Sig	255 MM	K
40A-P925-255	10 Auto	Polygonal	9x25 Dillon	255 MM	K
40A-H925-255	10 Auto	Hexagonal	9x25 Dillon	255 MM	K

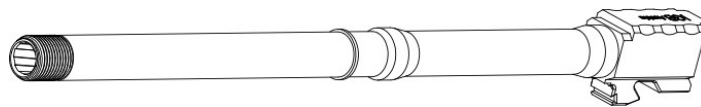

Accessories 10" Zubehör 255 MM		Price / Preis
Muzzledevice / Schwingungsdämpfer	A09	
Ported Shroud 10" / Laufmantel Geportet 255 MM	A12	
Steel Thread Protector / Gewindeschutz	A08	

Glock 20 L=410 MM (16") with M15x1

Order No. Artikelnr.	From Von	Inner Profile Innenprofil	To Zu	Length Länge	Price Preis
40A-H010-410	10 Auto	Hexagonal	10Auto	410 MM	L
40A-H040-410	10 Auto	Hexagonal	40 S&W	410 MM	L
40A-P357-410	10 Auto	Polygonal	357 Sig	410 MM	L
40A-H357-410	10 Auto	Hexagonal	357 Sig	410 MM	L
40A-P925-410	10 Auto	Polygonal	9x25 Dillon	410 MM	L
40A-H925-410	10 Auto	Hexagonal	9x25 Dillon	410 MM	L

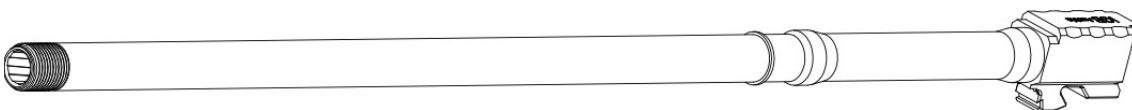

Accessories 16" Zubehör 410 MM		Price / Preis
Muzzledevice / Schwingungsdämpfer	A09	
Ported Shroud 16" / Laufmantel Geportet 410 MM	A13	
Steel Thread Protector / Gewindeschutz	A08	

IGB BARRELS FOR GLOCK

Glock 41

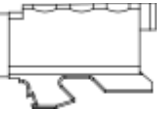

G41 45 ACP

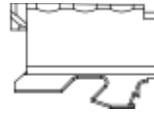

IGB Austria

Glock 41 Standard Length (135 MM)

Order No. Artikelnr.	From Von	Inner Profile Innenprofil	To Zu	Length Länge	Price Preis
41A-H045-S135	45 acp	Hexagonal	45 acp	135 MM	H
41A-H400-S135	45 acp	Hexagonal	400 CorBon	135 MM	H
41A-H010-S135	45 acp	Hexagonal	10Auto	135 MM	H
41A-H040-S135	45 acp	Hexagonal	40 S&W	135 MM	H
41A-P357-S135	45 acp	Polygonal	357 Sig	135 MM	H
41A-H357-S135	45 acp	Hexagonal	357 Sig	135 MM	H
41A-P925-S135	45 acp	Polygonal	9x25 Dillon	135 MM	H
41A-H925-S135	45 acp	Hexagonal	9x25 Dillon	135 MM	H

Glock 21 L=153 MM (6")

Order No. Artikelnr.	From Von	Inner Profile Innenprofil	To Zu	Length Länge	Price Preis
41A-H045-153	45 acp	Hexagonal	45 acp	153 MM	I
41A-H400-153	45 acp	Hexagonal	400 CorBon	153 MM	I
41A-H010-153	45 acp	Hexagonal	10Auto	153 MM	I
41A-H040-153	45 acp	Hexagonal	40 S&W	153 MM	I
41A-P357-153	45 acp	Polygonal	357 Sig	153 MM	I
41A-H357-153	45 acp	Hexagonal	357 Sig	153 MM	I
41A-P925-153	45 acp	Polygonal	9x25 Dillon	153 MM	I
41A-H925-153	45 acp	Hexagonal	9x25 Dillon	153 MM	I

Glock 21 L=191 MM (7.5")

Order No. Artikelnr.	From Von	Inner Profile Innenprofil	To Zu	Length Länge	Price Preis
41A-H045-191	45 acp	Hexagonal	45 acp	191 MM	J
41A-H400-191	45 acp	Hexagonal	400 CorBon	191 MM	J
41A-H010-191	45 acp	Hexagonal	10Auto	191 MM	J
41A-H040-191	45 acp	Hexagonal	40 S&W	191 MM	J
41A-P357-191	45 acp	Polygonal	357 Sig	191 MM	J
41A-H357-191	45 acp	Hexagonal	357 Sig	191 MM	J
41A-P925-191	45 acp	Polygonal	9x25 Dillon	191 MM	J
41A-H925-191	45 acp	Hexagonal	9x25 Dillon	191 MM	J

IGB BARRELS FOR GLOCK



**Caliberchange
Kaliberwechsel**

**Magazine directly from us!
Magazin gleich bei uns mitbestellen!**

Changing from bigger to smaller cartridge bottom will require you to get a smaller Magazine!
 Example; .45 to .357 Sig = Magazine needed / .45 to 400 CorBon = No Magazine needed

Wechsel von bestimmten Patronenbodendurchmessern benötigt ein Magazin!
 Beispiel; .45 zu .357 Sig = Magazin benötigt / .45 zu 400 CorBon = Kein Magazin benötigt

Glock 41 Threaded / Gewinde L=167 MM (6.6")

Caliber Kaliber	Profile Profil	Threading Gewinde	Order No. Artikelnr.	
45 acp	Hexa	M15x1	21A-H045-132-G07	H+A01
400 CrBn	Hexa	M15x1	21A-H400-132-G07	H+A01
10 Auto	Hexa	M15x1	21A-H010-132-G07	H+A01
40 S&W	Hexa	M15x1	21A-H040-132-G07	H+A01
357 Sig	Poly	M15x1	21A-P357-132-G07	H+A01
357 Sig	Hexa	M15x1	21A-H357-132-G07	H+A01
9x25 Dll	Poly	M15x1	21A-P925-132-G07	H+A01
9x25 Dll	Hexa	M15x1	21A-H925-132-G07	H+A01

Caliber Kaliber	Profile Profil	Threading Gewinde	Order No. Artikelnr.	Threading Gewinde	Order No. Artikelnr.	Price Preis
45 acp	Hexa	M14x1	21A-H045-132-G05	M14x1L	21A-H045-132-G06	H+A01
400 CrBn	Hexa	M14x1	21A-H400-132-G05	M14x1L	21A-H400-132-G06	H+A01
10 Auto	Hexa	M14x1	21A-H010-132-G05	M14x1L	21A-H010-132-G06	H+A01
40 S&W	Hexa	M14x1	21A-H040-132-G05	M14x1L	21A-H040-132-G06	H+A01
357 Sig	Poly	1/2x28	21A-P357-132-G01	13,5x1L	21A-P357-132-G04	H+A01
357 Sig	Hexa	1/2x28	21A-H357-132-G01	13,5x1L	21A-H357-132-G04	H+A01
9x25 Dll	Poly	1/2x28	21A-P925-132-G01	13,5x1L	21A-P925-132-G04	H+A01
9x25 Dll	Hexa	1/2x28	21A-H925-132-G01	13,5x1L	21A-H925-132-G04	H+A01

More threadings on request / Mehr Gewinde auf Anfrage

Add Custom Surface Oberflächenoptionen	Price / Preis
PVD (Gold, Silver, Tan, Bronze, ...)	Base + A05
Sandblast / Sandgestrahlt	Base +A04
Twisted Fluted / Spiralgefütet	Base +A02
Straight Fluted / Geradegefütet	Base +A02

PVD

SB

IGB BARRELS FOR GLOCK

Glock 41

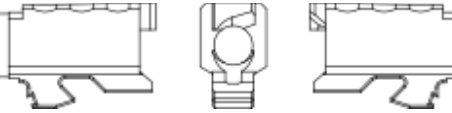

IGB Austria

Glock 41 L=255 MM (10“) with M15x1

Order No. Artikelnr.	From Von	Inner Profile Innenprofil	To Zu	Length Länge	Price Preis
41A-H045-255	45 acp	Hexagonal	45 acp	255 MM	K
41A-H400-255	45 acp	Hexagonal	400 CorBon	255 MM	K
41A-H010-255	45 acp	Hexagonal	10Auto	255 MM	K
41A-H040-255	45 acp	Hexagonal	40 S&W	255 MM	K
41A-P357-255	45 acp	Polygonal	357 Sig	255 MM	K
41A-H357-255	45 acp	Hexagonal	357 Sig	255 MM	K
41A-P925-255	45 acp	Polygonal	9x25 Dillon	255 MM	K
41A-H925-255	45 acp	Hexagonal	9x25 Dillon	255 MM	K

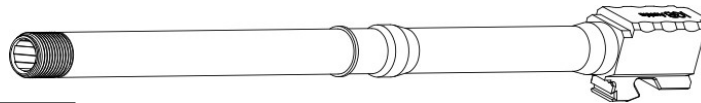

Accessories 10“ Zubehör 255 MM

	Price / Preis
Muzzledevice / Schwingungsdämpfer	A09
Ported Shroud 10“ / Laufmantel Geportet 255 MM	A12
Steel Thread Protector / Gewindeschutz	A08

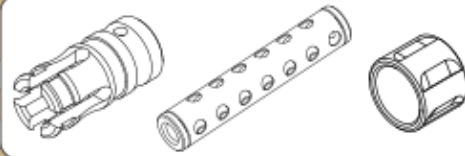

Glock 41 L=410 MM (16“) with M15x1

Order No. Artikelnr.	From Von	Inner Profile Innenprofil	To Zu	Length Länge	Price Preis
41A-H045-410	45 acp	Hexagonal	45 acp	410 MM	L
41A-H400-410	45 acp	Hexagonal	400 CorBon	410 MM	L
41A-H010-410	45 acp	Hexagonal	10Auto	410 MM	L
41A-H040-410	45 acp	Hexagonal	40 S&W	410 MM	L
41A-P357-410	45 acp	Polygonal	357 Sig	410 MM	L
41A-H357-410	45 acp	Hexagonal	357 Sig	410 MM	L
41A-P925-410	45 acp	Polygonal	9x25 Dillon	410 MM	L
41A-H925-410	45 acp	Hexagonal	9x25 Dillon	410 MM	L

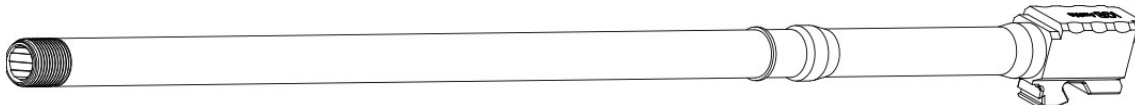

Accessories 16“ Zubehör 410 MM

	Price / Preis
Muzzledevice / Schwingungsdämpfer	A09
Ported Shroud 16“ / Laufmantel Geportet 410 MM	A13
Steel Thread Protector / Gewindeschutz	A08

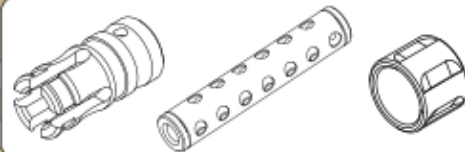

IGB BARRELS FOR GLOCK

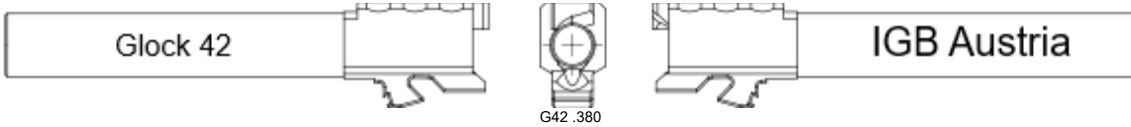

Glock 42 Standard Length (82 MM)

Order No. Artikelnr.	From Von	Inner Profile Innenprofil	To Zu	Length Länge	Price Preis
42A-P380-S082	.380	Polygonal	.380	82 MM	H
42A-H380-S082	.380	Hexagonal	.380	82 MM	H



Glock 42 Threaded / Gewinde L=96 MM (3.8")

Caliber Kaliber	Profile Profil	Threading Gewinde	Order No. Artikelnr.	Price Preis
.380	Hexa	1/2x28	42A-P380-096-G01	H+A01
.380	Poly	1/2x28	42A-H380-096-G01	H+A01



More threadings on request / Mehr Gewinde auf Anfrage

**Add Custom Surface
Oberflächenoptionen**

	Price / Preis
PVD (Gold, Silver, Tan, Bronze, ...)	Base +A05
Sandblast / Sandgestrahlt	Base +A04
Twisted Fluted / Spiralgefütet	Base +A02
Straight Fluted / Geradegefütet	Base +A02

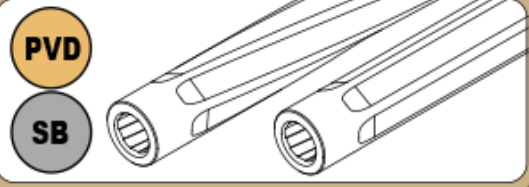

**Additional Options /
Zusätzliche Optionen**

	Price / Preis
Straight Fluted / Geradegefütet	Base +A03
Twisted Fluted / Spiralgefütet	Base +A03
3 Muzzleports / 3 Mündungsschlitze	Base +A02
5 Muzzleports / 5 Mündungsschlitze	Base +A02

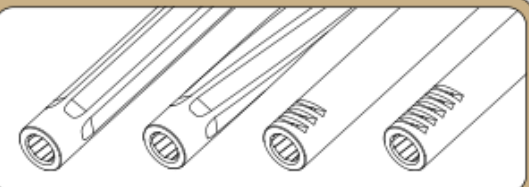

IGB BARRELS IDEAS

Make it YOUR Gun with the IGB Variety
 Machen Sie es zu IHRER Pistole mit den IGB Variationen.

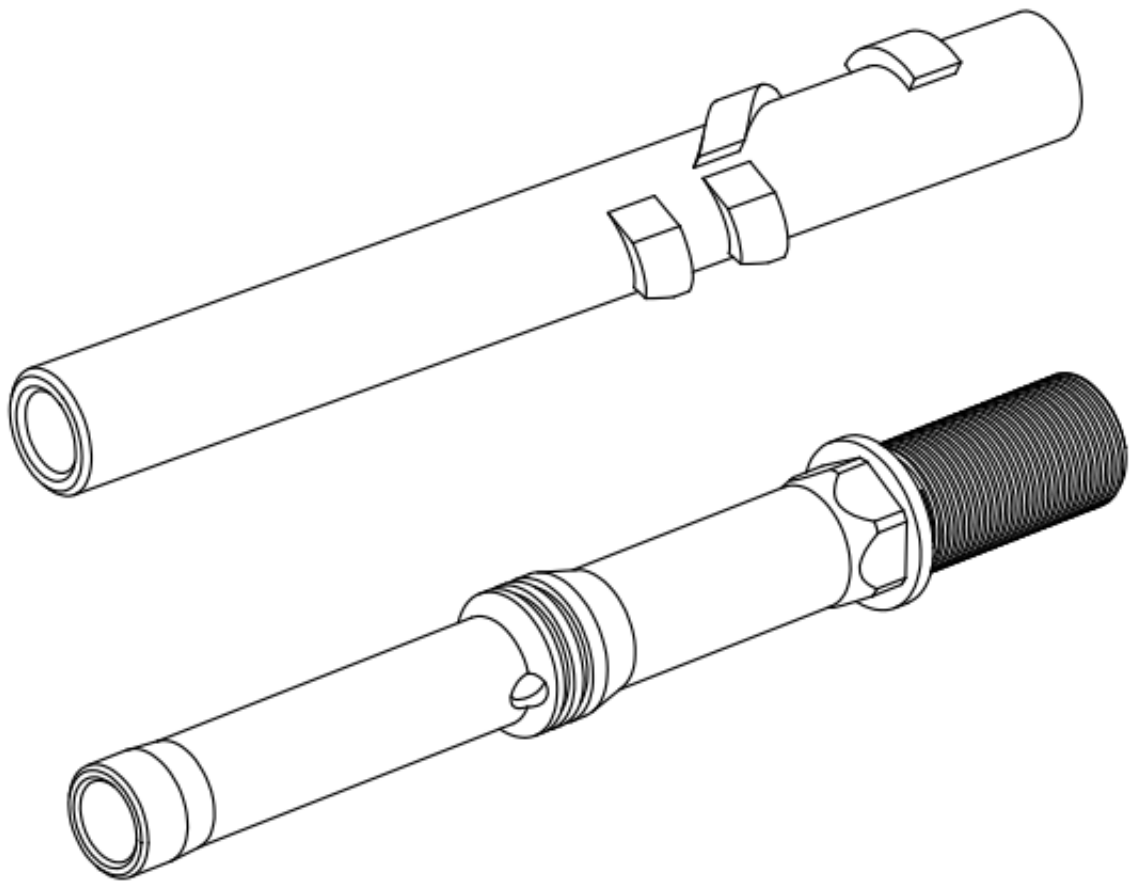

Polygonal vs Hexagonal

Polygonal is very smooth inside and therefore very gastight for high velocity.
 Polygonal ist formbedingt sehr Gasdicht für hohe Geschwindigkeiten.

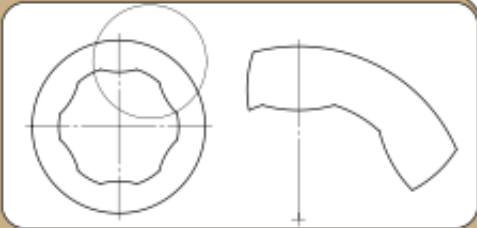
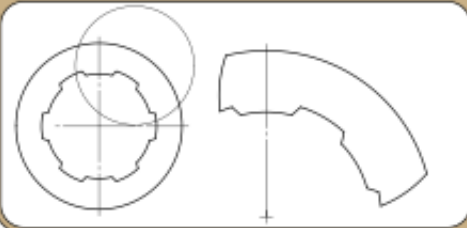

Hexagonal is the more classic approach and also well suited for pure lead.
 Hexagonal ist der klassischere Ansatz und gut geeignet für reine Bleigeschoße.

IGB BARRELS FOR GLOCK

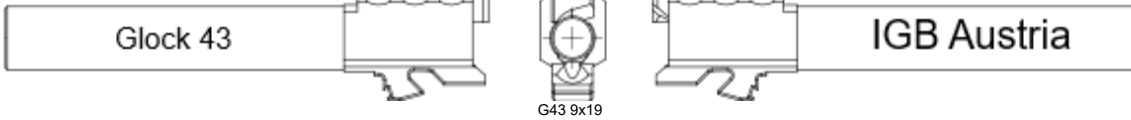

Glock 43 Standard Length (87 MM)

Order No. Artikelnr.	From Von	Inner Profile Innenprofil	To Zu	Length Länge	Price Preis
43A-P919-S087	9x19	Polygonal	9x19	87 MM	H
43A-H919-S087	9x19	Hexagonal	9x19	87 MM	H
43A-P380-S087	9x19	Polygonal	.380*	87 MM	H
43A-H380-S087	9x19	Hexagonal	.380*	87 MM	H
43A-H765-S087	9x19	Hexagonal	7,65 Para*	87 MM	H
43A-H9M-S087	9x19	Hexagonal	9 Makarov*	87 MM	H

*9mm Magazine can be used / 9mm Magazin kann verwendet werden

Glock 43 L=153 MM (6")

Order No. Artikelnr.	From Von	Inner Profile Innenprofil	To Zu	Length Länge	Price Preis
43A-P919-153	9x19	Polygonal	9x19	153 MM	I
43A-H919-153	9x19	Hexagonal	9x19	153 MM	I
43A-P380-153	9x19	Polygonal	.380*	153 MM	I
43A-H380-153	9x19	Hexagonal	.380*	153 MM	I
43A-H765-153	9x19	Hexagonal	7,65 Para*	153 MM	I
43A-H9M-153	9x19	Hexagonal	9 Makarov*	153 MM	I

*9mm Magazine can be used / 9mm Magazin kann verwendet werden

Glock 43 / Gewinde L=101 MM (4")

Caliber Kaliber	Profile Profil	Threading Gewinde	Order No. Artikelnr.	Threading Gewinde	Order No. Artikelnr.	Price Preis
9x19	Hexa	1/2x28	43A-P919-101-G01	M13x1	43A-P919-101-G02	H+A01
9x19	Poly	1/2x28	43A-H919-101-G01	M13x1	43A-H919-101-G02	H+A01
.380	Hexa	1/2x28	43A-P380-101-G01	M13x1	43A-P380-101-G02	H+A01
.380	Poly	1/2x28	43A-H380-101-G01	M13x1	43A-H380-101-G02	H+A01
7,65 Para	Hexa	1/2x28	43A-H765-101-G01	M13x1	43A-H765-101-G02	H+A01
9 Mak	Hexa	1/2x28	43A-H9M-101-G01	M13x1	43A-H9M-101-G02	H+A01

**Add Custom Surface
Oberflächenoptionen**

	Price / Preis
PVD (Gold, Silver, Tan, Bronze, ...)	Base + A05
Sandblast / Sandgestrahlt	Base +A04
Twisted Fluted / Spiralgefütet	Base +A02
Straight Fluted / Geradegefütet	Base +A02

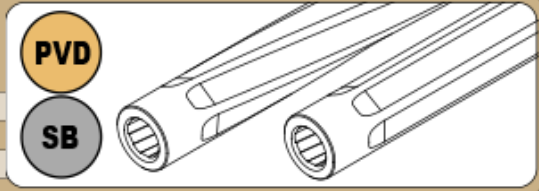

IGB BARRELS FOR GLOCK

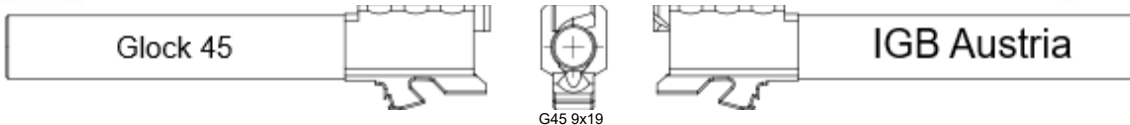

Glock 45 Standard Length (102 MM)

Order No. Artikelnr.	From Von	Inner Profile Innenprofil	To Zu	Length Länge	Price Preis
19A-P919-S102	9x19	Polygonal	9x19	102 MM	H
19A-H919-S102	9x19	Hexagonal	9x19	102 MM	H
19A-P380-S102	9x19	Polygonal	.380*	102 MM	H
19A-H380-S102	9x19	Hexagonal	.380*	102 MM	H
19A-H765-S102	9x19	Hexagonal	7,65 Para*	102 MM	H
19A-H9M-S102	9x19	Hexagonal	9 Makarov*	102 MM	H

*9mm Magazine can be used / 9mm Magazin kann verwendet werden

Glock 45 L=153 MM (6")

Order No. Artikelnr.	From Von	Inner Profile Innenprofil	To Zu	Length Länge	Price Preis
19A-P919-153	9x19	Polygonal	9x19	153 MM	I
19A-H919-153	9x19	Hexagonal	9x19	153 MM	I
19A-P380-153	9x19	Polygonal	.380*	153 MM	I
19A-H380-153	9x19	Hexagonal	.380*	153 MM	I
19A-H765-153	9x19	Hexagonal	7,65 Para*	153 MM	I
19A-H9M-153	9x19	Hexagonal	9 Makarov*	153 MM	I

*9mm Magazine can be used / 9mm Magazin kann verwendet werden

Glock 45 L=191 MM (7.5")

Order No. Artikelnr.	From Von	Inner Profile Innenprofil	To Zu	Length Länge	Price Preis
19A-P919-191	9x19	Polygonal	9x19	191 MM	J
19A-H919-191	9x19	Hexagonal	9x19	191 MM	J
19A-P919-191	9x19	Polygonal	9x21	191 MM	J
19A-H919-191	9x19	Hexagonal	9x21	191 MM	J



IGB BARRELS FOR GLOCK



Glock 45 Threaded / Gewinde L=116 MM (4.6")

Caliber Kaliber	Profile Profil	Threading Gewinde	Order No. Artikelnr.	Threading Gewinde	Order No. Artikelnr.	Price Preis
9x19	Hexa	M13x1	19A-P919-116-G02	M14x1	19A-P919-116-G05	H+A01
9x19	Poly	M13x1	19A-H919-116-G02	M14x1	19A-H919-116-G05	H+A01
.380	Hexa	M13x1	19A-H380-116-G02	M14x1	19A-H380-116-G05	H+A01
.380	Poly	M13x1	19A-P380-116-G02	M14x1	19A-P380-116-G05	H+A01
7,65 Para	Hexa	M13x1	19A-H765-116-G02	M14x1	19A-H765-116-G05	H+A01
9 Mak	Hexa	M13x1	19A-H9M-116-G02	M14x1	19A-H9M-116-G05	H+A01

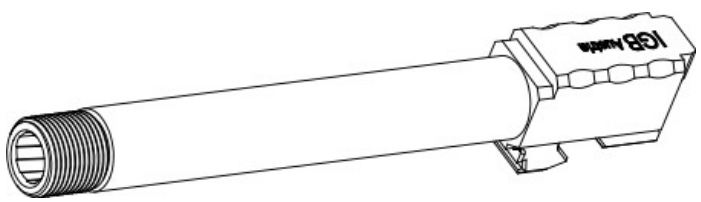

Glock 45 Threaded / Gewinde L=116 MM (4.6")

Caliber Kaliber	Profile Profil	Threading Gewinde	Order No. Artikelnr.	Threading Gewinde	Order No. Artikelnr.	Price Preis
9x19	Hexa	1/2x28	19A-P919-116-G01	13,5x1L	19A-P919-116-G04	H+A01
9x19	Poly	1/2x28	19A-H919-116-G01	13,5x1L	19A-H919-116-G04	H+A01
.380	Hexa	1/2x28	19A-H380-116-G01	13,5x1L	19A-H380-116-G04	H+A01
.380	Poly	1/2x28	19A-P380-116-G01	13,5x1L	19A-P380-116-G04	H+A01
7,65 Para	Hexa	1/2x28	19A-H765-116-G01	13,5x1L	19A-H765-116-G04	H+A01
9 Mak	Hexa	1/2x28	19A-H9M-116-G01	13,5x1L	19A-H9M-116-G04	H+A01

More threadings on request / Mehr Gewinde auf Anfrage

Accessories / Zubehör		Price / Preis
Model Shark		A09
Model Shark Compact		A09
Steel Thread Protector		A08

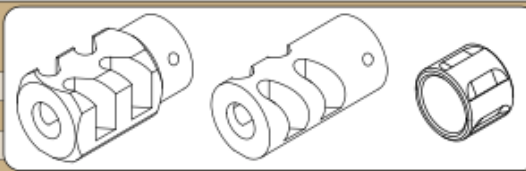

Add Custom Surface Oberflächenoptionen		Price / Preis
PVD (Gold, Silver, Tan, Bronze, ...)		Base + A05
Sandblast / Sandgestrahlt		Base +A04
Twisted Fluted / Spiralgefütet		Base +A02
Straight Fluted / Geradegefütet		Base +A02

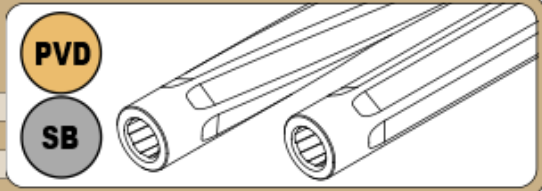

IGB BARRELS FOR GLOCK

Glock 45

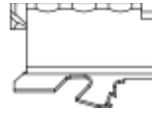
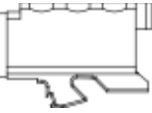

IGB Austria

Glock 45 L=255 MM (10“) with 1/2x28 UNEF

Order No. Artikelnr.	From Von	Inner Profile Innenprofil	To Zu	Length Länge	Price Preis
19A-P919-255	9x19	Hexagonal	9x19	255 MM	K
19A-H919-255	9x19	Hexagonal	9x19	255 MM	K
19A-P919-255	9x19	Polygonal	9x21	255 MM	K
19A-H919-255	9x19	Hexagonal	9x21	255 MM	K

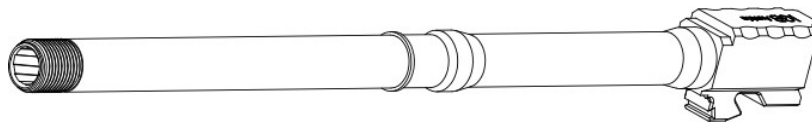

Accessories 10“ Zubehör 255 MM

	Price / Preis
Muzzledevice / Schwingungsdämpfer	A09
Ported Shroud 10“ / Laufmantel Geportet 255 MM	A12
Steel Thread Protector / Gewindeschutz	A08

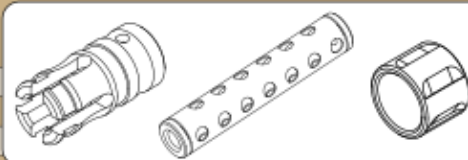

Glock 45 L=410 MM (16“) with 1/2x28 UNEF

Order No. Artikelnr.	From Von	Inner Profile Innenprofil	To Zu	Length Länge	Price Preis
19A-P919-410	9x19	Hexagonal	9x19	410 MM	L
19A-H919-410	9x19	Hexagonal	9x19	410 MM	L
19A-P919-410	9x19	Polygonal	9x21	410 MM	L
19A-H919-410	9x19	Hexagonal	9x21	410 MM	L

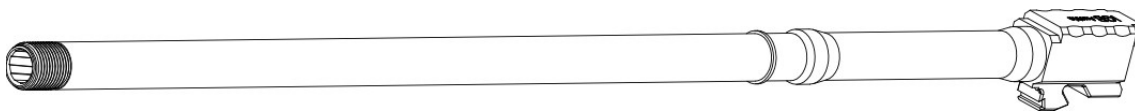

Accessories 16“ Zubehör 410 MM

	Price / Preis
Muzzledevice / Schwingungsdämpfer	A09
Ported Shroud 16“ / Laufmantel Geportet 410 MM	A13
Steel Thread Protector / Gewindeschutz	A08

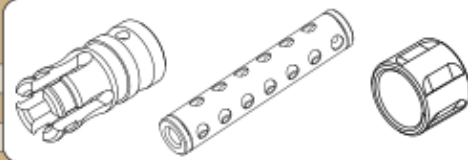

IGB .22lr SYSTEM FOR GLOCK

.22lr Conversion Set
 Containing barrel, Slide with MOS Cut, Recoilspring, Magazine for platform Glock 17 or Glock 19

.22lr Wechselsystem
 Bestehend aus Lauf, Verschluss mit MOS-Cut, Feder und Magazin für Plattform Glock 17 or Glock 19

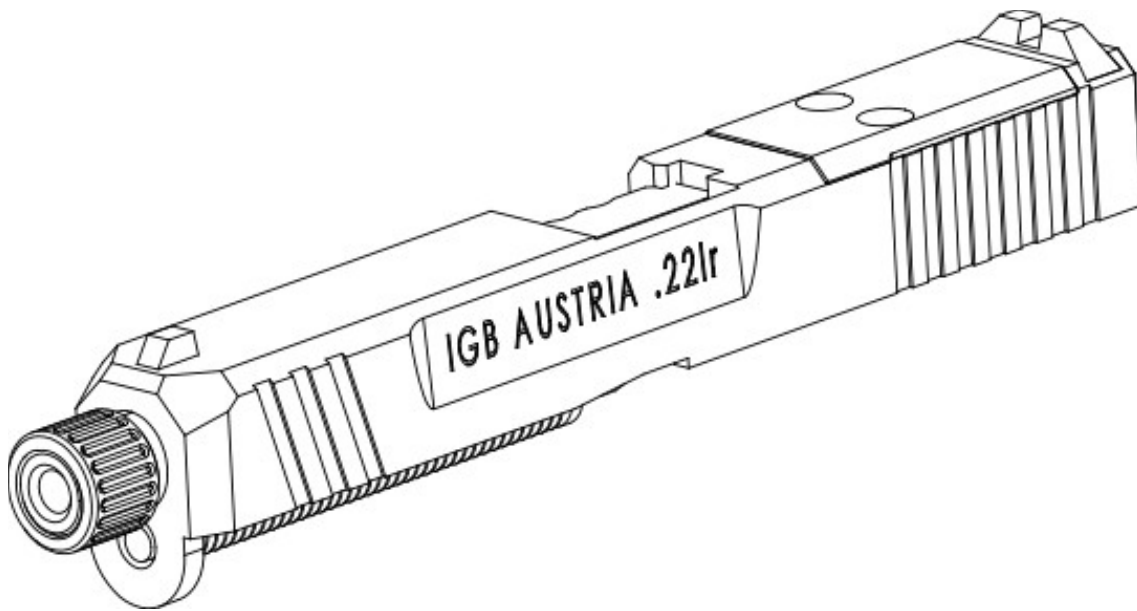

22lr Systeme

Order No. Artikelnr.	For Für	Threading Gewinde	Price Preis
WS-17A-2	Glock 17 / 34 Gen. 3-4	1/2x28 UNEF	B
WS-17B-2	Glock 17 / 34 Gen. 5	1/2x28 UNEF	B
WS-19A-2	Glock 19 Gen. 3-5 / Glock 45	1/2x28 UNEF	B

Spare Parts / Ersatzteile

Order No. Artikelnr.	Part Teil	Price Preis
WS-M10	Magazine 10rd	B01
WS--XG	Gas Piston / Gasstempel	B02
WS-V17A	Recoilspring / Vorhofeder G17 Gen3-4	B03
WS-V17B	Recoilspring / Vorhofeder G17 Gen5	B03
WS-V19A	Recoilspring / Vorhofeder G19 Gen3-5	B03
WS-XS	Striker unit / Schlagbolzeneinheit	B04
WS-XA	Extractor unit / Ausziehereinheit	B05

IGB BARRELS FOR GLOCK

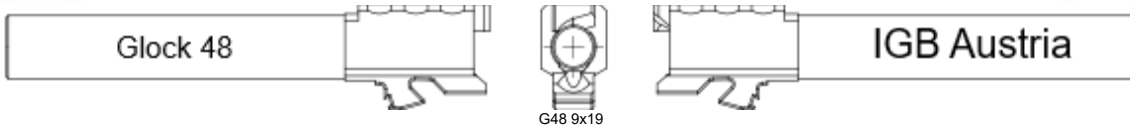

Glock 48 Standard Length (106 MM)

Order No. Artikelnr.	From Von	Inner Profile Innenprofil	To Zu	Length Länge	Price Preis
48A-P919-S106	9x19	Polygonal	9x19	106 MM	H
48A-H919-S106	9x19	Hexagonal	9x19	106 MM	H
48A-P380-S106	9x19	Polygonal	.380*	106 MM	H
48A-H380-S106	9x19	Hexagonal	.380*	106 MM	H
48A-H765-S106	9x19	Hexagonal	7,65 Para*	106 MM	H
48A-H9M-S106	9x19	Hexagonal	9 Makarov*	106 MM	H

*9mm Magazine can be used / 9mm Magazin kann verwendet werden

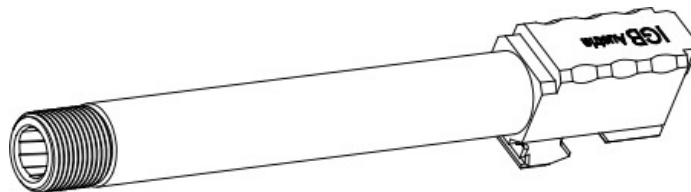

Glock 48 Threaded / Gewinde L=116 MM (4.6")

Caliber Kaliber	Profile Profil	Threading Gewinde	Order No. Artikelnr.	Threading Gewinde	Order No. Artikelnr.	Price Preis
9x19	Hexa	1/2x28	48A-P919-106-G01	M13x1	48A-P919-106-G02	H+A01
9x19	Poly	1/2x28	48A-H919-106-G01	M13x1	48A-H919-106-G02	H+A01
.380	Hexa	1/2x28	48A-P380-106-G01	M13x1	48A-P380-106-G02	H+A01
.380	Poly	1/2x28	48A-H380-106-G01	M13x1	48A-H380-106-G02	H+A01
7,65 Para	Hexa	1/2x28	48A-H765-106-G01	M13x1	48A-H765-106-G02	H+A01
9 Mak	Hexa	1/2x28	48A-H9M-106-G01	M13x1	48A-H9M-106-G02	H+A01

More threadings on request / Mehr Gewinde auf Anfrage

Add Custom Surface Oberflächenoptionen		Price / Preis
PVD (Gold, Silver, Tan, Bronze, ...)	Base +A05	
Sandblast / Sandgestrahlt	Base +A04	
Twisted Fluted / Spiralgefütet	Base +A02	
Straight Fluted / Geradegefütet	Base +A02	

IGB BARRELS IDEAS

Make it YOUR Gun with the IGB Variety
 Machen Sie es zu IHRER Pistole mit den IGB Variationen.

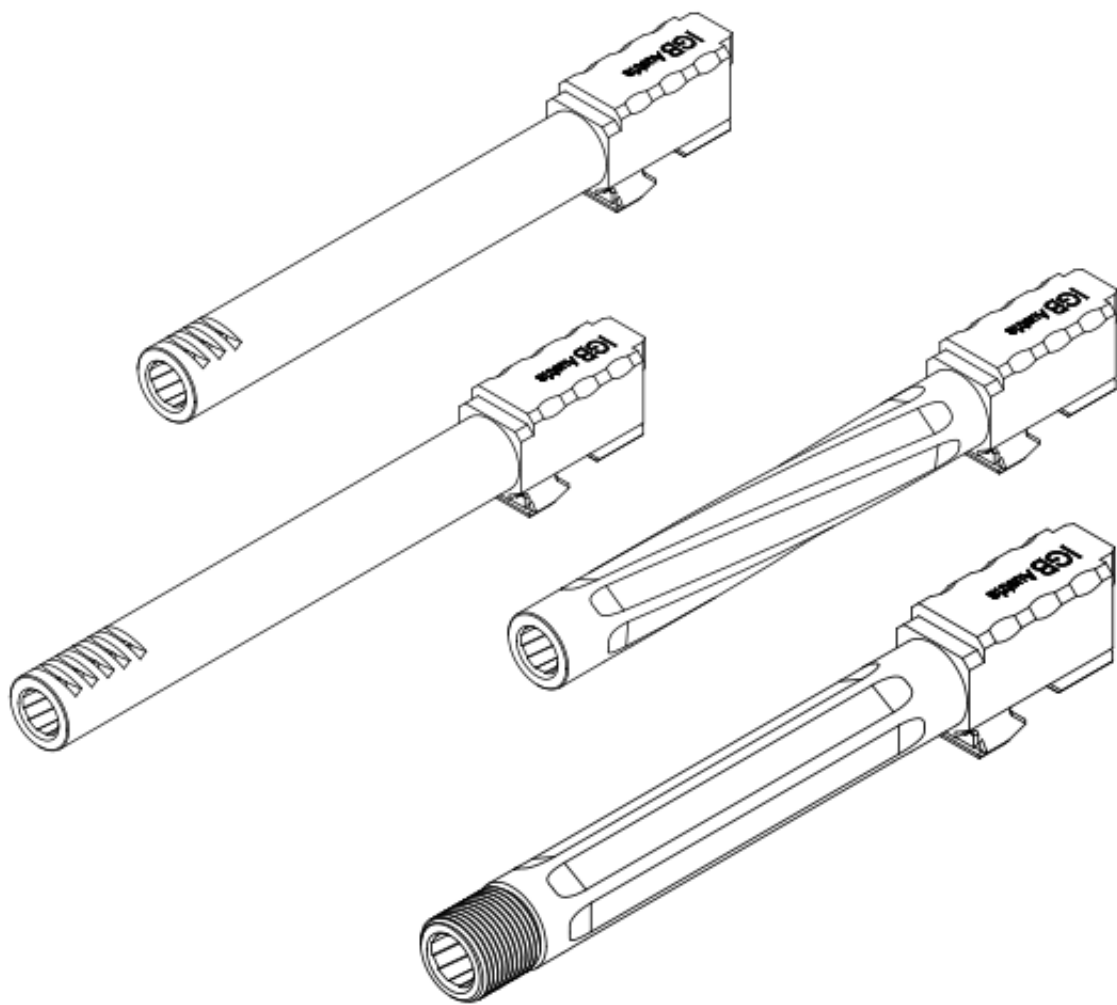

**Additional Options /
Zusätzliche Optionen**

	Price / Preis
Straight Fluted / Geradegeflutet	Base +A03
Twisted Fluted / Spiralgeflutet	Base +A03
3 Muzzleports / 3 Mündungsschlitze	Base +A02
5 Muzzleports / 5 Mündungsschlitze	Base +A02

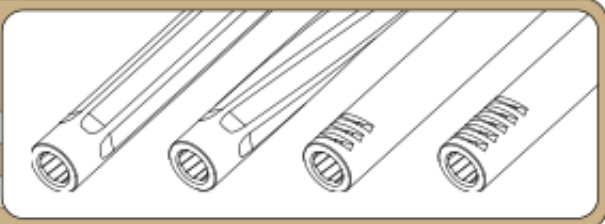

**Add Custom Surface
Oberflächenoptionen**

	Price / Preis
PVD (Gold, Silver, Tan, Bronze, ...)	Base + A05
Sandblast / Sandgestrahlt	Base +A04
Twisted Fluted / Spiralgeflutet	Base +A02
Straight Fluted / Geradegeflutet	Base +A02

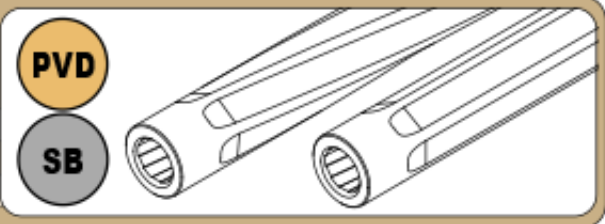

IGB BARRELS FOR CZ

CZ



IGB Austria

Barreltechnology

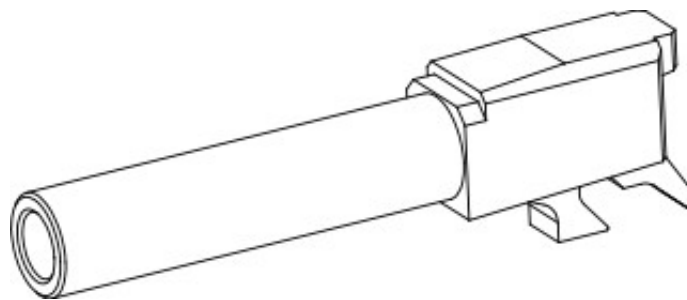
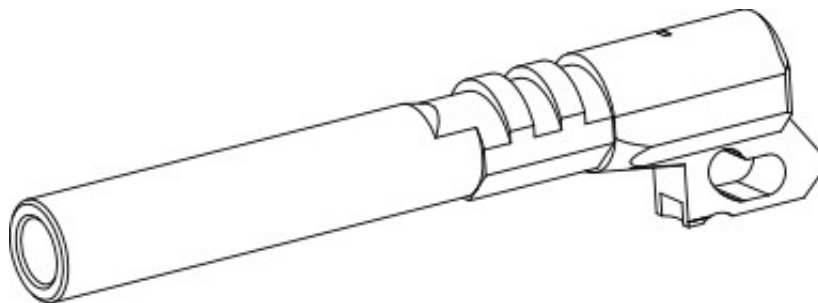

IGB BARRELS FOR CZ

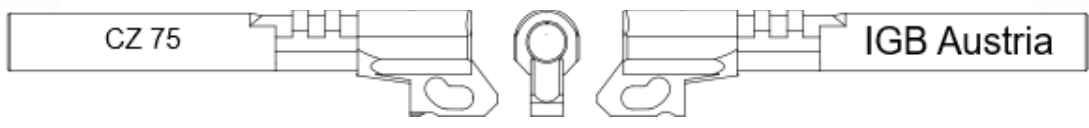

CZ 75 - 9x19

CZ 75 - 9x19 Standard Length (120 MM)

Order No. Artikelnr.	From Von	Inner Profile Innenprofil	To Zu	Length Länge	Price Preis
Z01-P919-S120	9x19	Polygonal	9x19	120 MM	G
Z01-H919-S120	9x19	Hexagonal	9x19	120 MM	G
Z01-P921-S120	9x19	Polygonal	9x21	120 MM	G
Z01-H919-S120	9x19	Hexagonal	9x21	120 MM	G

CZ 75 - 9x19 L=153 MM (6")

Order No. Artikelnr.	From Von	Inner Profile Innenprofil	To Zu	Length Länge	Price Preis
Z01-P919-153	9x19	Polygonal	9x19	153 MM	P
Z01-H919-153	9x19	Hexagonal	9x19	153 MM	P
Z01-P921-153	9x19	Polygonal	9x21	153 MM	P
Z01-H919-153	9x19	Hexagonal	9x21	153 MM	P

CZ 75 - 9x19 L=191 MM (7.5")

Order No. Artikelnr.	From Von	Inner Profile Innenprofil	To Zu	Length Länge	Price Preis
Z01-P919-191	9x19	Polygonal	9x19	191 MM	Q
Z01-H919-191	9x19	Hexagonal	9x19	191 MM	Q
Z01-P921-191	9x19	Polygonal	9x21	191 MM	Q
Z01-H919-191	9x19	Hexagonal	9x21	191 MM	Q

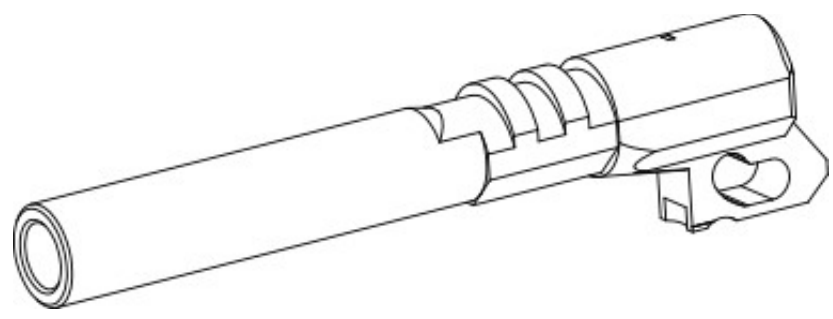

Add Custom Surface Oberflächenoptionen		Price / Preis
PVD (Gold, Silver, Tan, Bronze, ...)	Base + A05	
Sandblast / Sandgestrahlt	Base +A04	
Twisted Fluted / Spiralgefütet	Base +A02	
Straight Fluted / Geradegefütet	Base +A02	

IGB BARRELS FOR CZ



Polygonal vs Hexagonal

Polygonal is very smooth inside and therefore very gastight for high velocity.
 Polygonal ist formbedingt sehr Gasdicht für hohe Geschwindigkeiten.

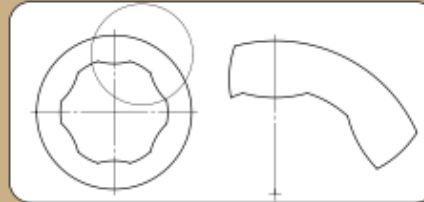
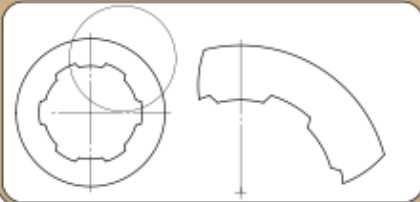

Hexagonal is the more classic approach and also well suited for pure lead.

Hexagonal ist der klassischere Ansatz und gut geeignet für reine Bleigeschoße.

CZ 75 - 9x19 Threaded / Gewinde L=134 MM (5.3")

Caliber Kaliber	Profile Profil	Threading Gewinde	Order No. Artikelnr.	Threading Gewinde	Order No. Artikelnr.	Price Preis
9x19	Poly	1/2x28	Z01-P919-134-G01	M13x1	Z01-P919-134-G02	G+A01
9x19	Hexa	1/2x28	Z01-H919-134-G01	M13x1	Z01-H919-134-G02	G+A01
9x21	Poly	1/2x28	Z01-P921-134-G01	M13x1	Z01-P921-134-G02	G+A01
9x21	Hexa	1/2x28	Z01-H919-134-G01	M13x1	Z01-H919-134-G02	G+A01

More threadings on request / Mehr Gewinde auf Anfrage

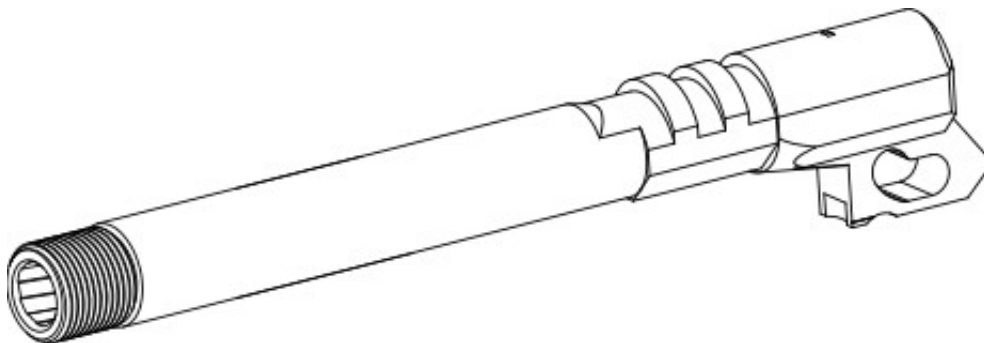

Accessories / Zubehör

	Price / Preis
Model Shark	A09
Model Shark Compact	A09
Steel Thread Protector	A08

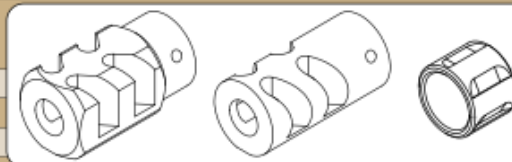

IGB BARRELS FOR CZ

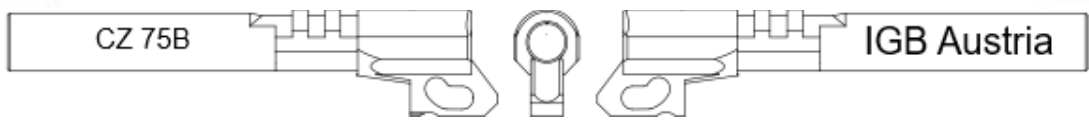

CZ 75B - 9x19

CZ 75B - 9x19 Standard Length (120 MM)

Order No. Artikelnr.	From Von	Inner Profile Innenprofil	To Zu	Length Länge	Price Preis
Z00-P919-S120	9x19	Polygonal	9x19	120 MM	G
Z00-H919-S120	9x19	Hexagonal	9x19	120 MM	G
Z00-P921-S120	9x19	Polygonal	9x21	120 MM	G
Z00-H919-S120	9x19	Hexagonal	9x21	120 MM	G



CZ 75B - 9x19 L=153 MM (6")

Order No. Artikelnr.	From Von	Inner Profile Innenprofil	To Zu	Length Länge	Price Preis
Z00-P919-153	9x19	Polygonal	9x19	153 MM	P
Z00-H919-153	9x19	Hexagonal	9x19	153 MM	P
Z00-P921-153	9x19	Polygonal	9x21	153 MM	P
Z00-H919-153	9x19	Hexagonal	9x21	153 MM	P

CZ 75B - 9x19 L=191 MM (7.5")

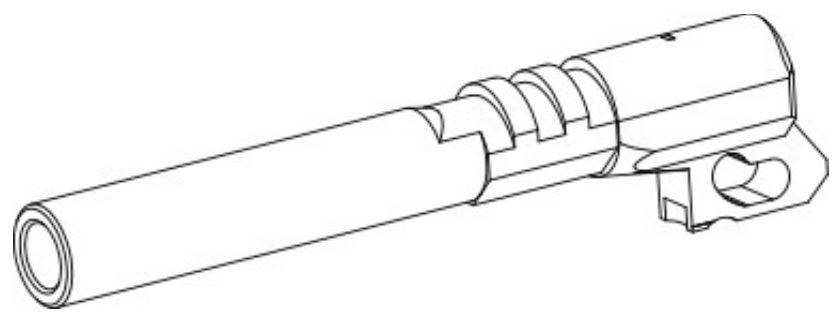
Order No. Artikelnr.	From Von	Inner Profile Innenprofil	To Zu	Length Länge	Price Preis
Z00-P919-191	9x19	Polygonal	9x19	191 MM	Q
Z00-H919-191	9x19	Hexagonal	9x19	191 MM	Q
Z00-P921-191	9x19	Polygonal	9x21	191 MM	Q
Z00-H919-191	9x19	Hexagonal	9x21	191 MM	Q



Add Custom Surface Oberflächenoptionen		Price / Preis
PVD (Gold, Silver, Tan, Bronze, ...)	Base + A05	
Sandblast / Sandgestrahlt	Base +A04	
Twisted Fluted / Spiralgefütet	Base +A02	
Straight Fluted / Geradegefütet	Base +A02	

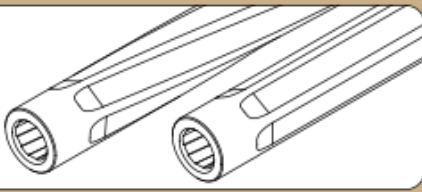

IGB BARRELS FOR CZ



Polygonal vs Hexagonal

Polygonal is very smooth inside and therefore very gastight for high velocity.
 Polygonal ist formbedingt sehr Gasdicht für hohe Geschwindigkeiten.

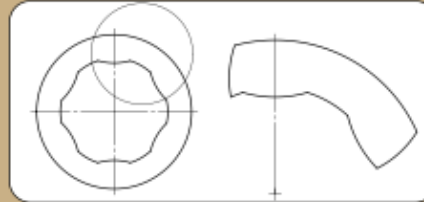
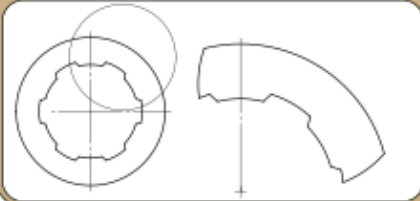

Hexagonal is the more classic approach and also well suited for pure lead.

Hexagonal ist der klassischere Ansatz und gut geeignet für reine Bleigeschoße.

CZ 75B - 9x19 Threaded / Gewinde L=134 MM (5.3")

Caliber Kaliber	Profile Profil	Threading Gewinde	Order No. Artikelnr.	Threading Gewinde	Order No. Artikelnr.	Price Preis
9x19	Poly	1/2x28	Z00-P919-134-G01	M13x1	Z00-P919-134-G02	G+A01
9x19	Hexa	1/2x28	Z00-H919-134-G01	M13x1	Z00-H919-134-G02	G+A01
9x21	Poly	1/2x28	Z00-P921-134-G01	M13x1	Z00-P921-134-G02	G+A01
9x21	Hexa	1/2x28	Z00-H919-134-G01	M13x1	Z00-H919-134-G02	G+A01

More threadings on request / Mehr Gewinde auf Anfrage

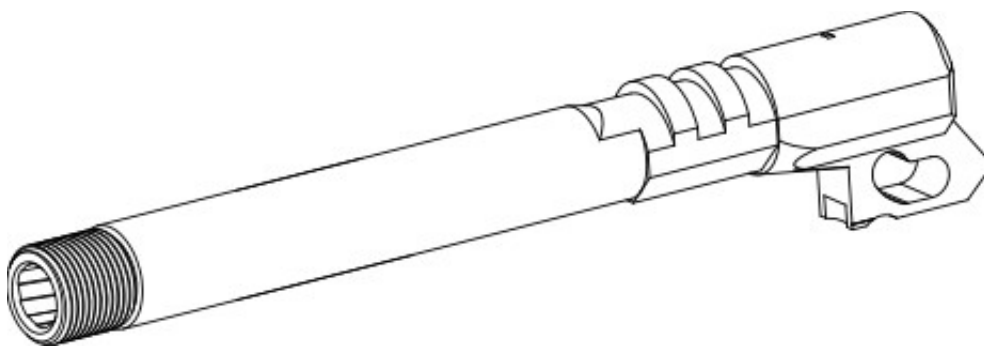

Accessories / Zubehör

	Price / Preis
Model Shark	A09
Model Shark Compact	A09
Steel Thread Protector	A08

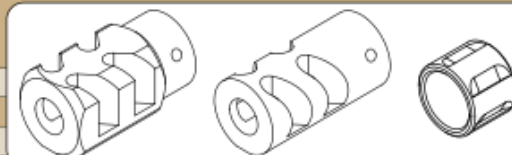

IGB BARRELS FOR CZ

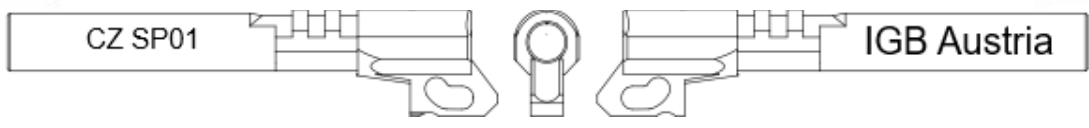

CZ SP01 - 9x19

CZ SP01 - 9x19 Standard Length (120 MM)

Order No. Artikelnr.	From Von	Inner Profile Innenprofil	To Zu	Length Länge	Price Preis
Z05-P919-S120	9x19	Polygonal	9x19	120 MM	G
Z05-H919-S120	9x19	Hexagonal	9x19	120 MM	G
Z05-P921-S120	9x19	Polygonal	9x21	120 MM	G
Z05-H919-S120	9x19	Hexagonal	9x21	120 MM	G

CZ SP01 - 9x19 L=153 MM (6")

Order No. Artikelnr.	From Von	Inner Profile Innenprofil	To Zu	Length Länge	Price Preis
Z05-P919-153	9x19	Polygonal	9x19	153 MM	P
Z05-H919-153	9x19	Hexagonal	9x19	153 MM	P
Z05-P921-153	9x19	Polygonal	9x21	153 MM	P
Z05-H919-153	9x19	Hexagonal	9x21	153 MM	P

CZ SP01 - 9x19 L=191 MM (7.5")

Order No. Artikelnr.	From Von	Inner Profile Innenprofil	To Zu	Length Länge	Price Preis
Z05-P919-191	9x19	Polygonal	9x19	191 MM	Q
Z05-H919-191	9x19	Hexagonal	9x19	191 MM	Q
Z05-P921-191	9x19	Polygonal	9x21	191 MM	Q
Z05-H919-191	9x19	Hexagonal	9x21	191 MM	Q

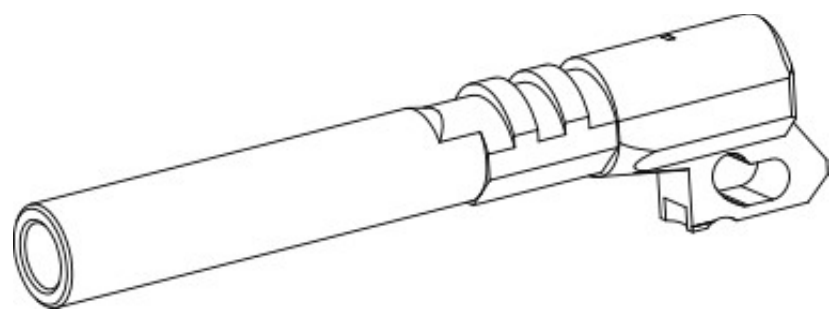

Additional Options / Zusätzliche Optionen	Price / Preis
Straight Fluted / Geradegeflutet	Base +A03
Twisted Fluted / Spiralgeflutet	Base +A03
3 Muzzleports / 3 Mündungsschlitze	Base +A02
5 Muzzleports / 5 Mündungsschlitze	Base +A02

IGB BARRELS FOR CZ



CZ SP01 - 9x19 Threaded / Gewinde L=134 MM (5.3")

Caliber Kaliber	Profile Profil	Threading Gewinde	Order No. Artikelnr.	Threading Gewinde	Order No. Artikelnr.	Price Preis
9x19	Poly	1/2x28	Z05-P919-134-G01	13,5x1L	Z05-P919-134-G04	G+A01
9x19	Hexa	1/2x28	Z05-H919-134-G01	13,5x1L	Z05-H919-134-G04	G+A01
9x21	Poly	1/2x28	Z05-P921-134-G01	13,5x1L	Z05-P921-134-G04	G+A01
9x21	Hexa	1/2x28	Z05-H919-134-G01	13,5x1L	Z05-H919-134-G04	G+A01

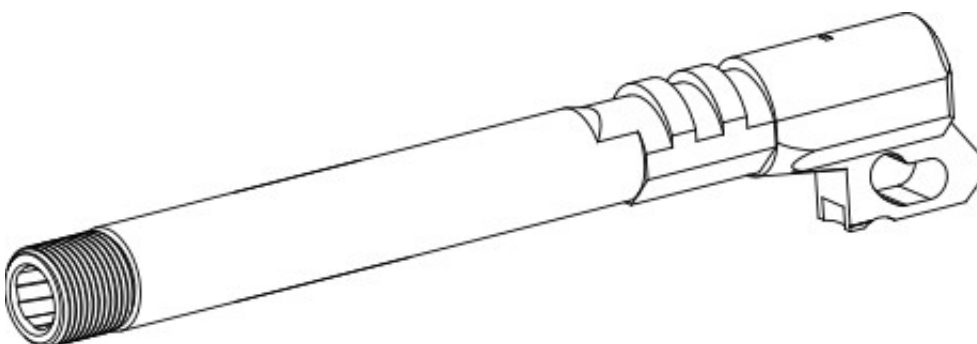

CZ SP01 - 9x19 Threaded / Gewinde L=134 MM (5.3")

Caliber Kaliber	Profile Profil	Threading Gewinde	Order No. Artikelnr.	Threading Gewinde	Order No. Artikelnr.	Price Preis
9x19	Poly	M13x1	Z05-P919-134-G02	M14x1	Z05-P919-134-G05	G+A01
9x19	Hexa	M13x1	Z05-H919-134-G02	M14x1	Z05-H919-134-G05	G+A01
9x21	Poly	M13x1	Z05-P921-134-G02	M14x1	Z05-P921-134-G05	G+A01
9x21	Hexa	M13x1	Z05-H919-134-G02	M14x1	Z05-H919-134-G05	G+A01

More threadings on request / Mehr Gewinde auf Anfrage

Accessories / Zubehör

	Price / Preis
Model Shark	A09
Model Shark Compact	A09
Steel Thread Protector	A08

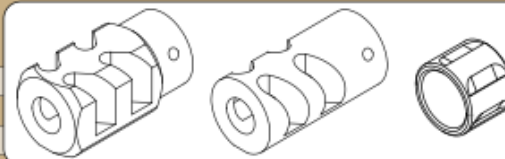

Add Custom Surface Oberflächenoptionen

	Price / Preis
PVD (Gold, Silver, Tan, Bronze, ...)	Base + A05
Sandblast / Sandgestrahlt	Base +A04
Twisted Fluted / Spiralgefütet	Base +A02
Straight Fluted / Geradegefütet	Base +A02

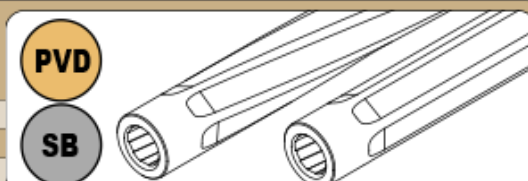

IGB BARRELS FOR CZ

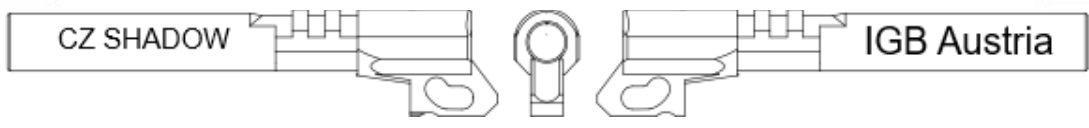

CZ SHADOW 1 & 2 - 9x19

CZ SHADOW 1 & 2 - 9x19 Standard Length (125 MM)

Order No. Artikelnr.	From Von	Inner Profile Innenprofil	To Zu	Length Länge	Price Preis
Z07-P919-S125	9x19	Polygonal	9x19	125 MM	G
Z07-H919-S125	9x19	Hexagonal	9x19	125 MM	G
Z07-P921-S125	9x19	Polygonal	9x21	125 MM	G
Z07-H919-S125	9x19	Hexagonal	9x21	125 MM	G

CZ SHADOW 1 & 2 - 9x19 L=153 MM (6")

Order No. Artikelnr.	From Von	Inner Profile Innenprofil	To Zu	Length Länge	Price Preis
Z07-P919-153	9x19	Polygonal	9x19	153 MM	P
Z07-H919-153	9x19	Hexagonal	9x19	153 MM	P
Z07-P921-153	9x19	Polygonal	9x21	153 MM	P
Z07-H919-153	9x19	Hexagonal	9x21	153 MM	P

CZ SHADOW 1 & 2 - 9x19 L=191 MM (7.5")

Order No. Artikelnr.	From Von	Inner Profile Innenprofil	To Zu	Length Länge	Price Preis
Z07-P919-191	9x19	Polygonal	9x19	191 MM	Q
Z07-H919-191	9x19	Hexagonal	9x19	191 MM	Q
Z07-P921-191	9x19	Polygonal	9x21	191 MM	Q
Z07-H919-191	9x19	Hexagonal	9x21	191 MM	Q

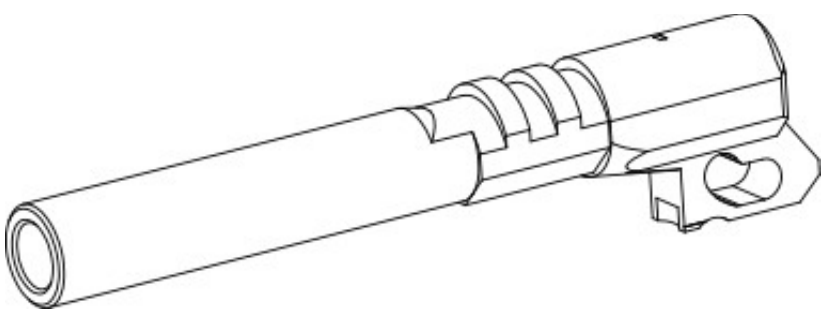

Additional Options / Zusätzliche Optionen	Price / Preis
Straight Fluted / Geradegeflutet	Base +A03
Twisted Fluted / Spiralgeflutet	Base +A03
3 Muzzleports / 3 Mündungsschlitze	Base +A02
5 Muzzleports / 5 Mündungsschlitze	Base +A02

IGB BARRELS FOR CZ



CZ SHADOW 1 & 2 - 9x19 Threaded / Gewinde L=139 MM (5.5")

Caliber Kaliber	Profile Profil	Threading Gewinde	Order No. Artikelnr.	Threading Gewinde	Order No. Artikelnr.	Price Preis
9x19	Poly	1/2x28	Z07-P919-139-G01	13,5x1L	Z07-P919-139-G04	G+A01
9x19	Hexa	1/2x28	Z07-H919-139-G01	13,5x1L	Z07-H919-139-G04	G+A01
9x21	Poly	1/2x28	Z07-P921-139-G01	13,5x1L	Z07-P921-139-G04	G+A01
9x21	Hexa	1/2x28	Z07-H919-139-G01	13,5x1L	Z07-H919-139-G04	G+A01

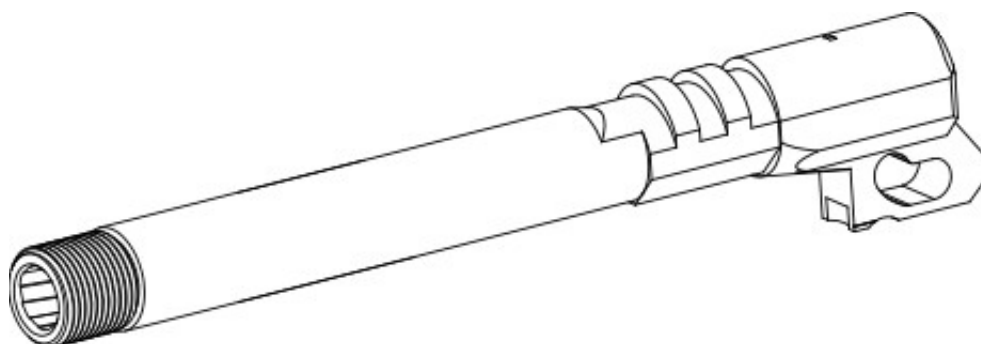

CZ SHADOW 1 & 2 - 9x19 Threaded / Gewinde L=139 MM (5.5")

Caliber Kaliber	Profile Profil	Threading Gewinde	Order No. Artikelnr.	Threading Gewinde	Order No. Artikelnr.	Price Preis
9x19	Poly	M13x1	Z07-P919-139-G02	M14x1	Z07-P919-139-G05	G+A01
9x19	Hexa	M13x1	Z07-H919-139-G02	M14x1	Z07-H919-139-G05	G+A01
9x21	Poly	M13x1	Z07-P921-139-G02	M14x1	Z07-P921-139-G05	G+A01
9x21	Hexa	M13x1	Z07-H919-139-G02	M14x1	Z07-H919-139-G05	G+A01

More threadings on request / Mehr Gewinde auf Anfrage

Accessories / Zubehör

	Price / Preis
Model Shark	A09
Model Shark Compact	A09
Steel Thread Protector	A08

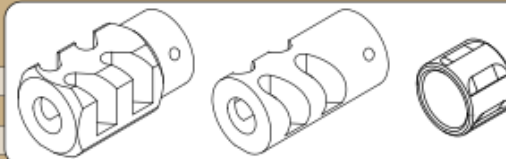

Add Custom Surface Oberflächenoptionen

	Price / Preis
PVD (Gold, Silver, Tan, Bronze, ...)	Base + A05
Sandblast / Sandgestrahlt	Base + A04
Twisted Fluted / Spiralgefütet	Base + A02
Straight Fluted / Geradegefütet	Base + A02

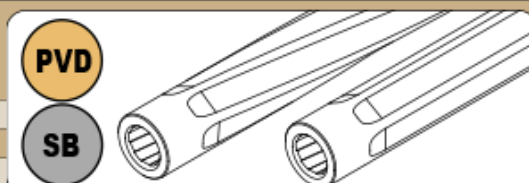

IGB BARRELS FOR CZ

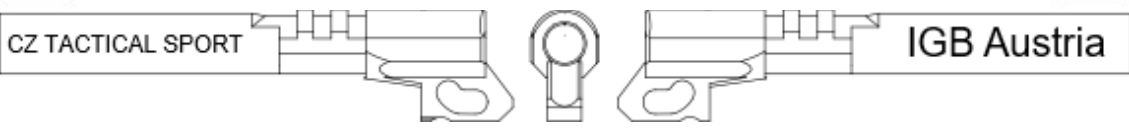

CZ Tactical Sport - 9x19

CZ Tactical Sport - 9x19 Standard Length (137 MM)

Order No. Artikelnr.	From Von	Inner Profile Innenprofil	To Zu	Length Länge	Price Preis
Z02-P919-S137	9x19	Polygonal	9x19	137 MM	G
Z02-H919-S137	9x19	Hexagonal	9x19	137 MM	G
Z02-P921-S137	9x19	Polygonal	9x21	137 MM	G
Z02-H919-S137	9x19	Hexagonal	9x21	137 MM	G

CZ Tactical Sport - 9x19 L=153 MM (6")

Order No. Artikelnr.	From Von	Inner Profile Innenprofil	To Zu	Length Länge	Price Preis
Z02-P919-153	9x19	Polygonal	9x19	153 MM	P
Z02-H919-153	9x19	Hexagonal	9x19	153 MM	P
Z02-P921-153	9x19	Polygonal	9x21	153 MM	P
Z02-H919-153	9x19	Hexagonal	9x21	153 MM	P

CZ Tactical Sport - 9x19 L=191 MM (7.5")

Order No. Artikelnr.	From Von	Inner Profile Innenprofil	To Zu	Length Länge	Price Preis
Z02-P919-191	9x19	Polygonal	9x19	191 MM	Q
Z02-H919-191	9x19	Hexagonal	9x19	191 MM	Q
Z02-P921-191	9x19	Polygonal	9x21	191 MM	Q
Z02-H919-191	9x19	Hexagonal	9x21	191 MM	Q

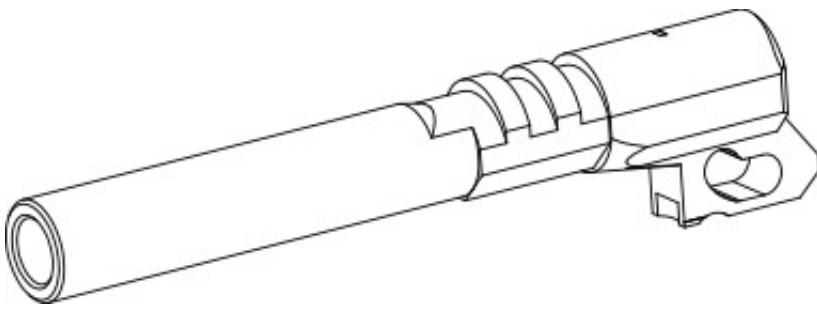

Additional Options / Zusätzliche Optionen	Price / Preis
Straight Fluted / Geradegeflutet	Base +A03
Twisted Fluted / Spiralgeflutet	Base +A03
3 Muzzleports / 3 Mündungsschlitze	Base +A02
5 Muzzleports / 5 Mündungsschlitze	Base +A02

IGB BARRELS FOR CZ

CZ TACTICAL SPORT



IGB Austria

CZ Tactical Sport - 9x19 Threaded / Gewinde L=151 MM (5.9“)

Caliber Kaliber	Profile Profil	Threading Gewinde	Order No. Artikelnr.	Threading Gewinde	Order No. Artikelnr.	Price Preis
9x19	Poly	1/2x28	Z02-P919-151-G01	13,5x1L	Z02-P919-151-G04	G+A01
9x19	Hexa	1/2x28	Z02-H919-151-G01	13,5x1L	Z02-H919-151-G04	G+A01
9x21	Poly	1/2x28	Z02-P921-151-G01	13,5x1L	Z02-P921-151-G04	G+A01
9x21	Hexa	1/2x28	Z02-H919-151-G01	13,5x1L	Z02-H919-151-G04	G+A01

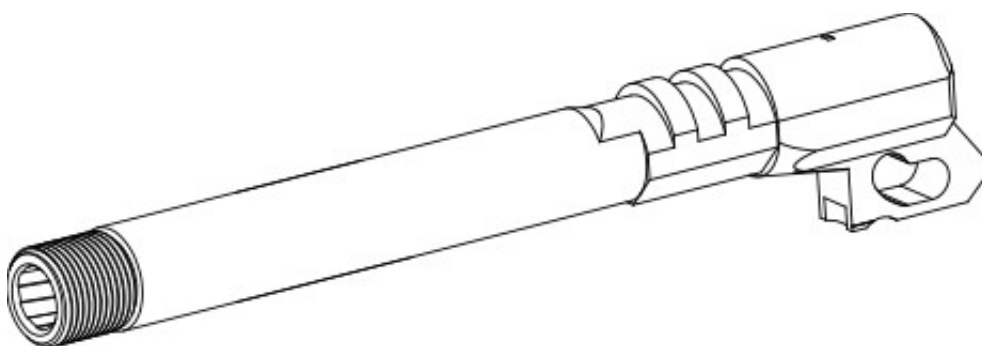

CZ Tactical Sport - 9x19 Threaded / Gewinde L=151 MM (5.9“)

Caliber Kaliber	Profile Profil	Threading Gewinde	Order No. Artikelnr.	Threading Gewinde	Order No. Artikelnr.	Price Preis
9x19	Poly	M13x1	Z02-P919-151-G02	M14x1	Z02-P919-151-G05	G+A01
9x19	Hexa	M13x1	Z02-H919-151-G02	M14x1	Z02-H919-151-G05	G+A01
9x21	Poly	M13x1	Z02-P921-151-G02	M14x1	Z02-P921-151-G05	G+A01
9x21	Hexa	M13x1	Z02-H919-151-G02	M14x1	Z02-H919-151-G05	G+A01

More threadings on request / Mehr Gewinde auf Anfrage

Accessories / Zubehör

	Price / Preis
Model Shark	A09
Model Shark Compact	A09
Steel Thread Protector	A08

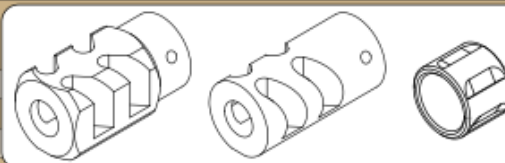

Add Custom Surface Oberflächenoptionen

	Price / Preis
PVD (Gold, Silver, Tan, Bronze, ...)	Base + A05
Sandblast / Sandgestrahlt	Base + A04
Twisted Fluted / Spiralgefütet	Base + A02
Straight Fluted / Geradegefütet	Base + A02

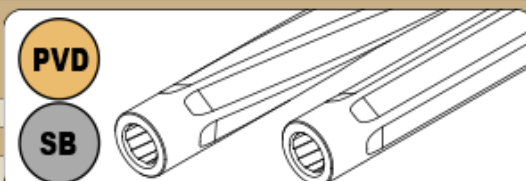

IGB BARRELS FOR CZ

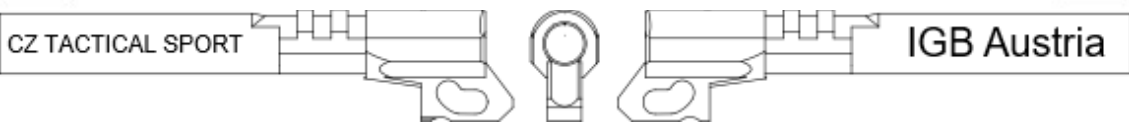

CZ Tactical Sport - .40 S&W

CZ Tactical Sport – 40 S&W Standard Length (137 MM)

Order No. Artikelnr.	From Von	Inner Profile Innenprofil	To Zu	Length Länge	Price Preis
Z09-H040-S137	40 S&W	Hexagonal	40 S&W	137 MM	G
Z09-H357-S137	40 S&W	Hexagonal	.357 Sig	137 MM	G
Z09-P357-S137	40 S&W	Polygonal	.357 Sig	137 MM	G

CZ Tactical Sport - 40 S&W L=153 MM (6“)

Order No. Artikelnr.	From Von	Inner Profile Innenprofil	To Zu	Length Länge	Price Preis
Z09-H040-153	40 S&W	Hexagonal	40 S&W	153 MM	P
Z09-H357-153	40 S&W	Hexagonal	.357 Sig	153 MM	P
Z09-P357-153	40 S&W	Polygonal	.357 Sig	153 MM	P

CZ Tactical Sport - 40 S&W L=191 MM (7.5“)

Order No. Artikelnr.	From Von	Inner Profile Innenprofil	To Zu	Length Länge	Price Preis
Z09-H040-191	40 S&W	Hexagonal	40 S&W	191 MM	Q
Z09-H357-191	40 S&W	Hexagonal	.357 Sig	191 MM	Q
Z09-P357-191	40 S&W	Polygonal	.357 Sig	191 MM	Q

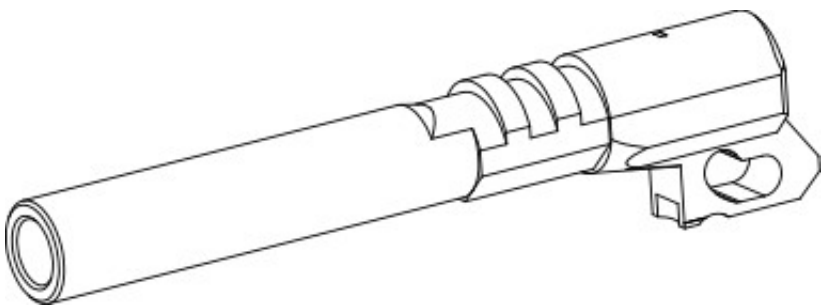

Additional Options / Zusätzliche Optionen	Price / Preis
Straight Fluted / Geradegeflutet	Base +A03
Twisted Fluted / Spiralgeflutet	Base +A03
3 Muzzleports / 3 Mündungsschlitze	Base +A02
5 Muzzleports / 5 Mündungsschlitze	Base +A02

IGB BARRELS FOR CZ

CZ TACTICAL SPORT



IGB Austria

CZ Tactical Sport - 40 S&W Threaded / Gewinde L=151 MM (5.9")

Caliber Kaliber	Profile Profil	Threading Gewinde	Order No. Artikelnr.	Threading Gewinde	Order No. Artikelnr.	Price Preis
9x19	Poly	1/2x28	Z09-H040-151-G01	13,5x1L	Z09-H040-151-G04	G+A01
9x19	Hexa	1/2x28	Z09-H357-151-G01	13,5x1L	Z09-H357-151-G04	G+A01
9x21	Poly	1/2x28	Z09-P357-151-G01	13,5x1L	Z09-P357-151-G04	G+A01

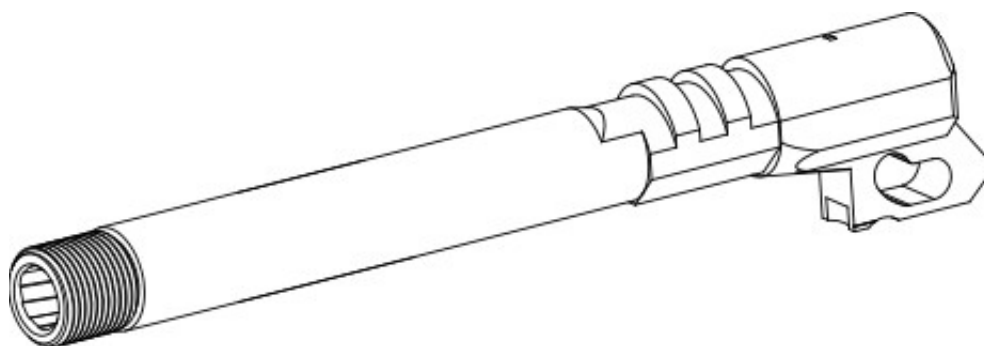

CZ Tactical Sport - 40 S&W Threaded / Gewinde L=151 MM (5.9")

Caliber Kaliber	Profile Profil	Threading Gewinde	Order No. Artikelnr.	Threading Gewinde	Order No. Artikelnr.	Price Preis
9x19	Poly	M13x1	Z09-H040-151-G02	M14x1	Z09-H040-151-G05	G+A01
9x19	Hexa	M13x1	Z09-H357-151-G02	M14x1	Z09-H357-151-G05	G+A01
9x21	Poly	M13x1	Z09-P357-151-G02	M14x1	Z09-P357-151-G05	G+A01

More threadings on request / Mehr Gewinde auf Anfrage

Accessories / Zubehör

	Price / Preis
Model Shark	A09
Model Shark Compact	A09
Steel Thread Protector	A08

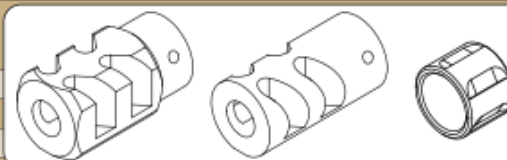

Add Custom Surface Oberflächenoptionen

	Price / Preis
PVD (Gold, Silver, Tan, Bronze, ...)	Base + A05
Sandblast / Sandgestrahlt	Base +A04
Twisted Fluted / Spiralgefütet	Base +A02
Straight Fluted / Geradegefütet	Base +A02

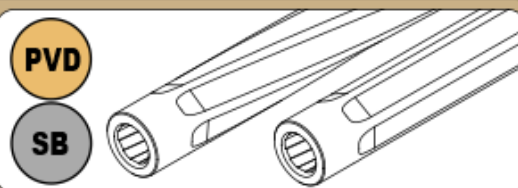

IGB BARRELS FOR CZ

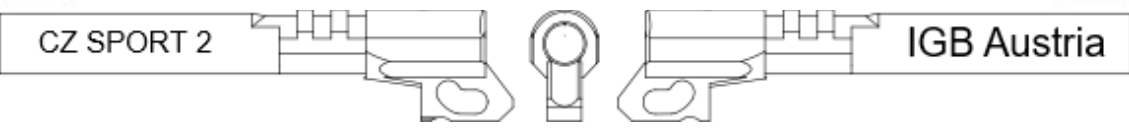

CZ Sport 2 - 9x19

CZ Sport 2 - 9x19 Standard Length (153MM)

Order No. Artikelnr.	From Von	Inner Profile Innenprofil	To Zu	Length Länge	Price Preis
Z12-P919-S153	9x19	Polygonal	9x19	153 MM	P
Z12-H919-S153	9x19	Hexagonal	9x19	153 MM	P
Z12-P921-S153	9x19	Polygonal	9x21	153 MM	P
Z12-H919-S153	9x19	Hexagonal	9x21	153 MM	P

CZ Sport 2 - 9x19 L=191 MM (7.5")

Order No. Artikelnr.	From Von	Inner Profile Innenprofil	To Zu	Length Länge	Price Preis
Z12-P919-191	9x19	Polygonal	9x19	191 MM	Q
Z12-H919-191	9x19	Hexagonal	9x19	191 MM	Q
Z12-P921-191	9x19	Polygonal	9x21	191 MM	Q
Z12-H919-191	9x19	Hexagonal	9x21	191 MM	Q

CZ Sport 2 - 9x19 Threaded / Gewinde L=167 MM (6.6")

Caliber Kaliber	Profile Profil	Threading Gewinde	Order No. Artikelnr.	Threading Gewinde	Order No. Artikelnr.	Price Preis
9x19	Poly	1/2x28	Z12-P919-167-G01	M13x1	Z12-P919-167-G02	G+A01
9x19	Hexa	1/2x28	Z12-H919-167-G01	M13x1	Z12-H919-167-G02	G+A01
9x21	Poly	1/2x28	Z12-P921-167-G01	M13x1	Z12-P921-167-G02	G+A01
9x21	Hexa	1/2x28	Z12-H919-167-G01	M13x1	Z12-H919-167-G02	G+A01

**Add Custom Surface
Oberflächenoptionen**

	Price / Preis
PVD (Gold, Silver, Tan, Bronze, ...)	Base + A05
Sandblast / Sandgestrahlt	Base +A04
Twisted Fluted / Spiralgefütet	Base +A02
Straight Fluted / Geradegefütet	Base +A02

Accessories / Zubehör

	Price / Preis
Model Shark	A09
Model Shark Compact	A09
Steel Thread Protector	A08

IGB BARRELS FOR CZ

CZ VIPER / MAMBA



IGB Austria

CZ Viper & Mamba - 9x19

CZ Viper & Mamba - 9x19 Standard Length (153MM)

Order No. Artikelnr.	From Von	Inner Profile Innenprofil	To Zu	Length Länge	Price Preis
Z12-P919-S153	9x19	Polygonal	9x19	153 MM	P
Z12-H919-S153	9x19	Hexagonal	9x19	153 MM	P
Z12-P921-S153	9x19	Polygonal	9x21	153 MM	P
Z12-H919-S153	9x19	Hexagonal	9x21	153 MM	P

CZ Viper & Mamba- 9x19 L=191 MM (7.5")

Order No. Artikelnr.	From Von	Inner Profile Innenprofil	To Zu	Length Länge	Price Preis
Z12-P919-191	9x19	Polygonal	9x19	191 MM	Q
Z12-H919-191	9x19	Hexagonal	9x19	191 MM	Q
Z12-P921-191	9x19	Polygonal	9x21	191 MM	Q
Z12-H919-191	9x19	Hexagonal	9x21	191 MM	Q

CZ Viper & Mamba - 9x19 Threaded / Gewinde L=167 MM (6.6")

Caliber Kaliber	Profile Profil	Threading Gewinde	Order No. Artikelnr.	Threading Gewinde	Order No. Artikelnr.	Price Preis
9x19	Poly	1/2x28	Z12-P919-167-G01	M13x1	Z12-P919-167-G02	G+A01
9x19	Hexa	1/2x28	Z12-H919-167-G01	M13x1	Z12-H919-167-G02	G+A01
9x21	Poly	1/2x28	Z12-P921-167-G01	M13x1	Z12-P921-167-G02	G+A01
9x21	Hexa	1/2x28	Z12-H919-167-G01	M13x1	Z12-H919-167-G02	G+A01

Add Custom Surface Oberflächenoptionen

PVD (Gold, Silver, Tan, Bronze, ...)

Sandblast / Sandgestrahlt

Twisted Fluted / Spiralgefütet

Straight Fluted / Geradegefütet

Price / Preis

Base + A05

Base +A04

Base +A02

Base +A02

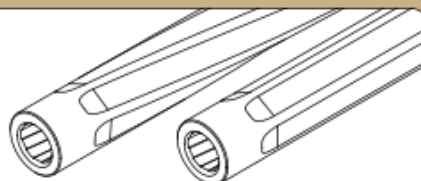

Accessories / Zubehör

Price / Preis

Model Shark

A09

Model Shark Compact

A09

Steel Thread Protector

A08

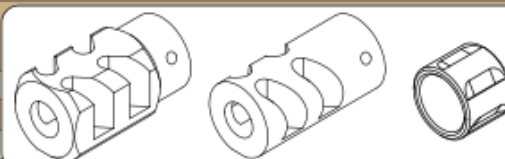

IGB Austria Inh. Viktor Schranz-Gaertnergasse 15-A-2251 Ebenthal

Tel +43 (0) 2538 87378 www.igbaustria.com info@igbaustria.com

103/190

IGB BARRELS FOR CZ

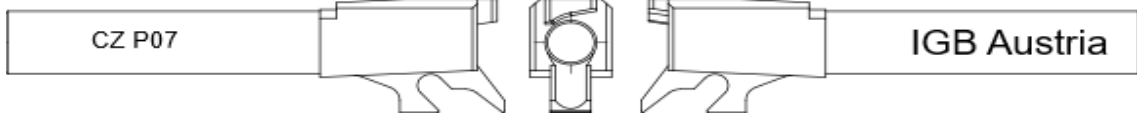

CZ P07 - 9x19

CZ P07 - 9x19 Standard Length (96 MM)

Order No. Artikelnr.	From Von	Inner Profile Innenprofil	To Zu	Length Länge	Price Preis
Z15-P919-S096	9x19	Polygonal	9x19	120 MM	G
Z15-H919-S096	9x19	Hexagonal	9x19	120 MM	G
Z15-P921-S096	9x19	Polygonal	9x21	120 MM	G
Z15-H919-S096	9x19	Hexagonal	9x21	120 MM	G

CZ P07 - 9x19 L=153 MM (6")

Order No. Artikelnr.	From Von	Inner Profile Innenprofil	To Zu	Length Länge	Price Preis
Z15-P919-153	9x19	Polygonal	9x19	153 MM	P
Z15-H919-153	9x19	Hexagonal	9x19	153 MM	P
Z15-P921-153	9x19	Polygonal	9x21	153 MM	P
Z15-H919-153	9x19	Hexagonal	9x21	153 MM	P

CZ P07 - 9x19 L=191 MM (7.5")

Order No. Artikelnr.	From Von	Inner Profile Innenprofil	To Zu	Length Länge	Price Preis
Z15-P919-191	9x19	Polygonal	9x19	191 MM	Q
Z15-H919-191	9x19	Hexagonal	9x19	191 MM	Q
Z15-P921-191	9x19	Polygonal	9x21	191 MM	Q
Z15-H919-191	9x19	Hexagonal	9x21	191 MM	Q

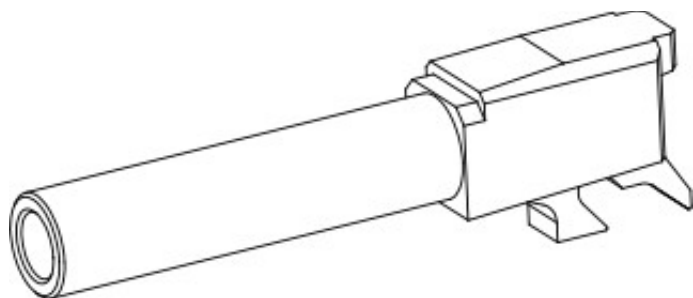

Additional Options / Zusätzliche Optionen	Price / Preis
Straight Fluted / Geradegeflutet	Base +A03
Twisted Fluted / Spiralgeflutet	Base +A03
3 Muzzleports / 3 Mündungsschlitze	Base +A02
5 Muzzleports / 5 Mündungsschlitze	Base +A02

IGB BARRELS FOR CZ

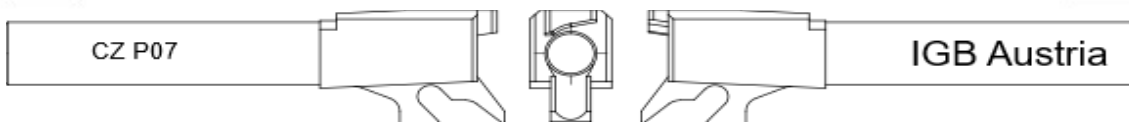

CZ P07 - 9x19 Threaded / Gewinde L=110 MM (4.3")

Caliber Kaliber	Profile Profil	Threading Gewinde	Order No. Artikelnr.	Threading Gewinde	Order No. Artikelnr.	Price Preis
9x19	Poly	1/2x28	Z15-P919-110-G01	13,5x1L	Z15-P919-110-G04	G+A01
9x19	Hexa	1/2x28	Z15-H919-110-G01	13,5x1L	Z15-H919-110-G04	G+A01
9x21	Poly	1/2x28	Z15-P921-110-G01	13,5x1L	Z15-P921-110-G04	G+A01
9x21	Hexa	1/2x28	Z15-H919-110-G01	13,5x1L	Z15-H919-110-G04	G+A01

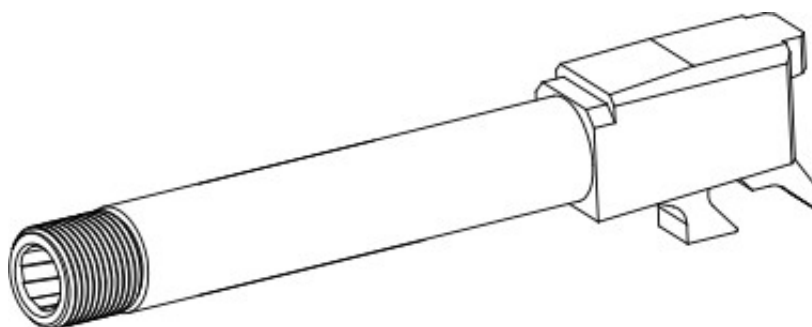

CZ P07 - 9x19 Threaded / Gewinde L=110 MM (4.3")

Caliber Kaliber	Profile Profil	Threading Gewinde	Order No. Artikelnr.	Threading Gewinde	Order No. Artikelnr.	Price Preis
9x19	Poly	M13x1	Z15-P919-110-G02	M14x1	Z15-P919-110-G05	G+A01
9x19	Hexa	M13x1	Z15-H919-110-G02	M14x1	Z15-H919-110-G05	G+A01
9x21	Poly	M13x1	Z15-P921-110-G02	M14x1	Z15-P921-110-G05	G+A01
9x21	Hexa	M13x1	Z15-H919-110-G02	M14x1	Z15-H919-110-G05	G+A01

More threadings on request / Mehr Gewinde auf Anfrage

Accessories / Zubehör

	Price / Preis
Model Shark	A09
Model Shark Compact	A09
Steel Thread Protector	A08

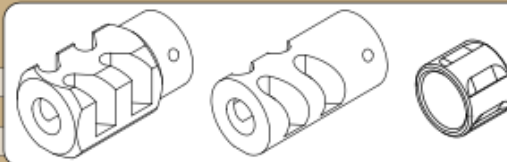

Add Custom Surface Oberflächenoptionen

	Price / Preis
PVD (Gold, Silver, Tan, Bronze, ...)	Base + A05
Sandblast / Sandgestrahlt	Base + A04
Twisted Fluted / Spiralgeflutet	Base + A02
Straight Fluted / Geradegeflutet	Base + A02

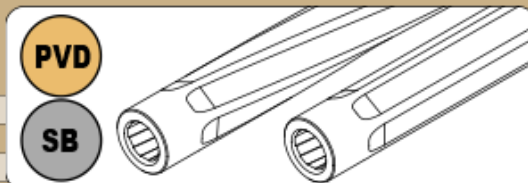

IGB BARRELS IDEAS

Make it YOUR Gun with the IGB Variety
 Machen Sie es zu IHRER Pistole mit den IGB Variationen.

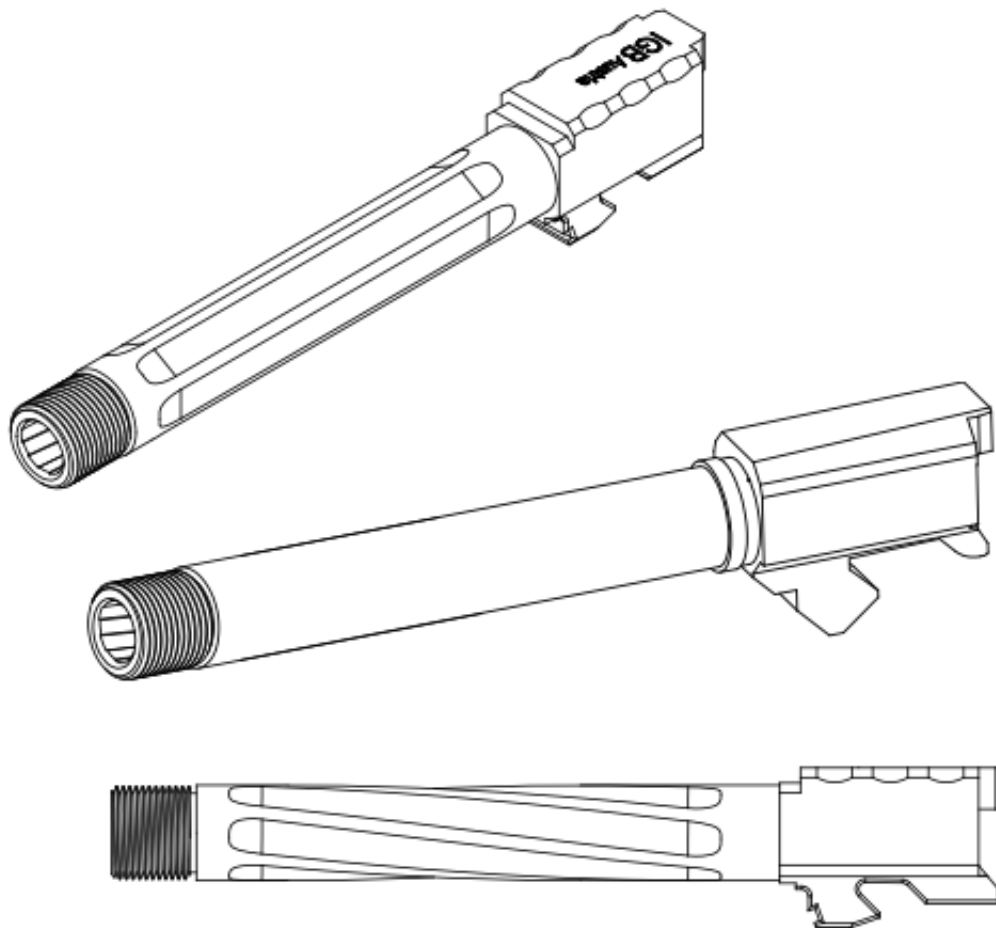

Accessories / Zubehör

	Price / Preis
Model Shark	A09
Model Shark Compact	A09
Steel Thread Protector	A08

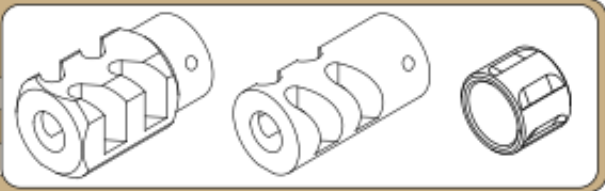

Add Custom Surface Oberflächenoptionen

	Price / Preis
PVD (Gold, Silver, Tan, Bronze, ...)	Base + A05
Sandblast / Sandgestrahlt	Base +A04
Twisted Fluted / Spiralfelutet	Base +A02
Straight Fluted / Geradegefutet	Base +A02

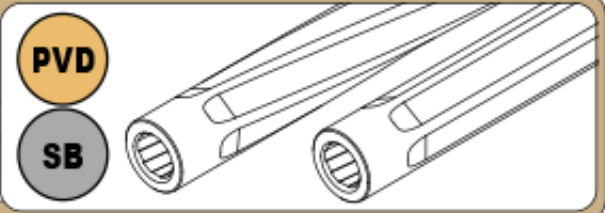

PVD

SB

IGB BARRELS FOR SMITH & WESSON

S&W



IGB Austria

Barreltechnology

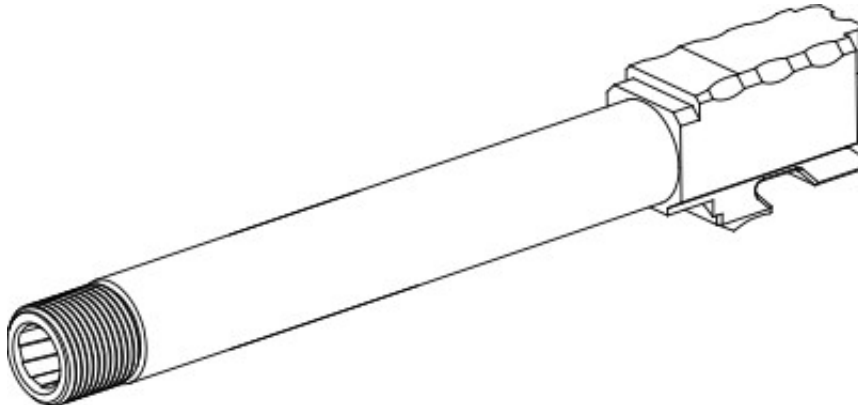
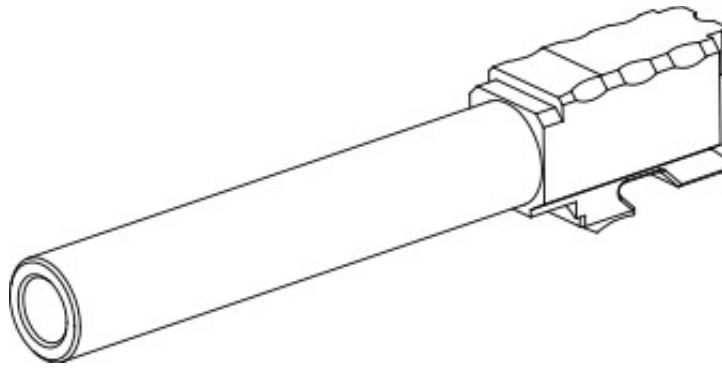

IGB BARRELS FOR SMITH & WESSON



S&W M&P 9 - 9x19

S&W M&P 9 - 9x19 Standard Length (108 MM)

Order No. Artikelnr.	From Von	Inner Profile Innenprofil	To Zu	Length Länge	Price Preis
W9A-P919-S108	9x19	Polygonal	9x19	108 MM	H
W9A-H919-S108	9x19	Hexagonal	9x19	108 MM	H
W9A-P921-S108	9x19	Polygonal	9x21	108 MM	H
W9A-H765-S108	9x19	Hexagonal	7,65 Para	108 MM	H

S&W M&P 9 - 9x19 L=153 MM (6")

Order No. Artikelnr.	From Von	Inner Profile Innenprofil	To Zu	Length Länge	Price Preis
W9A-P919-153	9x19	Polygonal	9x19	153 MM	I
W9A-H919-153	9x19	Hexagonal	9x19	153 MM	I
W9A-P921-153	9x19	Polygonal	9x21	153 MM	I
W9A-H765-153	9x19	Hexagonal	7,65 Para	153 MM	I

S&W M&P 9 - 9x19 L=191 MM (7.5")

Order No. Artikelnr.	From Von	Inner Profile Innenprofil	To Zu	Length Länge	Price Preis
W9A-P919-191	9x19	Polygonal	9x19	191 MM	J
W9A-H919-191	9x19	Hexagonal	9x19	191 MM	J
W9A-P921-191	9x19	Polygonal	9x21	191 MM	J

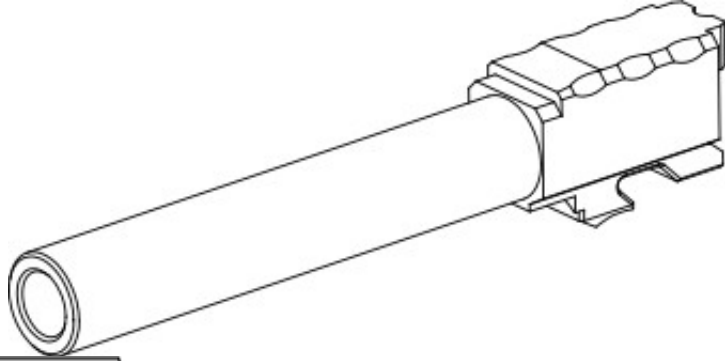

Additional Options / Zusätzliche Optionen	Price / Preis
Straight Fluted / Geradegefütet	Base +A03
Twisted Fluted / Spiralgefütet	Base +A03
3 Muzzleports / 3 Mündungsschlitze	Base +A02
5 Muzzleports / 5 Mündungsschlitze	Base +A02

IGB BARRELS FOR SMITH & WESSON

S&W M&P9

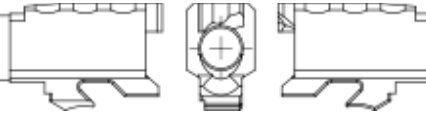

IGB Austria

S&W M&P 9 - 9x19 Threaded / Gewinde L=122 MM (4.8")

Caliber Kaliber	Profile Profil	Threading Gewinde	Order No. Artikelnr.	Threading Gewinde	Order No. Artikelnr.	Price Preis
9x19	Poly	1/2x28	W9A-P919-122-G01	M13,5x1L	W9A-P919-122-G04	H+A01
9x19	Hexa	1/2x28	W9A-H919-122-G01	M13,5x1L	W9A-H919-122-G04	H+A01
9x21	Poly	1/2x28	W9A-P921-122-G01	M13,5x1L	W9A-P921-122-G04	H+A01
7,65 Para	Hexa	1/2x28	W9A-H765-122-G01	M13,5x1L	W9A-H765-122-G04	H+A01

S&W M&P 9 - 9x19 Threaded / Gewinde L=122 MM (4.8")

Caliber Kaliber	Profile Profil	Threading Gewinde	Order No. Artikelnr.	Threading Gewinde	Order No. Artikelnr.	Price Preis
9x19	Poly	M13x1	W9A-P919-122-G02	M14x1	W9A-P919-122-G05	H+A01
9x19	Hexa	M13x1	W9A-H919-122-G02	M14x1	W9A-H919-122-G05	H+A01
9x21	Poly	M13x1	W9A-P921-122-G02	M14x1	W9A-P921-122-G05	H+A01
7,65 Para	Hexa	M13x1	W9A-H765-122-G02	M14x1	W9A-H765-122-G05	H+A01

More threadings on request / Mehr Gewinde auf Anfrage

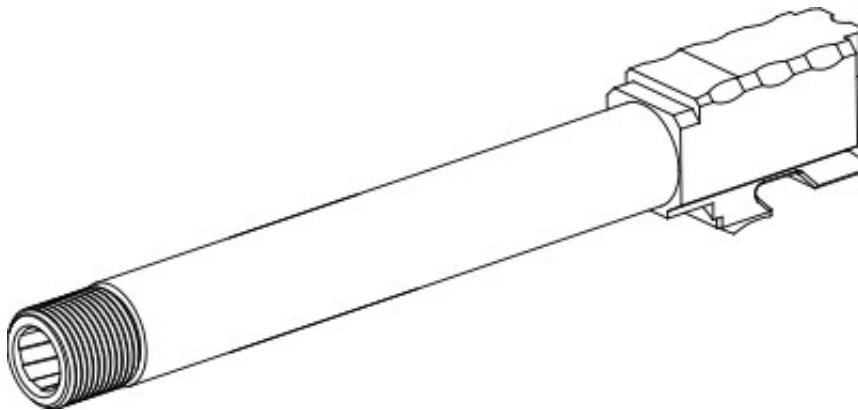

Accessories / Zubehör

	Price / Preis
Model Shark	A09
Model Shark Compact	A09
Steel Thread Protector	A08

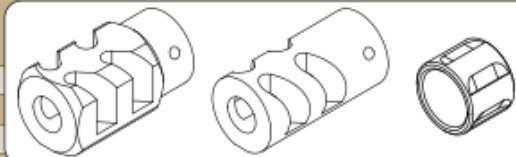

Add Custom Surface Oberflächenoptionen

	Price / Preis
PVD (Gold, Silver, Tan, Bronze, ...)	Base + A05
Sandblast / Sandgestrahlt	Base + A04
Twisted Fluted / Spiralgefütet	Base + A02
Straight Fluted / Geradegefütet	Base + A02

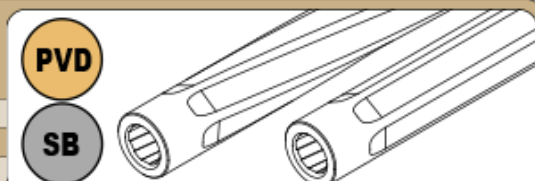

IGB BARRELS FOR SMITH & WESSON



S&W M&P 9 M2.0- 9x19

S&W M&P 9 M2.0 - 9x19 Standard Length (108 MM)

Order No. Artikelnr.	From Von	Inner Profile Innenprofil	To Zu	Length Länge	Price Preis
W9B-P919-S108	9x19	Polygonal	9x19	108 MM	H
W9B-H919-S108	9x19	Hexagonal	9x19	108 MM	H
W9B-P921-S108	9x19	Polygonal	9x21	108 MM	H
W9B-H765-S108	9x19	Hexagonal	7,65 Para	108 MM	H

S&W M&P 9 M2.0 - 9x19 L=153 MM (6")

Order No. Artikelnr.	From Von	Inner Profile Innenprofil	To Zu	Length Länge	Price Preis
W9B-P919-153	9x19	Polygonal	9x19	153 MM	I
W9B-H919-153	9x19	Hexagonal	9x19	153 MM	I
W9B-P921-153	9x19	Polygonal	9x21	153 MM	I
W9B-H765-153	9x19	Hexagonal	7,65 Para	153 MM	I

S&W M&P 9 M2.0 - 9x19 L=191 MM (7.5")

Order No. Artikelnr.	From Von	Inner Profile Innenprofil	To Zu	Length Länge	Price Preis
W9B-P919-191	9x19	Polygonal	9x19	191 MM	J
W9B-H919-191	9x19	Hexagonal	9x19	191 MM	J
W9B-P921-191	9x19	Polygonal	9x21	191 MM	J

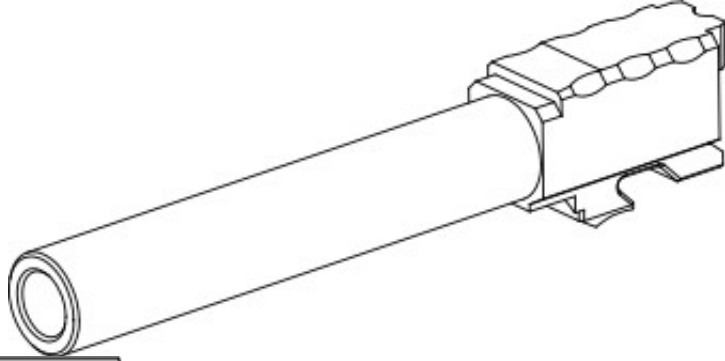

Additional Options / Zusätzliche Optionen	Price / Preis
Straight Fluted / Geradegeflutet	Base +A03
Twisted Fluted / Spiralgeflutet	Base +A03
3 Muzzleports / 3 Mündungsschlitze	Base +A02
5 Muzzleports / 5 Mündungsschlitze	Base +A02

IGB BARRELS FOR SMITH & WESSON

S&W M&P9 M2.0

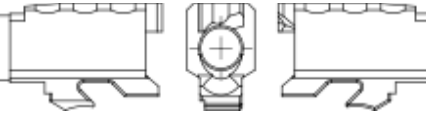

IGB Austria

S&W M&P 9 M2.0 - 9x19 Threaded / Gewinde L=122 MM (4.8")

Caliber Kaliber	Profile Profil	Threading Gewinde	Order No. Artikelnr.	Threading Gewinde	Order No. Artikelnr.	Price Preis
9x19	Poly	1/2x28	W9B-P919-122-G01	M13,5x1L	W9B-P919-122-G04	H+A01
9x19	Hexa	1/2x28	W9B-H919-122-G01	M13,5x1L	W9B-H919-122-G04	H+A01
9x21	Poly	1/2x28	W9B-P921-122-G01	M13,5x1L	W9B-P921-122-G04	H+A01
7,65 Para	Hexa	1/2x28	W9B-H765-122-G01	M13,5x1L	W9B-H765-122-G04	H+A01

S&W M&P 9 M2.0 - 9x19 Threaded / Gewinde L=122 MM (4.8")

Caliber Kaliber	Profile Profil	Threading Gewinde	Order No. Artikelnr.	Threading Gewinde	Order No. Artikelnr.	Price Preis
9x19	Poly	M13x1	W9B-P919-122-G02	M14x1	W9B-P919-122-G05	H+A01
9x19	Hexa	M13x1	W9B-H919-122-G02	M14x1	W9B-H919-122-G05	H+A01
9x21	Poly	M13x1	W9B-P921-122-G02	M14x1	W9B-P921-122-G05	H+A01
7,65 Para	Hexa	M13x1	W9B-H765-122-G02	M14x1	W9B-H765-122-G05	H+A01

More threadings on request / Mehr Gewinde auf Anfrage

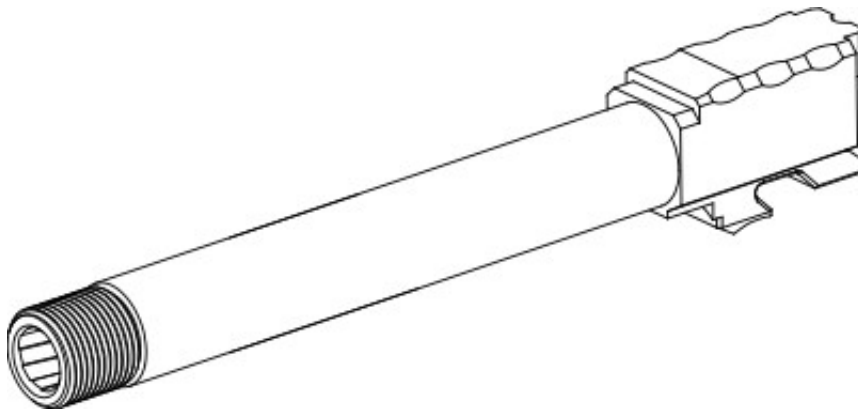

Accessories / Zubehör

	Price / Preis
Model Shark	A09
Model Shark Compact	A09
Steel Thread Protector	A08

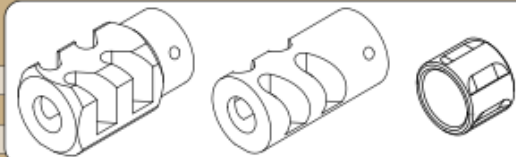

Add Custom Surface Oberflächenoptionen

	Price / Preis
PVD (Gold, Silver, Tan, Bronze, ...)	Base + A05
Sandblast / Sandgestrahlt	Base + A04
Twisted Fluted / Spiralgefütet	Base + A02
Straight Fluted / Geradegefütet	Base + A02

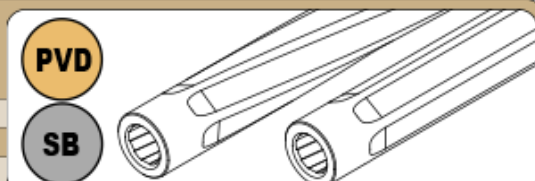

IGB BARRELS IDEAS

Make it YOUR Gun with the IGB Variety
 Machen Sie es zu IHRER Pistole mit den IGB Variationen.

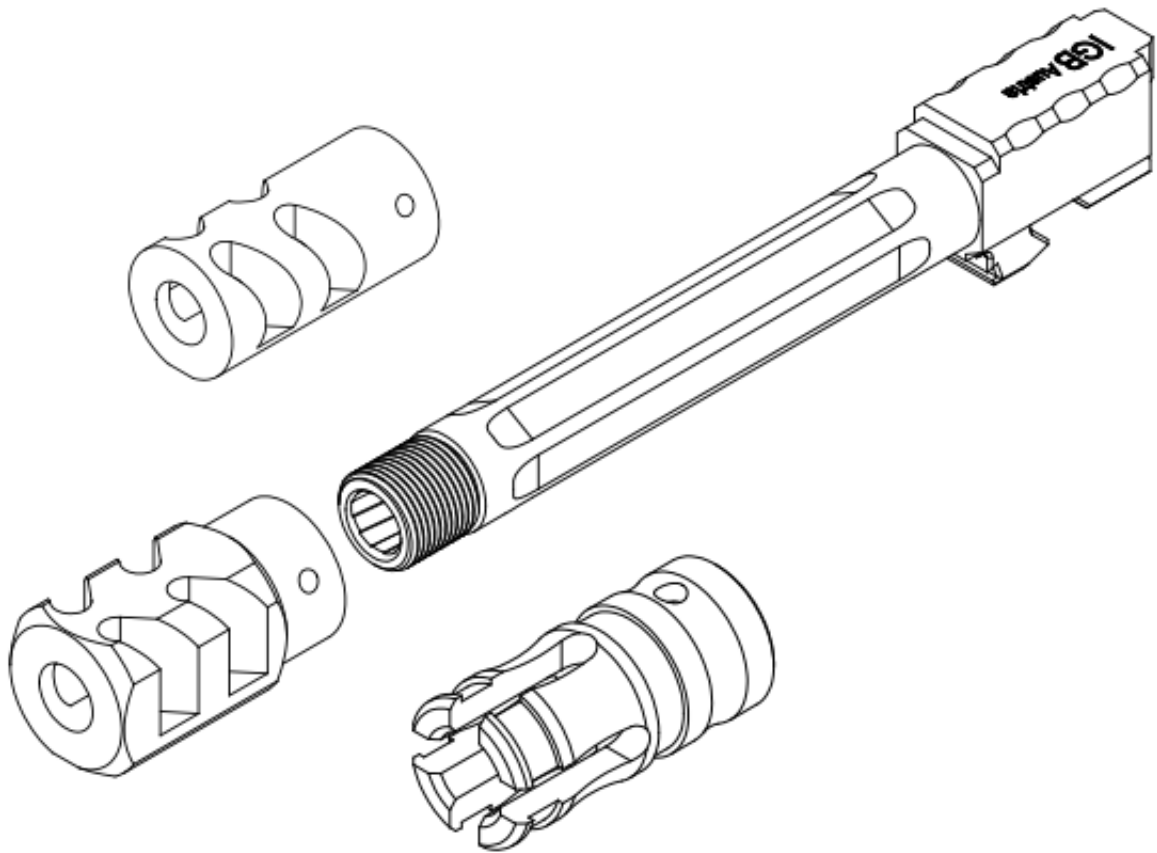

Accessories / Zubehör

	Price / Preis
Model Shark	A09
Model Shark Compact	A09
Steel Thread Protector	A08

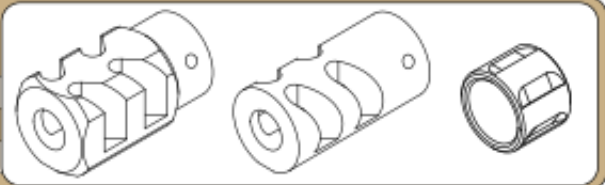

Add Custom Surface Oberflächenoptionen

	Price / Preis
PVD (Gold, Silver, Tan, Bronze, ...)	Base + A05
Sandblast / Sandgestrahlt	Base +A04
Twisted Fluted / Spiralgefütet	Base +A02
Straight Fluted / Geradegefütet	Base +A02

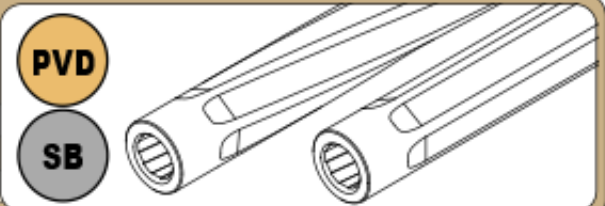

IGB BARRELS FOR SIG SAUER

Sig Sauer



IGB Austria

Barreltechnology

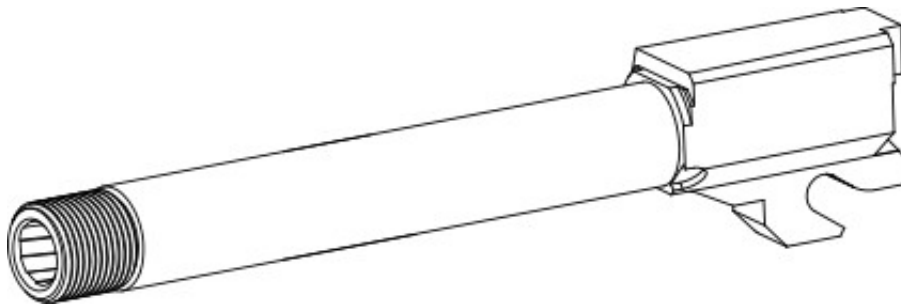
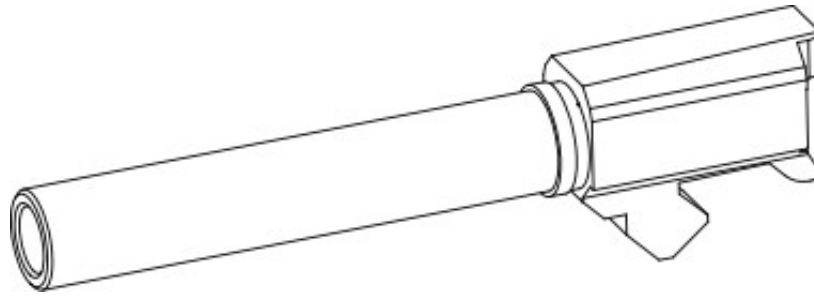

GLOCK AR15 CZ SIG SAUER P210 1911 STEYR H&K OTHER ACCESSORY

ACCESSORY OTHER H&K STEYR 1911 P210 SIG SAUER CZ AR15 GLOCK

IGB BARRELS FOR SIG SAUER

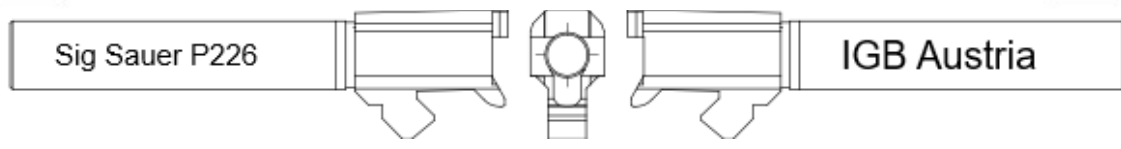

P226 9x19

Sig Sauer P226 9x19 Standard Length (113 MM)

Order No. Artikelnr.	From Von	Inner Profile Innenprofil	To Zu	Length Länge	Price Preis
S03-P919-S113	9x19	Polygonal	9x19	114 MM	G
S03-H919-S113	9x19	Hexagonal	9x19	114 MM	G
S03-P921-S113	9x19	Polygonal	9x21	114 MM	G
S03-H919-S113	9x19	Hexagonal	9x21	114 MM	G
S03-H765-S113	9x19	Hexagonal	7,65 Para*	114 MM	G

*9mm Magazine can be used / 9mm Magazin kann verwendet werden

Sig Sauer P226 9x19 L=153 MM (6")

Order No. Artikelnr.	From Von	Inner Profile Innenprofil	To Zu	Length Länge	Price Preis
S03-P919-153	9x19	Polygonal	9x19	153 MM	P
S03-H919-153	9x19	Hexagonal	9x19	153 MM	P
S03-P921-153	9x19	Polygonal	9x21	153 MM	P
S03-H919-153	9x19	Hexagonal	9x21	153 MM	P

Sig Sauer P226 9x19 L=191 MM (7.5")

Order No. Artikelnr.	From Von	Inner Profile Innenprofil	To Zu	Length Länge	Price Preis
S03-P919-191	9x19	Polygonal	9x19	191 MM	Q
S03-H919-191	9x19	Hexagonal	9x19	191 MM	Q
S03-P921-191	9x19	Polygonal	9x21	191 MM	Q
S03-H919-191	9x19	Hexagonal	9x21	191 MM	Q

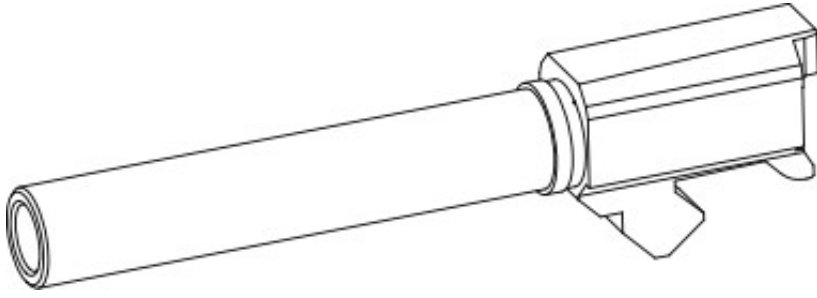

IGB BARRELS FOR SIG SAUER

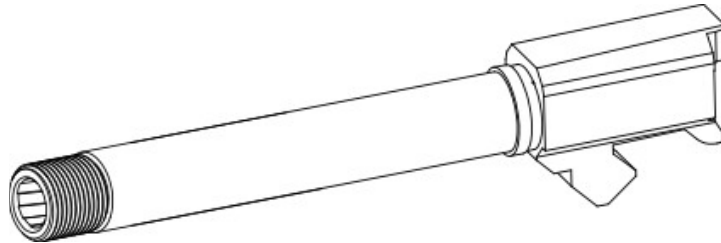
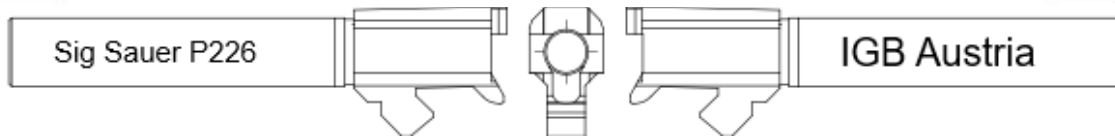

Sig Sauer P226 9x19 Threaded / Gewinde L=127 MM (5")

Caliber Kaliber	Profile Profil	Threading Gewinde	Order No. Artikelnr.	Threading Gewinde	Order No. Artikelnr.	Price Preis
9x19	Hexa	1/2x28	S03-H919-127-G01	13,5x1L	S03-H919-127-G04	G+A01
9x19	Poly	1/2x28	S03-P919-127-G01	13,5x1L	S03-P919-127-G04	G+A01
9x21	Hexa	1/2x28	S03-H919-127-G01	13,5x1L	S03-H919-127-G04	G+A01
9x21	Poly	1/2x28	S03-P921-127-G01	13,5x1L	S03-P921-127-G04	G+A01
7,65 Para	Hexa	1/2x28	S03-H919-127-G01	13,5x1L	S03-H919-127-G04	G+A01

More threadings on request / Mehr Gewinde auf Anfrage

Accessories / Zubehör

	Price / Preis
Model Shark	A09
Model Shark Compact	A09
Steel Thread Protector	A08

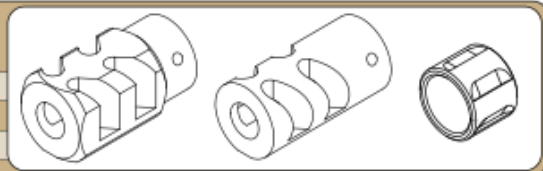

Add Custom Surface Oberflächenoptionen

	Price / Preis
PVD (Gold, Silver, Tan, Bronze, ...)	Base + A05
Sandblast / Sandgestrahlt	Base + A04
Twisted Fluted / Spiralgefütet	Base + A02
Straight Fluted / Geradegefütet	Base + A02

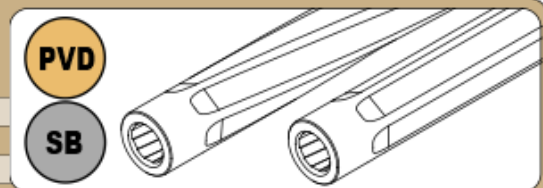

IGB BARRELS FOR SIG SAUER

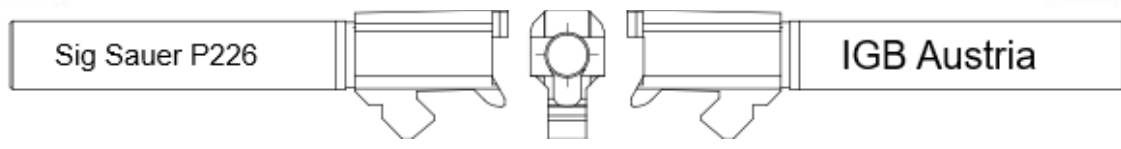

P226 40 S&W

Sig Sauer P226 .40 S&W Standard Length (113 MM)

Order No. Artikelnr.	From Von	Inner Profile Innenprofil	To Zu	Length Länge	Price Preis
S04-H040-S113	40 S&W	Hexagonal	40 S&W	114 MM	G
S04-H357-S113	40 S&W	Hexagonal	357 Sig	114 MM	G
S04-P919-S113	40 S&W	Polygonal	9x19	114 MM	G
S04-H919-S113	40 S&W	Hexagonal	9x19	114 MM	G
S04-P921-S113	40 S&W	Polygonal	9x21	114 MM	G
S04-H919-S113	40 S&W	Hexagonal	9x21	114 MM	G
S04-H765-S113	40 S&W	Hexagonal	7,65 Para*	114 MM	G

*9mm Magazine can be used / 9mm Magazin kann verwendet werden

Sig Sauer P226 .40 S&W L=153 MM (6")

Order No. Artikelnr.	From Von	Inner Profile Innenprofil	To Zu	Length Länge	Price Preis
S04-H040-153	40 S&W	Hexagonal	40 S&W	153 MM	P
S04-H357-153	40 S&W	Hexagonal	357 Sig	153 MM	P
S04-P919-153	40 S&W	Polygonal	9x19	153 MM	P
S04-H919-153	40 S&W	Hexagonal	9x19	153 MM	P
S04-P921-153	40 S&W	Polygonal	9x21	153 MM	P
S04-H919-153	40 S&W	Hexagonal	9x21	153 MM	P

Sig Sauer P226 .40 S&W L=191 MM (7.5")

Order No. Artikelnr.	From Von	Inner Profile Innenprofil	To Zu	Length Länge	Price Preis
S04-H040-191	40 S&W	Hexagonal	40 S&W	191 MM	Q
S04-H357-191	40 S&W	Hexagonal	357 Sig	191 MM	Q
S04-P919-191	40 S&W	Polygonal	9x19	191 MM	Q
S04-H919-191	40 S&W	Hexagonal	9x19	191 MM	Q
S04-P921-191	40 S&W	Polygonal	9x21	191 MM	Q
S04-H919-191	40 S&W	Hexagonal	9x21	191 MM	Q

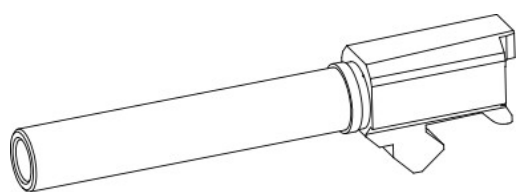

IGB BARRELS FOR SIG SAUER

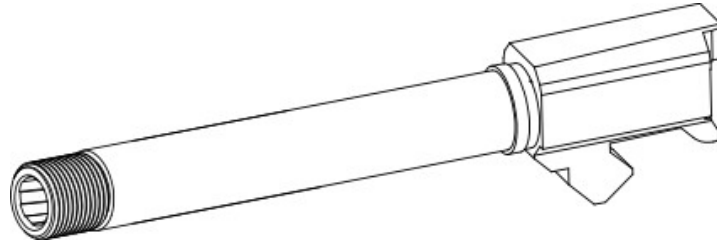
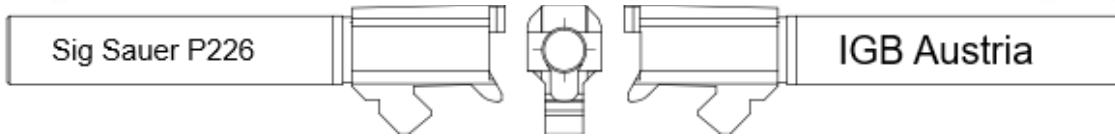

Sig Sauer P226 .40 S&W Threaded / Gewinde L=127 MM (5")

Caliber Kaliber	Profile Profil	Threading Gewinde	Order No. Artikelnr.	Threading Gewinde	Order No. Artikelnr.	Price Preis
40 S&W	Hexa	1/2x28	S04-H040-127-G01	13,5x1L	S04-H040-127-G01	G+A01
357 Sig	Hexa	1/2x28	S04-H357-127-G01	13,5x1L	S04-H357-127-G01	G+A01
9x19	Hexa	1/2x28	S04-H919-127-G01	13,5x1L	S04-H919-127-G04	G+A01
9x19	Poly	1/2x28	S04-P919-127-G01	13,5x1L	S04-P919-127-G04	G+A01
9x21	Hexa	1/2x28	S04-H919-127-G01	13,5x1L	S04-H919-127-G04	G+A01
9x21	Poly	1/2x28	S04-P921-127-G01	13,5x1L	S04-P921-127-G04	G+A01
7,65 Para	Hexa	1/2x28	S04-H919-127-G01	13,5x1L	S04-H919-127-G04	G+A01

More threadings on request / Mehr Gewinde auf Anfrage

Accessories / Zubehör

	Price / Preis
Model Shark	A09
Model Shark Compact	A09
Steel Thread Protector	A08

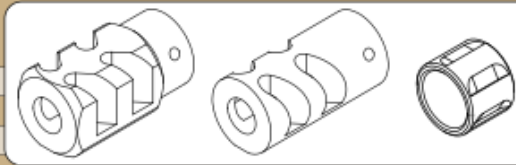

Add Custom Surface Oberflächenoptionen

	Price / Preis
PVD (Gold, Silver, Tan, Bronze, ...)	Base + A05
Sandblast / Sandgestrahlt	Base + A04
Twisted Fluted / Spiralgefütet	Base + A02
Straight Fluted / Geradegefütet	Base + A02

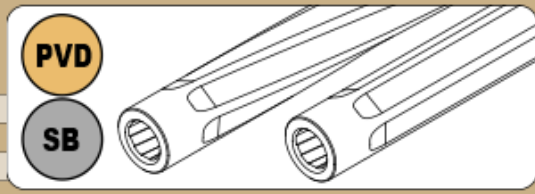

IGB BARRELS FOR SIG SAUER

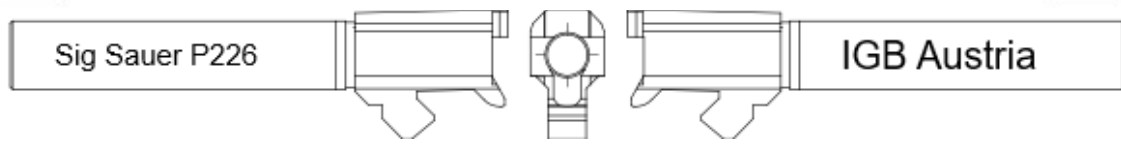

P226 X5 9x19

Sig Sauer P226 X5 9x19 Standard Length (128 MM)

Order No. Artikelnr.	From Von	Inner Profile Innenprofil	To Zu	Length Länge	Price Preis
S05-P919-S128	9x19	Polygonal	9x19	128 MM	G
S05-H919-S128	9x19	Hexagonal	9x19	128 MM	G
S05-P921-S128	9x19	Polygonal	9x21	128 MM	G
S05-H919-S128	9x19	Hexagonal	9x21	128 MM	G
S05-H765-S128	9x19	Hexagonal	7,65 Para*	128 MM	G

*9mm Magazine can be used / 9mm Magazin kann verwendet werden

Sig Sauer X5 P226 9x19 L=153 MM (6")

Order No. Artikelnr.	From Von	Inner Profile Innenprofil	To Zu	Length Länge	Price Preis
S05-P919-153	9x19	Polygonal	9x19	153 MM	P
S05-H919-153	9x19	Hexagonal	9x19	153 MM	P
S05-P921-153	9x19	Polygonal	9x21	153 MM	P
S05-H919-153	9x19	Hexagonal	9x21	153 MM	P

Sig Sauer P226 X5 9x19 L=191 MM (7.5")

Order No. Artikelnr.	From Von	Inner Profile Innenprofil	To Zu	Length Länge	Price Preis
S05-P919-191	9x19	Polygonal	9x19	191 MM	Q
S05-H919-191	9x19	Hexagonal	9x19	191 MM	Q
S05-P921-191	9x19	Polygonal	9x21	191 MM	Q
S05-H919-191	9x19	Hexagonal	9x21	191 MM	Q

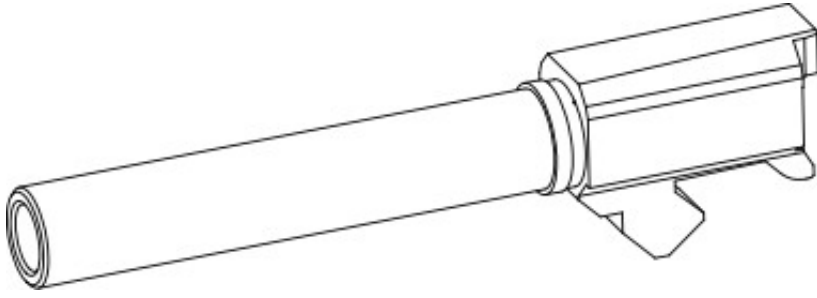

IGB BARRELS FOR SIG SAUER

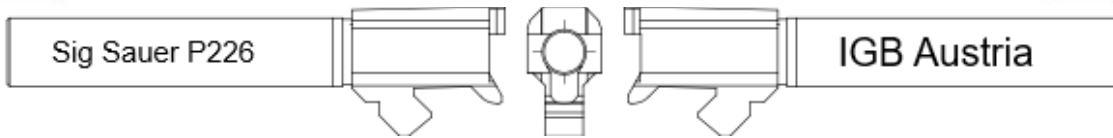

Sig Sauer P226 X5 9x19 Threaded / Gewinde L=142 MM (5.6")

Caliber Kaliber	Profile Profil	Threading Gewinde	Order No. Artikelnr.	Threading Gewinde	Order No. Artikelnr.	Price Preis
9x19	Hexa	1/2x28	S05-H919-142-G01	13,5x1L	S03-H919-142-G04	G+A01
9x19	Poly	1/2x28	S05-P919-142-G01	13,5x1L	S03-P919-142-G04	G+A01
9x21	Hexa	1/2x28	S05-H919-142-G01	13,5x1L	S03-H919-142-G04	G+A01
9x21	Poly	1/2x28	S05-P921-142-G01	13,5x1L	S03-P921-142-G04	G+A01
7,65	Hexa	1/2x28	S05-H919-142-G01	13,5x1L	S03-H919-142-G04	G+A01

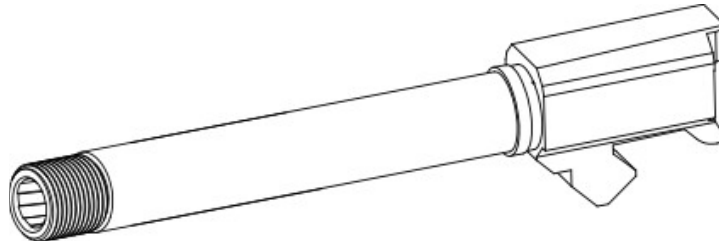

Sig Sauer P226 X5 9x19 Threaded / Gewinde L=142 MM (5.6")

Caliber Kaliber	Profile Profil	Threading Gewinde	Order No. Artikelnr.	Threading Gewinde	Order No. Artikelnr.	Price Preis
9x19	Hexa	M14x1	S05-H919-142-G05	M15x1	S07-H919-142-G07	G+A01
9x19	Poly	M14x1	S05-P919-142-G05	M15x1	S07-P919-142-G07	G+A01
9x21	Hexa	M14x1	S05-H919-142-G05	M15x1	S07-H919-142-G07	G+A01
9x21	Poly	M14x1	S05-P921-142-G05	M15x1	S07-P921-142-G07	G+A01
7,65	Hexa	M14x1	S05-H919-142-G05	M15x1	S07-H919-142-G07	G+A01

More threadings on request / Mehr Gewinde auf Anfrage

Accessories / Zubehör

	Price / Preis
Model Shark	A09
Model Shark Compact	A09
Steel Thread Protector	A08

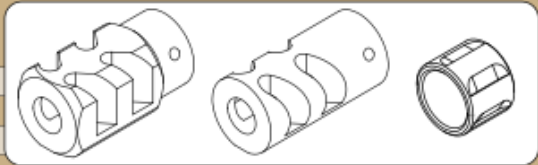

Add Custom Surface Oberflächenoptionen

	Price / Preis
PVD (Gold, Silver, Tan, Bronze, ...)	Base + A05
Sandblast / Sandgestrahlt	Base + A04
Twisted Fluted / Spiralgeflutet	Base + A02
Straight Fluted / Geradegeflutet	Base + A02

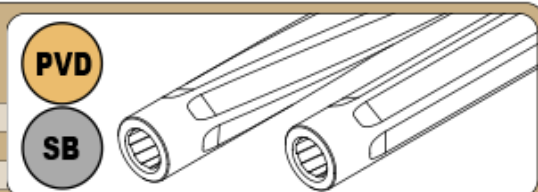

IGB BARRELS FOR SIG SAUER

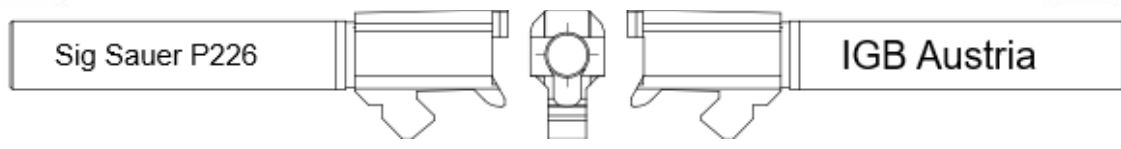

P226 X5 .40 S&W

Sig Sauer P226 X5 .40 S&W Standard Length (128 MM)

Order No. Artikelnr.	From Von	Inner Profile Innenprofil	To Zu	Length Länge	Price Preis
S07-H040-S128	40 S&W	Hexagonal	40 S&W	128 MM	G
S07-H357-S128	40 S&W	Hexagonal	357 Sig	128 MM	G
S07-P919-S128	40 S&W	Polygonal	9x19	128 MM	G
S07-H919-S128	40 S&W	Hexagonal	9x19	128 MM	G
S07-P921-S128	40 S&W	Polygonal	9x21	128 MM	G
S07-H919-S128	40 S&W	Hexagonal	9x21	128 MM	G
S07-H765-S128	40 S&W	Hexagonal	7,65 Para*	128 MM	G

*9mm Magazine can be used / 9mm Magazin kann verwendet werden

Sig Sauer P226 X5 .40 S&W L=153 MM (6")

Order No. Artikelnr.	From Von	Inner Profile Innenprofil	To Zu	Length Länge	Price Preis
S07-H040-153	40 S&W	Hexagonal	40 S&W	153 MM	P
S07-H357-153	40 S&W	Hexagonal	357 Sig	153 MM	P
S07-P919-153	40 S&W	Polygonal	9x19	153 MM	P
S07-H919-153	40 S&W	Hexagonal	9x19	153 MM	P
S07-P921-153	40 S&W	Polygonal	9x21	153 MM	P
S07-H919-153	40 S&W	Hexagonal	9x21	153 MM	P

Sig Sauer P226 X5 .40 S&W L=191 MM (7.5")

Order No. Artikelnr.	From Von	Inner Profile Innenprofil	To Zu	Length Länge	Price Preis
S07-H040-191	40 S&W	Hexagonal	40 S&W	191 MM	Q
S07-H357-191	40 S&W	Hexagonal	357 Sig	191 MM	Q
S07-P919-191	40 S&W	Polygonal	9x19	191 MM	Q
S07-H919-191	40 S&W	Hexagonal	9x19	191 MM	Q
S07-P921-191	40 S&W	Polygonal	9x21	191 MM	Q
S07-H919-191	40 S&W	Hexagonal	9x21	191 MM	Q

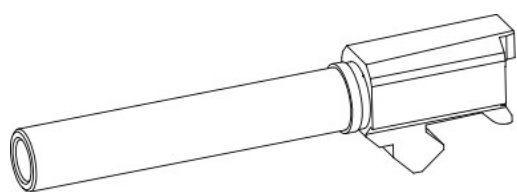

IGB BARRELS FOR SIG SAUER

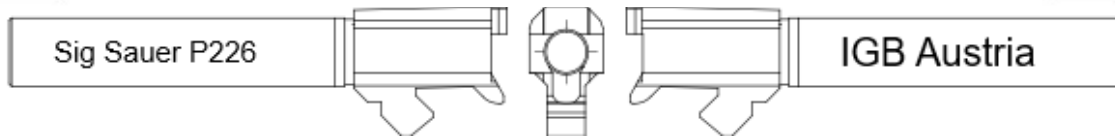

Sig Sauer P226 X5 .40 S&W Threaded / Gewinde L=142 MM (5.6")

Caliber Kaliber	Profile Profil	Threading Gewinde	Order No. Artikelnr.	Threading Gewinde	Order No. Artikelnr.	Price Preis
40 S&W	Hexa	1/2x28	S07-H040-142-G01	13,5x1L	S07-H040-142-G04	G+A01
357 Sig	Hexa	1/2x28	S07-H357-142-G01	13,5x1L	S07-H357-142-G04	G+A01
9x19	Hexa	1/2x28	S07-H919-142-G01	13,5x1L	S07-H919-142-G04	G+A01
9x19	Poly	1/2x28	S07-P919-142-G01	13,5x1L	S07-P919-142-G04	G+A01
9x21	Hexa	1/2x28	S07-H919-142-G01	13,5x1L	S07-H919-142-G04	G+A01
9x21	Poly	1/2x28	S07-P921-142-G01	13,5x1L	S07-P921-142-G04	G+A01
7,65	Hexa	1/2x28	S07-H919-142-G01	13,5x1L	S07-H919-142-G04	G+A01

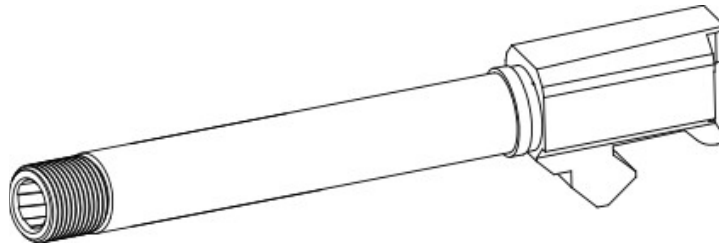

Sig Sauer P226 X5 .40 S&W Threaded / Gewinde L=142 MM (5.6")

Caliber Kaliber	Profile Profil	Threading Gewinde	Order No. Artikelnr.	Threading Gewinde	Order No. Artikelnr.	Price Preis
40 S&W	Hexa	M14x1	S07-H040-142-G05	M15x1	S07-H040-142-G07	G+A01
357 Sig	Hexa	M14x1	S07-H357-142-G05	M15x1	S07-H357-142-G07	G+A01
9x19	Hexa	M14x1	S07-H919-142-G05	M15x1	S07-H919-142-G07	G+A01
9x19	Poly	M14x1	S07-P919-142-G05	M15x1	S07-P919-142-G07	G+A01
9x21	Hexa	M14x1	S07-H919-142-G05	M15x1	S07-H919-142-G07	G+A01
9x21	Poly	M14x1	S07-P921-142-G05	M15x1	S07-P921-142-G07	G+A01
7,65	Hexa	M14x1	S07-H919-142-G05	M15x1	S07-H919-142-G07	G+A01

More threadings on request / Mehr Gewinde auf Anfrage

Add Custom Surface Oberflächenoptionen	Price / Preis
PVD (Gold, Silver, Tan, Bronze, ...)	Base + A05
Sandblast / Sandgestrahlt	Base + A04
Twisted Fluted / Spiralgefütet	Base + A02
Straight Fluted / Geradegefütet	Base + A02

PVD

SB

IGB BARRELS FOR SIG SAUER

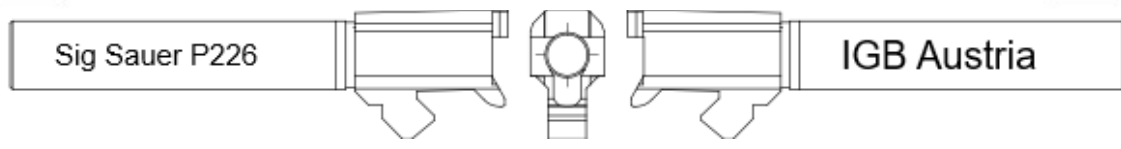

P226 X6 9x19

Sig Sauer P226 X6 9x19 Standard Length (153 MM)

Order No. Artikelnr.	From Von	Inner Profile Innenprofil	To Zu	Length Länge	Price Preis
S08-P919-S153	9x19	Polygonal	9x19	153 MM	P
S08-H919-S153	9x19	Hexagonal	9x19	153 MM	P
S08-P921-S153	9x19	Polygonal	9x21	153 MM	P
S08-H919-S153	9x19	Hexagonal	9x21	153 MM	P
S08-H765-S153	9x19	Hexagonal	7,65 Para*	153 MM	P

*9mm Magazine can be used / 9mm Magazin kann verwendet werden

Sig Sauer P226 X6 9x19 L=191 MM (7.5")

Order No. Artikelnr.	From Von	Inner Profile Innenprofil	To Zu	Length Länge	Price Preis
S08-P919-191	9x19	Polygonal	9x19	191 MM	Q
S08-H919-191	9x19	Hexagonal	9x19	191 MM	Q
S08-P921-191	9x19	Polygonal	9x21	191 MM	Q
S08-H919-191	9x19	Hexagonal	9x21	191 MM	Q

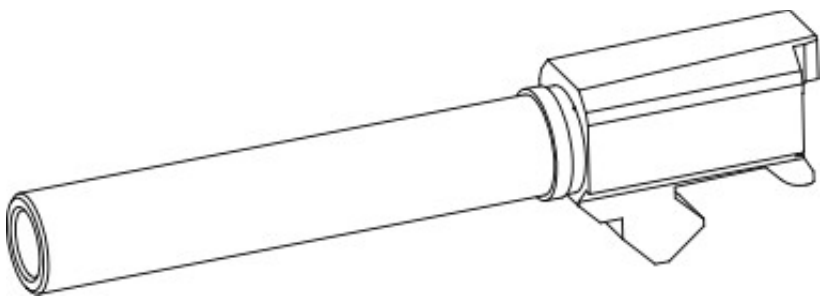

Polygonal vs Hexagonal

Polygonal is very smooth inside and therefore very gastight for high velocity.
 Polygonal ist formbedingt sehr Gasdicht für hohe Geschwindigkeiten.

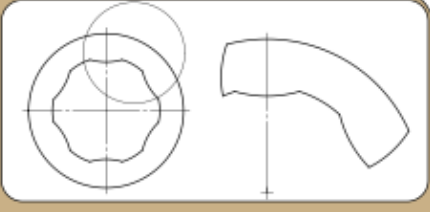
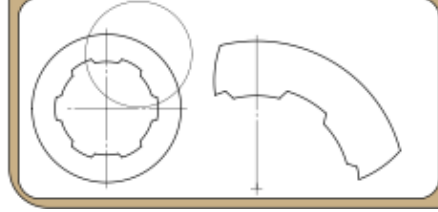

Hexagonal is the more classic approach and also well suited for pure lead.
 Hexagonal ist der klassischere Ansatz und gut geeignet für reine Bleigeschoße.

IGB BARRELS FOR SIG SAUER

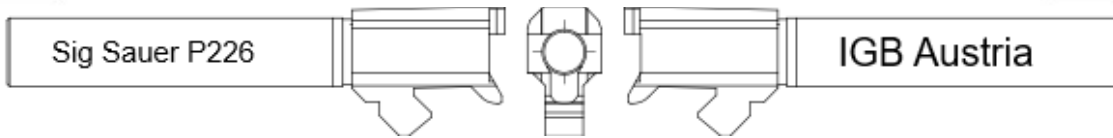

Sig Sauer P226 X6 9x19 Threaded / Gewinde L=167 MM (6.6")

Caliber Kaliber	Profile Profil	Threading Gewinde	Order No. Artikelnr.	Threading Gewinde	Order No. Artikelnr.	Price Preis
9x19	Hexa	1/2x28	S08-H919-167-G01	13,5x1L	S08-H919-167-G04	P+A01
9x19	Poly	1/2x28	S08-P919-167-G01	13,5x1L	S08-P919-167-G04	P+A01
9x21	Hexa	1/2x28	S08-H919-167-G01	13,5x1L	S08-H919-167-G04	P+A01
9x21	Poly	1/2x28	S08-P921-167-G01	13,5x1L	S08-P921-167-G04	P+A01
7,65	Hexa	1/2x28	S08-H919-167-G01	13,5x1L	S08-H919-167-G04	P+A01

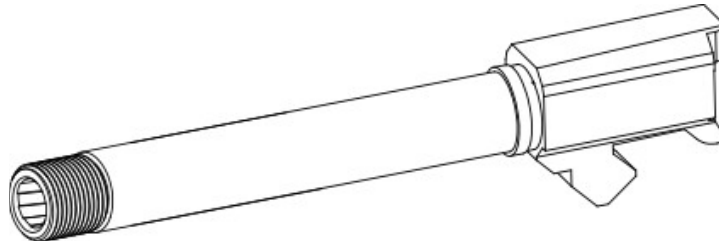

Sig Sauer P226 X6 9x19 Threaded / Gewinde L=142 MM (6.6")

Caliber Kaliber	Profile Profil	Threading Gewinde	Order No. Artikelnr.	Threading Gewinde	Order No. Artikelnr.	Price Preis
9x19	Hexa	M14x1	S08-H919-167-G05	M15x1	S08-H919-167-G07	P+A01
9x19	Poly	M14x1	S08-P919-167-G05	M15x1	S08-P919-167-G07	P+A01
9x21	Hexa	M14x1	S08-H919-167-G05	M15x1	S08-H919-167-G07	P+A01
9x21	Poly	M14x1	S08-P921-167-G05	M15x1	S08-P921-167-G07	P+A01
7,65	Hexa	M14x1	S08-H919-167-G05	M15x1	S08-H919-167-G07	P+A01

More threadings on request / Mehr Gewinde auf Anfrage

Accessories / Zubehör

	Price / Preis
Model Shark	A09
Model Shark Compact	A09
Steel Thread Protector	A08

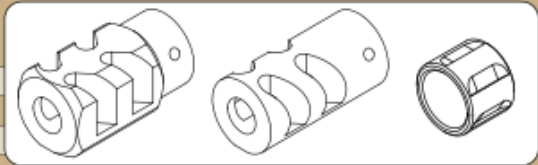

Add Custom Surface Oberflächenoptionen

	Price / Preis
PVD (Gold, Silver, Tan, Bronze, ...)	Base + A05
Sandblast / Sandgestrahlt	Base + A04
Twisted Fluted / Spiralgefütet	Base + A02
Straight Fluted / Geradegefütet	Base + A02

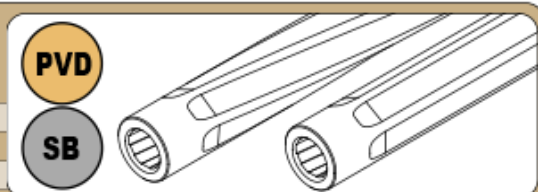

IGB BARRELS IDEAS

Make it YOUR Gun with the IGB Variety
 Machen Sie es zu IHRER Pistole mit den IGB Variationen.

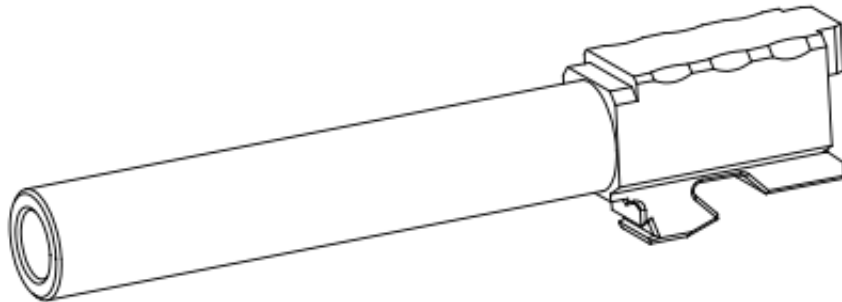

**Caliberchange
 Kaliberwechsel**

Order your Magazine directly from us!
 Magazin gleich bei uns mitbestellen!

Changing from a bigger cartridge bottom to a smaller one will require you to get a smaller Magazine!
 Example; .357 to 9x19 = Magazine needed / .40 to .357 = No Magazine needed

Wechsel von bestimmten Patronenbodendurchmessern benötigt ein Magazin!
 Beispiel; .357 zu 9x19 = Magazin benötigt / .40 zu .357 = Kein Magazin benötigt

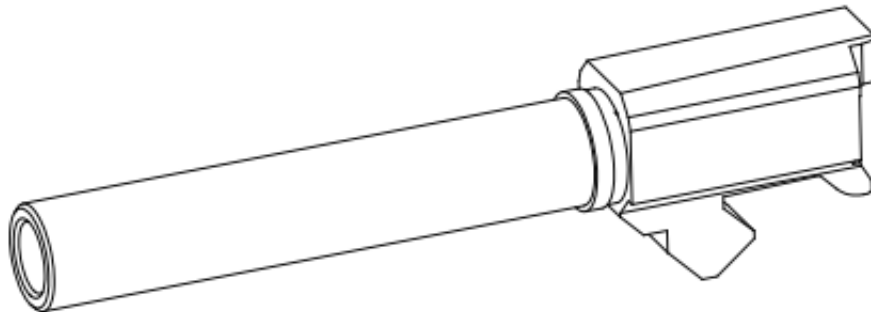

Polygonal vs Hexagonal

Polygonal is very smooth inside and therefore very gastight for high velocity.
 Polygonal ist formbedingt sehr Gasdicht für hohe Geschwindigkeiten.

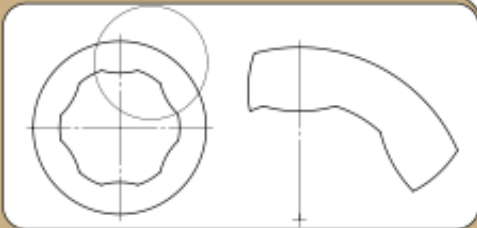
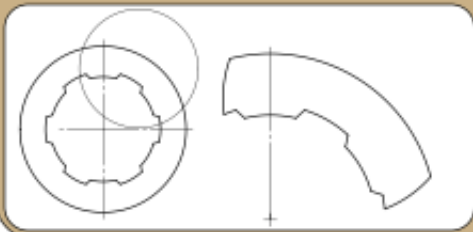

Hexagonal is the more classic approach and also well suited for pure lead.
 Hexagonal ist der klassischere Ansatz und gut geeignet für reine Bleigeschöße.

IGB BARRELS FOR SIG SAUER

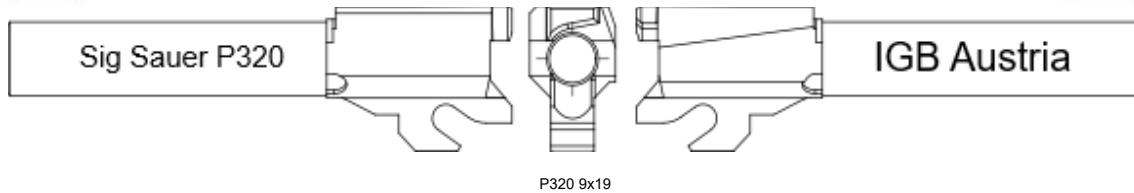

Sig Sauer P320 9x19 Standard Length (121 MM)

Order No. Artikelnr.	From Von	Inner Profile Innenprofil	To Zu	Length Länge	Price Preis
S15-P919-S121	9x19	Polygonal	9x19	121 MM	G
S15-H919-S121	9x19	Hexagonal	9x19	121 MM	G
S15-P921-S121	9x19	Polygonal	9x21	121 MM	G
S15-H919-S121	9x19	Hexagonal	9x21	121 MM	G
S15-H765-S121	9x19	Hexagonal	7,65 Para*	121 MM	G

*9mm Magazine can be used / 9mm Magazin kann verwendet werden

Sig Sauer P320 9x19 L=153 MM (6")

Order No. Artikelnr.	From Von	Inner Profile Innenprofil	To Zu	Length Länge	Price Preis
S15-P919-153	9x19	Polygonal	9x19	153 MM	P
S15-H919-153	9x19	Hexagonal	9x19	153 MM	P
S15-P921-153	9x19	Polygonal	9x21	153 MM	P
S15-H919-153	9x19	Hexagonal	9x21	153 MM	P

Sig Sauer P320 9x19 L=191 MM (7.5")

Order No. Artikelnr.	From Von	Inner Profile Innenprofil	To Zu	Length Länge	Price Preis
S15-P919-191	9x19	Polygonal	9x19	191 MM	Q
S15-H919-191	9x19	Hexagonal	9x19	191 MM	Q
S15-P921-191	9x19	Polygonal	9x21	191 MM	Q
S15-H919-191	9x19	Hexagonal	9x21	191 MM	Q

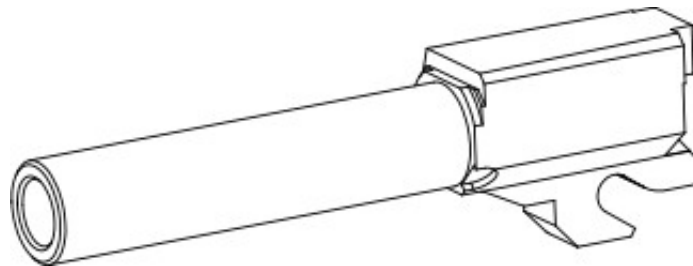

IGB BARRELS FOR SIG SAUER

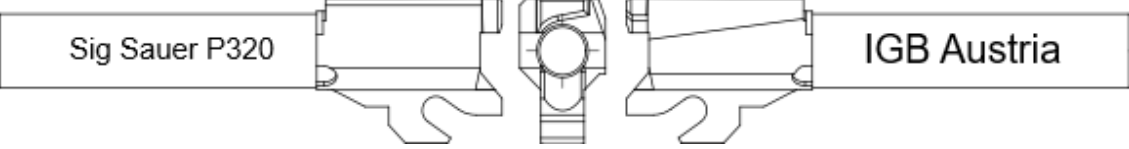

Sig Sauer P320 9x19 Threaded / Gewinde L=135 MM (5.3")

Caliber Kaliber	Profile Profil	Threading Gewinde	Order No. Artikelnr.	Threading Gewinde	Order No. Artikelnr.	Price Preis
9x19	Hexa	1/2x28	S15-H919-135-G01	13,5x1L	S15-H919-135-G04	G+A01
9x19	Poly	1/2x28	S15-P919-135-G01	13,5x1L	S15-P919-135-G04	G+A01
9x21	Hexa	1/2x28	S15-H919-135-G01	13,5x1L	S15-H919-135-G04	G+A01
9x21	Poly	1/2x28	S15-P921-135-G01	13,5x1L	S15-P921-135-G04	G+A01
7,65	Hexa	1/2x28	S15-H919-135-G01	13,5x1L	S15-H919-135-G04	G+A01

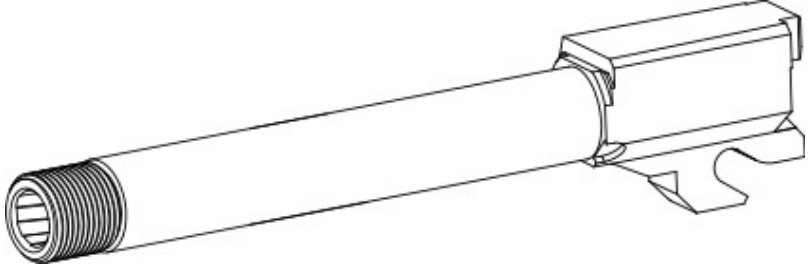

Sig Sauer P320 9x19 Threaded / Gewinde L=135 MM (5.3")

Caliber Kaliber	Profile Profil	Threading Gewinde	Order No. Artikelnr.	Price Preis
9x19	Hexa	M14x1	S15-H919-135-G05	G+A01
9x19	Poly	M14x1	S15-P919-135-G05	G+A01
9x21	Hexa	M14x1	S15-H919-135-G05	G+A01
9x21	Poly	M14x1	S15-P921-135-G05	G+A01
7,65	Hexa	M14x1	S15-H919-135-G05	G+A01

More threadings on request / Mehr Gewinde auf Anfrage

Accessories / Zubehör		Price / Preis		
Model Shark		A09		
Model Shark Compact		A09		
Steel Thread Protector		A08		

Add Custom Surface Oberflächenoptionen		Price / Preis		
PVD (Gold, Silver, Tan, Bronze, ...)		Base + A05	PVD	
Sandblast / Sandgestrahlt		Base + A04		
Twisted Fluted / Spiralgefütet		Base + A02		
Straight Fluted / Geradegefütet		Base + A02	SB	

IGB BARRELS FOR SIG SAUER

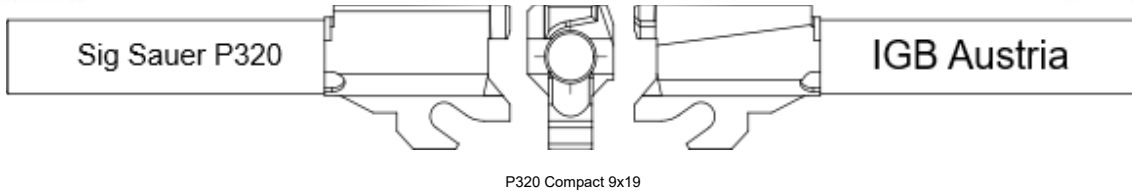

Sig Sauer P320 Compact 9x19 Standard Length (100 MM)

Order No. Artikelnr.	From Von	Inner Profile Innenprofil	To Zu	Length Länge	Price Preis
S16-P919-S100	9x19	Polygonal	9x19	100 MM	G
S16-H919-S100	9x19	Hexagonal	9x19	100 MM	G
S16-P921-S100	9x19	Polygonal	9x21	100 MM	G
S16-H919-S100	9x19	Hexagonal	9x21	100 MM	G
S16-H765-S100	9x19	Hexagonal	7,65 Para*	100 MM	G

*9mm Magazine can be used / 9mm Magazin kann verwendet werden

Sig Sauer P320 Compact 9x19 L=153 MM (6")

Order No. Artikelnr.	From Von	Inner Profile Innenprofil	To Zu	Length Länge	Price Preis
S16-P919-153	9x19	Polygonal	9x19	153 MM	P
S16-H919-153	9x19	Hexagonal	9x19	153 MM	P
S16-P921-153	9x19	Polygonal	9x21	153 MM	P
S16-H919-153	9x19	Hexagonal	9x21	153 MM	P

Sig Sauer P320 Compact 9x19 L=191 MM (7.5")

Order No. Artikelnr.	From Von	Inner Profile Innenprofil	To Zu	Length Länge	Price Preis
S16-P919-191	9x19	Polygonal	9x19	191 MM	Q
S16-H919-191	9x19	Hexagonal	9x19	191 MM	Q
S16-P921-191	9x19	Polygonal	9x21	191 MM	Q
S16-H919-191	9x19	Hexagonal	9x21	191 MM	Q

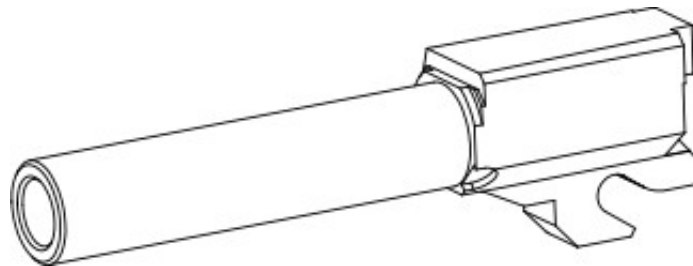

IGB BARRELS FOR SIG SAUER

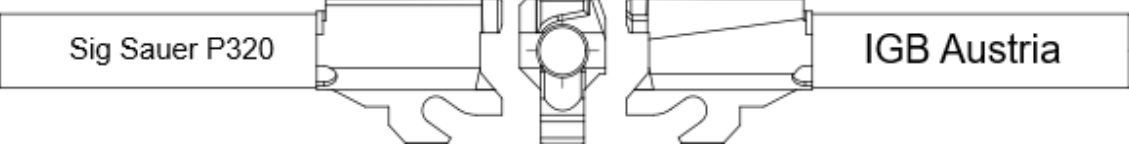

Sig Sauer P320 Compact 9x19 Threaded / Gewinde L=114 MM (4.5")

Caliber Kaliber	Profile Profil	Threading Gewinde	Order No. Artikelnr.	Threading Gewinde	Order No. Artikelnr.	Price Preis
9x19	Hexa	1/2x28	S16-H919-114-G01	13,5x1L	S16-H919-114-G04	G+A01
9x19	Poly	1/2x28	S16-P919-114-G01	13,5x1L	S16-P919-114-G04	G+A01
9x21	Hexa	1/2x28	S16-H919-114-G01	13,5x1L	S16-H919-114-G04	G+A01
9x21	Poly	1/2x28	S16-P921-114-G01	13,5x1L	S16-P921-114-G04	G+A01
7,65	Hexa	1/2x28	S16-H919-114-G01	13,5x1L	S16-H919-114-G04	G+A01

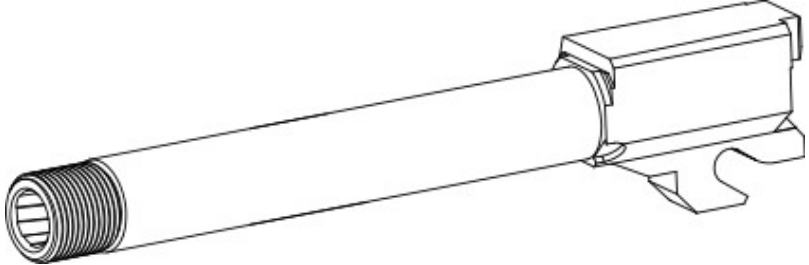

Sig Sauer P320 Compact 9x19 Threaded / Gewinde L=114 MM (4.5")

Caliber Kaliber	Profile Profil	Threading Gewinde	Order No. Artikelnr.	Price Preis
9x19	Hexa	M14x1	S16-H919-114-G05	G+A01
9x19	Poly	M14x1	S16-P919-114-G05	G+A01
9x21	Hexa	M14x1	S16-H919-114-G05	G+A01
9x21	Poly	M14x1	S16-P921-114-G05	G+A01
7,65	Hexa	M14x1	S16-H919-114-G05	G+A01

More threadings on request / Mehr Gewinde auf Anfrage

Accessories / Zubehör		Price / Preis		
Model Shark		A09		
Model Shark Compact		A09		
Steel Thread Protector		A08		

Add Custom Surface Oberflächenoptionen		Price / Preis		
PVD (Gold, Silver, Tan, Bronze, ...)		Base + A05	PVD	
Sandblast / Sandgestrahlt		Base +A04		
Twisted Fluted / Spiralgefütet		Base +A02		
Straight Fluted / Geradegefütet		Base +A02	SB	

IGB BARRELS IDEAS

Make it YOUR Gun with the IGB Variety
 Machen Sie es zu IHRER Pistole mit den IGB Variationen.

Add Custom Surface Oberflächenoptionen

	Price / Preis
PVD (Gold, Silver, Tan, Bronze, ...)	Base + A05
Sandblast / Sandgestrahlt	Base +A04
Twisted Fluted / Spiralgeflutet	Base +A02
Straight Fluted / Geradegeflutet	Base +A02

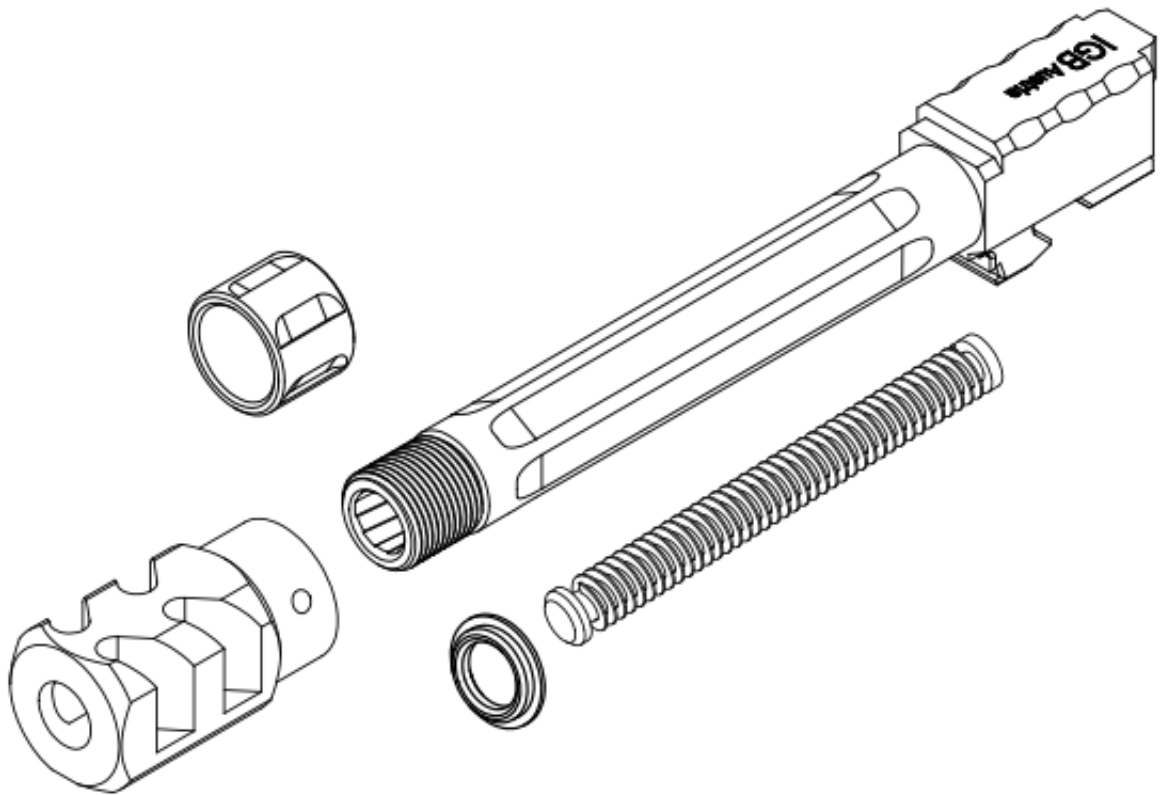
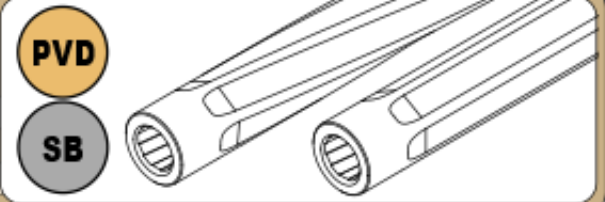

Polygonal vs Hexagonal

Polygonal is very smooth inside and therefore very gastight for high velocity.
 Polygonal ist formbedingt sehr Gasdicht für hohe Geschwindigkeiten.

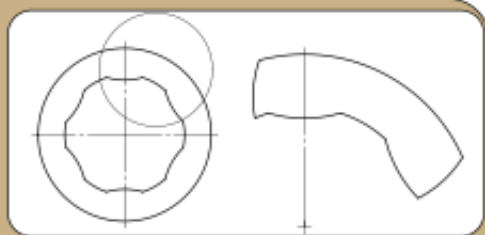
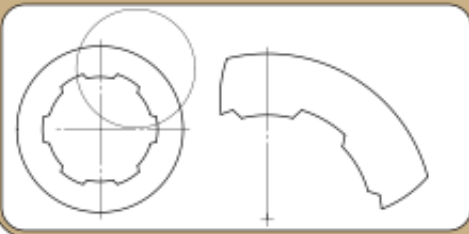

Hexagonal is the more classic approach and also well suited for pure led.
 Hexagonal ist der klassischere Ansatz und gut geeignet für reine Bleigeschöße.

IGB BARRELS FOR SIG SAUER

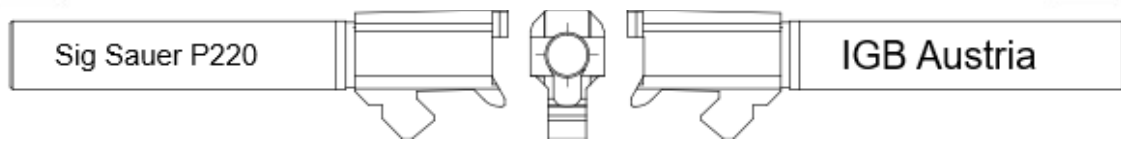

P220 .45 acp

Sig Sauer P220 .45 acp Standard Length (113 MM)

Order No. Artikelnr.	From Von	Inner Profile Innenprofil	To Zu	Length Länge	Price Preis
S01-H045-S113	45 acp	Hexagonal	45 acp	114 MM	G
S01-H400-S113	45 acp	Hexagonal	400 CorBon	114 MM	G

Sig Sauer P220 .45 acp L=153 MM (6")

Order No. Artikelnr.	From Von	Inner Profile Innenprofil	To Zu	Length Länge	Price Preis
S01-H045-153	45 acp	Hexagonal	45 acp	153 MM	P
S01-H400-153	45 acp	Hexagonal	400 CorBon	153 MM	P

Sig Sauer P220 .45 acp L=191 MM (7.5")

Order No. Artikelnr.	From Von	Inner Profile Innenprofil	To Zu	Length Länge	Price Preis
S01-H045-191	45 acp	Hexagonal	45 acp	191 MM	Q
S01-H400-191	45 acp	Hexagonal	400 CorBon	191 MM	Q

Add Custom Surface Oberflächenoptionen

	Price / Preis
PVD (Gold, Silver, Tan, Bronze, ...)	Base + A05
Sandblast / Sandgestrahlt	Base +A04
Twisted Fluted / Spiralgeflutet	Base +A02
Straight Fluted / Geradegeflutet	Base +A02

PVD

SB

Sig Sauer P220 .45 acp Threaded / Gewinde L=127 MM (5")

Caliber Kaliber	Profile Profil	Threading Gewinde	Order No. Artikelnr.	Price Preis
45 acp	Hexa	M15x1	S01-H045-127-G07	G+A01
400 Crbn	Hexa	M15x1	S01-H400-127-G07	G+A01
45 acp	Hexa	M15x1L	S01-H045-127-G08	G+A01
400 Crbn	Hexa	M15x1L	S01-H400-127-G08	G+A01
400 Crbn	Hexa	M14x1	S01-H400-127-G05	G+A01

More threadings on request / Mehr Gewinde auf Anfrage

On request we also produce for / Auf Anfrage auch für

P226 LCD	P228	P229
P365	P220 X6	P220 Hunter
P226 Legion	P229 SL	

For **Sig Sauer 1911** please refer to our 1911 section
Für **Sig Sauer 1911** bitte in unserer 1911 Sektion nachsehen.

For **Sig Sauer P210** please refer to our P210 section
Für **Sig Sauer P210** bitte in unserer P210 Sektion nachsehen.

Polygonal vs Hexagonal

Polygonal is very smooth inside and therefore very gastight for high velocity.

Polygonal ist formbedingt sehr Gasdicht für hohe Geschwindigkeiten.

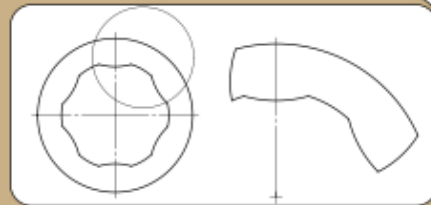
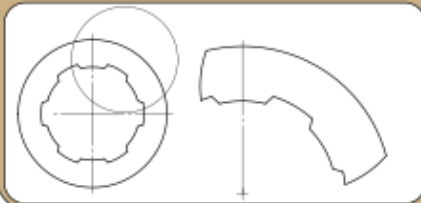

Hexagonal is the more classic approach and also well suited for pure lead.

Hexagonal ist der klassischere Ansatz und gut geeignet für reine Bleigeschoße.

IGB BARRELS IDEAS

Make it YOUR Gun with the IGB Variety
 Machen Sie es zu IHRER Pistole mit den IGB Variationen.

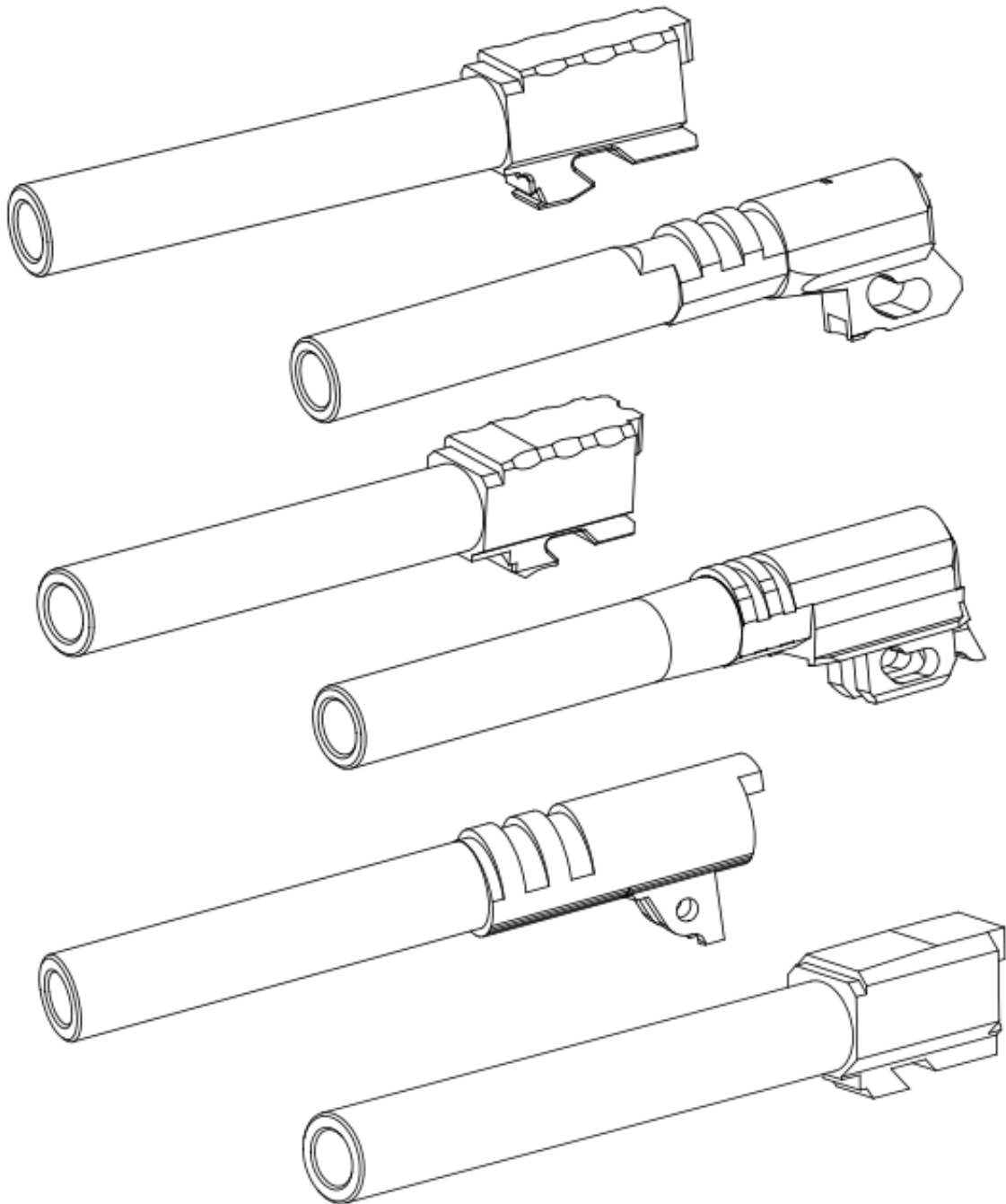

Add Custom Surface Oberflächenoptionen

PVD (Gold, Silver, Tan, Bronze, ...)	Price / Preis Base + A05
Sandblast / Sandgestrahlt	Base +A04
Twisted Fluted / Spiralgeflutet	Base +A02
Straight Fluted / Geradegeflutet	Base +A02

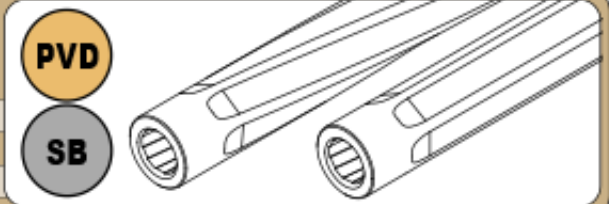

GLOCK CZ S&W SIG SAUER P210 1911 STEYR H&K FN ACCESSORY

ACCESSORY FN H&K STEYR 1911 P210 SIG SAUER S&W CZ GLOCK

IGB BARRELS FOR P210

Sig P210



IGB Austria

Barreltechnology

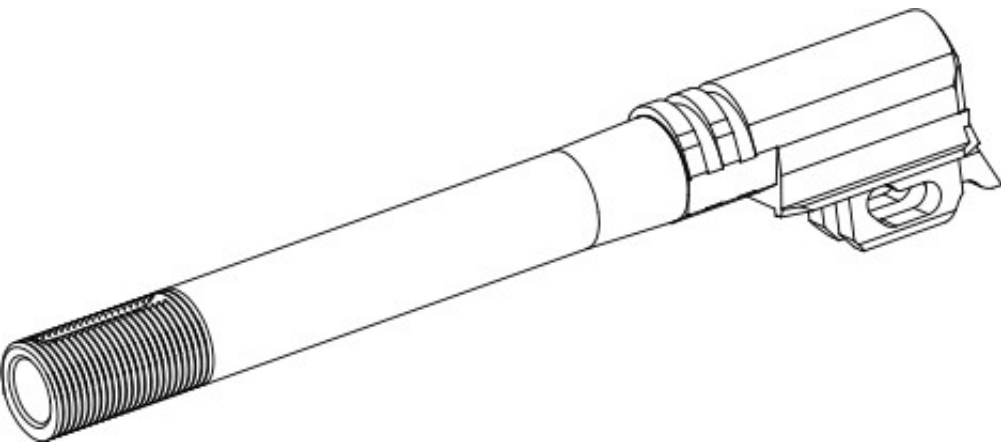
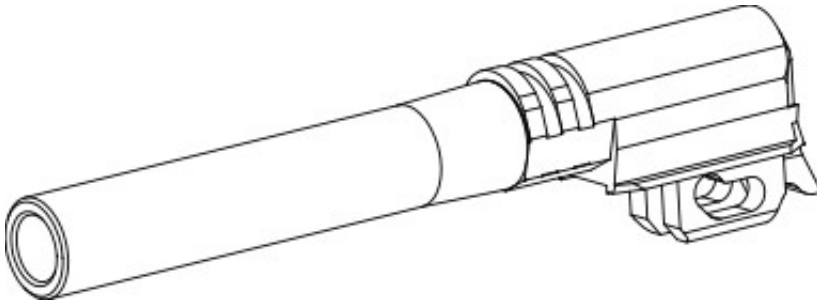

IGB BARRELS FOR P210



Sig P210 - 9x19

Sig P210 - 9x19 Standard Length (126 MM)

Order No. Artikelnr.	From Von	Inner Profile Innenprofil	To Zu	Length Länge	Price Preis
D01-P919-S126	9x19	Polygonal	9x19	126 MM	D
D01-H919-S126	9x19	Hexagonal	9x19	126 MM	D
D01-P921-S126	9x19	Polygonal	9x21	126 MM	D
D01-H765-S126	9x19	Hexagonal	7,65 Para	126 MM	D

Sig P210 - 9x19 L=156 MM (6")

Order No. Artikelnr.	From Von	Inner Profile Innenprofil	To Zu	Length Länge	Price Preis
D01-P919-156	9x19	Polygonal	9x19	156 MM	E
D01-H919-156	9x19	Hexagonal	9x19	156 MM	E
D01-P921-156	9x19	Polygonal	9x21	156 MM	E
D01-H765-156	9x19	Hexagonal	7,65 Para	156 MM	E

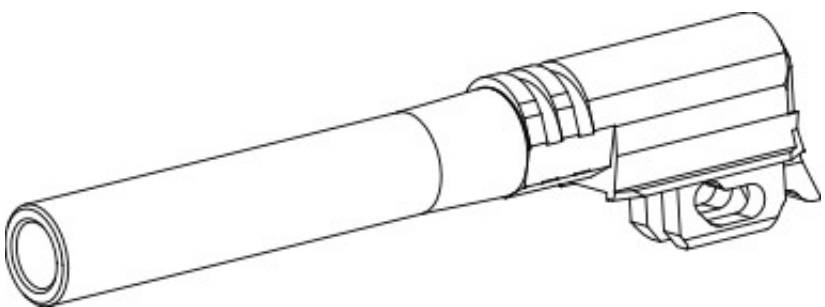

Polygonal vs Hexagonal

Polygonal is very smooth inside and therefore very gastight for high velocity.
 Polygonal ist formbedingt sehr Gasdicht für hohe Geschwindigkeiten.

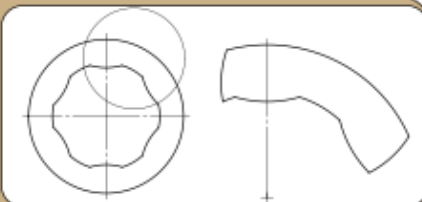
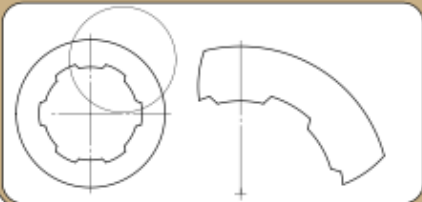

Hexagonal is the more classic approach and also well suited for pure lead.
 Hexagonal ist der klassischere Ansatz und gut geeignet für reine Bleigeschoße.

IGB BARRELS FOR P210

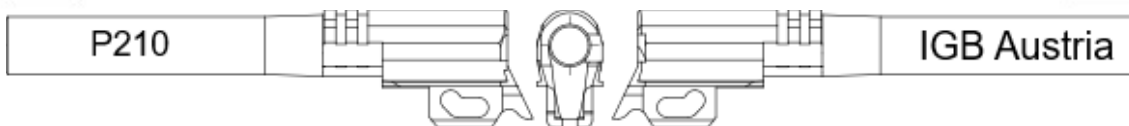

Sig P210 - 9x19 Threaded / Gewinde L=156 MM (6")

Caliber Kaliber	Profile Profil	Threading Gewinde	Order No. Artikelnr.	Price Preis
9x19	Poly	Thread & Slot / Gewinde & Nut	D03-P919-S156	F
9x19	Hexa	Thread & Slot / Gewinde & Nut	D03-H919-S156	F
9x21	Poly	Thread & Slot / Gewinde & Nut	D03-P921-S156	F
7,65 Para	Hexa	Thread & Slot / Gewinde & Nut	D03-H765-S156	F

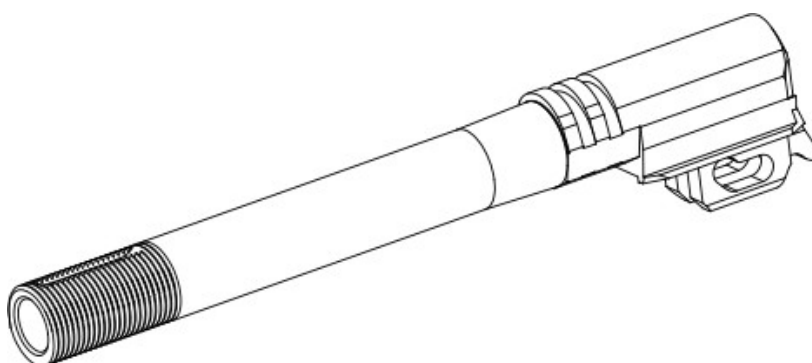

Sig P210 - 9x19 Threaded / Gewinde L=140 MM (5.5")

Caliber Kaliber	Profile Profil	Threading Gewinde	Order No. Artikelnr.	Threading Gewinde	Order No. Artikelnr.	Price Preis
9x19	Poly	1/2x28	D01-P919-140-G01	M13,5x1L	D01-P919-140-G04	D+A01
9x19	Hexa	1/2x28	D01-H919-140-G01	M13,5x1L	D01-H919-140-G04	D+A01
9x21	Poly	1/2x28	D01-P921-140-G01	M13,5x1L	D01-P921-140-G04	D+A01
7,65 Para	Hexa	1/2x28	D01-H765-140-G01	M13,5x1L	D01-H765-140-G04	D+A01

More threadings on request / Mehr Gewinde auf Anfrage

Accessories / Zubehör

	Price / Preis
Model Shark	A09
Model Shark Compact	A09
Steel Thread Protector	A08

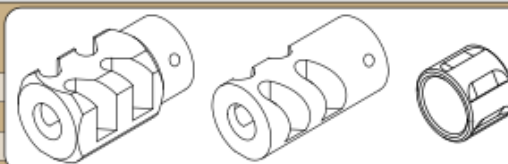

Add Custom Surface Oberflächenoptionen

	Price / Preis
PVD (Gold, Silver, Tan, Bronze, ...)	Base + A05
Sandblast / Sandgestrahlt	Base + A04
Twisted Fluted / Spiralgefütet	Base + A02
Straight Fluted / Geradegefütet	Base + A02

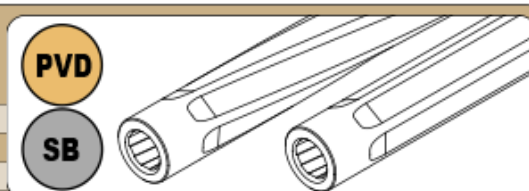

IGB BARRELS FOR P210

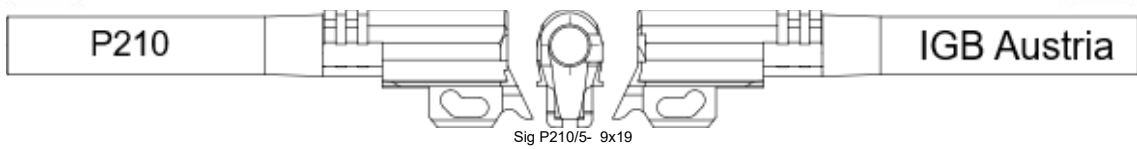

Sig P210/5 - 9x19 Threaded / Gewinde L=156 MM (6")

Caliber Kaliber	Profile Profil	Threading Gewinde	Order No. Artikelnr.	Price Preis
9x19	Poly	Thread & Slot / Gewinde & Nut	D03-P919-S156	F
9x19	Hexa	Thread & Slot / Gewinde & Nut	D03-H919-S156	F
9x21	Poly	Thread & Slot / Gewinde & Nut	D03-P921-S156	F
7,65 Para	Hexa	Thread & Slot / Gewinde & Nut	D03-H765-S156	F

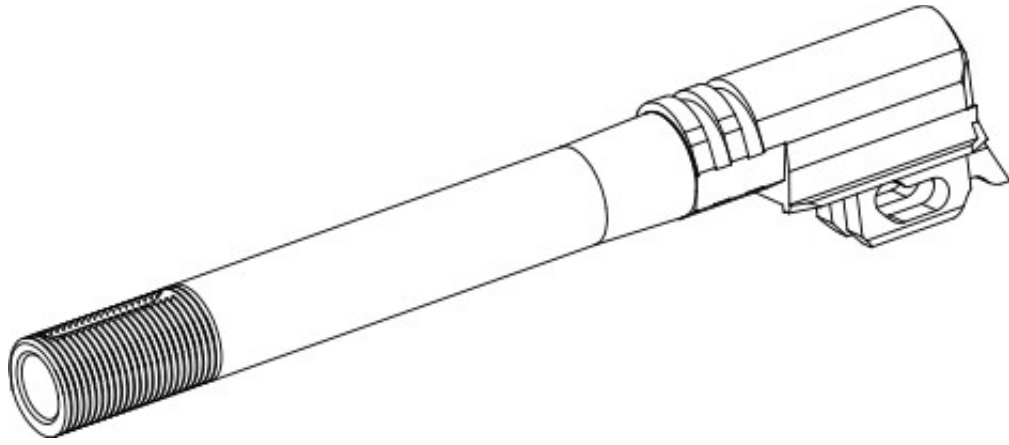

More threadings on request / Mehr Gewinde auf Anfrage

Add Custom Surface Oberflächenoptionen		Price / Preis
PVD (Gold, Silver, Tan, Bronze, ...)	Base +A05	
Sandblast / Sandgestrahlt	Base +A04	
Twisted Fluted / Spiralgefütet	Base +A02	
Straight Fluted / Geradegefütet	Base +A02	

Accessories / Zubehör		Price / Preis
Model Shark	A09	
Model Shark Compact	A09	
Steel Thread Protector	A08	

IGB BARRELS IDEAS

Make it YOUR Gun with the IGB Variety
 Machen Sie es zu IHRER Pistole mit den IGB Variationen.

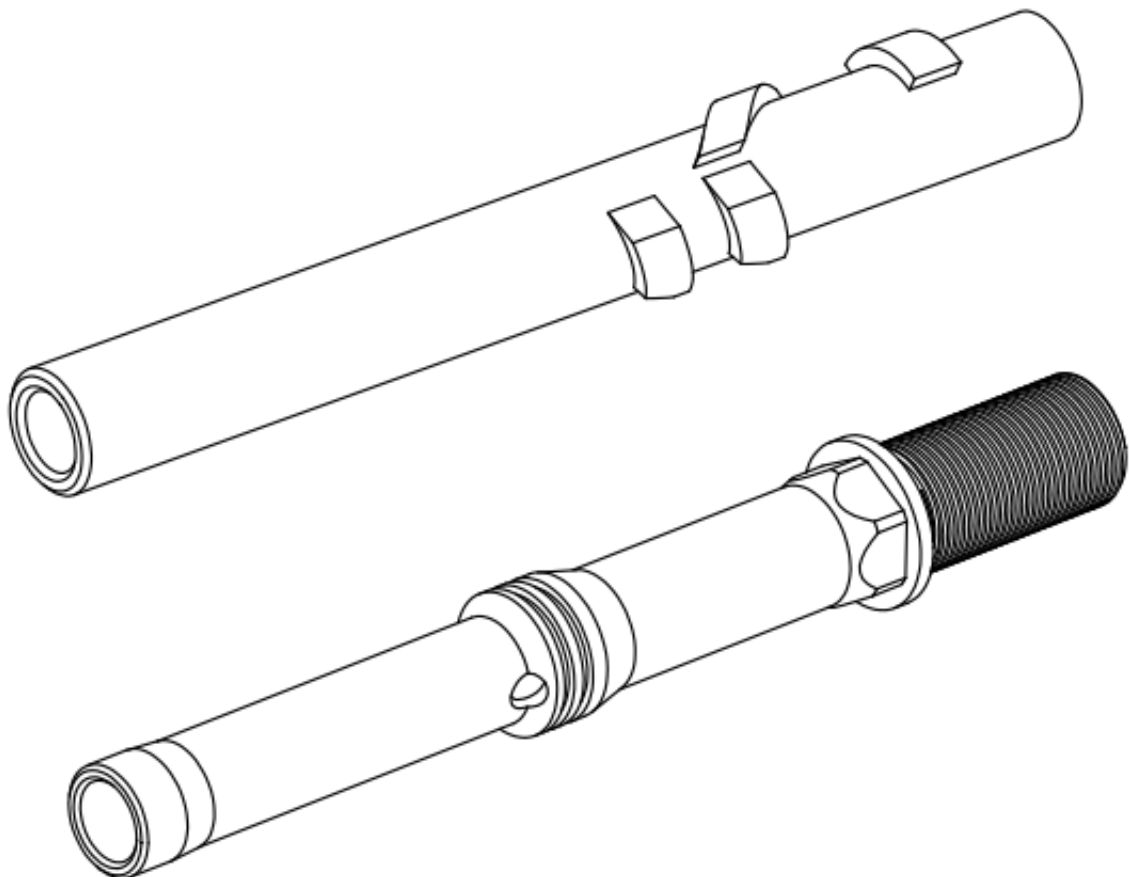

Polygonal vs Hexagonal

Polygonal is very smooth inside and therefore very gastight for high velocity.
 Polygonal ist formbedingt sehr Gasdicht für hohe Geschwindigkeiten.

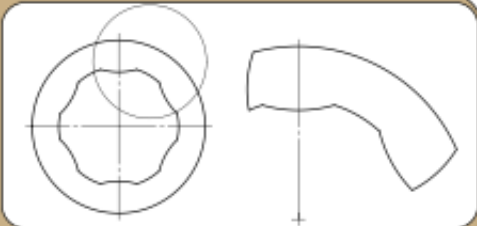
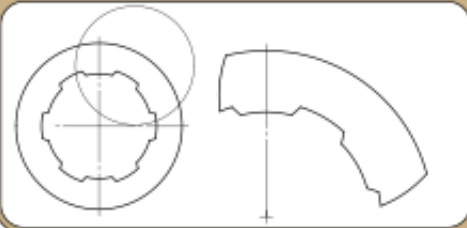

Hexagonal is the more classic approach and also well suited for pure lead.
 Hexagonal ist der klassischere Ansatz und gut geeignet für reine Bleigeschoße.

IGB BARRELS FOR P210



Sig Sauer P210 - 9x19

Sig Sauer P210 - 9x19 Standard Length (126 MM)

Order No. Artikelnr.	From Von	Inner Profile Innenprofil	To Zu	Length Länge	Price Preis
D01-P919-S126	9x19	Polygonal	9x19	126 MM	D
D01-H919-S126	9x19	Hexagonal	9x19	126 MM	D
D01-P921-S126	9x19	Polygonal	9x21	126 MM	D
D01-H765-S126	9x19	Hexagonal	7,65 Para	126 MM	D

Sig Sauer P210 - 9x19 L=156 MM (6")

Order No. Artikelnr.	From Von	Inner Profile Innenprofil	To Zu	Length Länge	Price Preis
D01-P919-156	9x19	Polygonal	9x19	156 MM	E
D01-H919-156	9x19	Hexagonal	9x19	156 MM	E
D01-P921-156	9x19	Polygonal	9x21	156 MM	E
D01-H765-156	9x19	Hexagonal	7,65 Para	156 MM	E

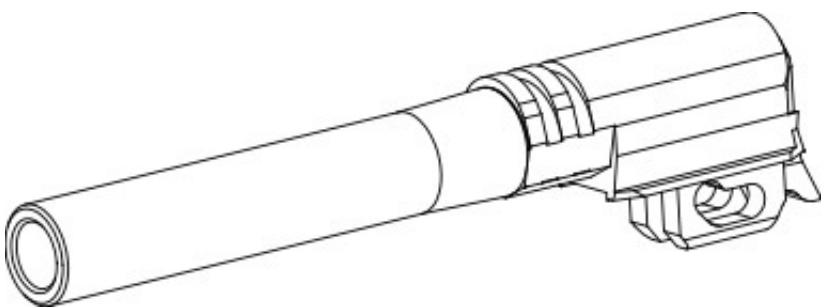

Polygonal vs Hexagonal

Polygonal is very smooth inside and therefore very gastight for high velocity.
 Polygonal ist formbedingt sehr Gasdicht für hohe Geschwindigkeiten.

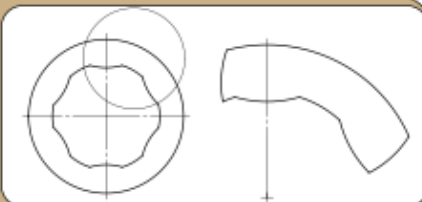
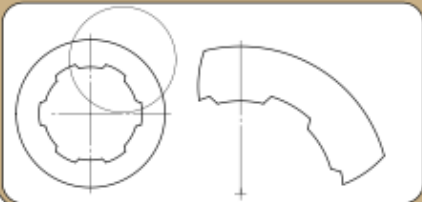

Hexagonal is the more classic approach and also well suited for pure lead.
 Hexagonal ist der klassischere Ansatz und gut geeignet für reine Bleigeschoße.

IGB BARRELS FOR P210

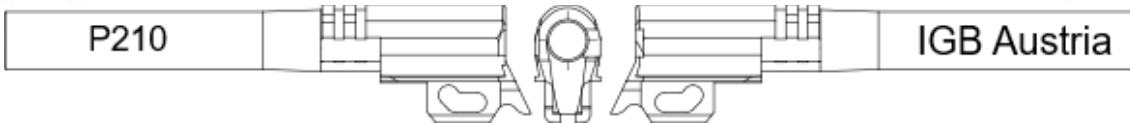

Sig Sauer P210 - 9x19 Threaded / Gewinde L=156 MM (6")

Caliber Kaliber	Profile Profil	Threading Gewinde	Order No. Artikelnr.	Price Preis
9x19	Poly	Thread & Slot / Gewinde & Nut	D03-P919-S156	F
9x19	Hexa	Thread & Slot / Gewinde & Nut	D03-H919-S156	F
9x21	Poly	Thread & Slot / Gewinde & Nut	D03-P921-S156	F
7,65 Para	Hexa	Thread & Slot / Gewinde & Nut	D03-H765-S156	F

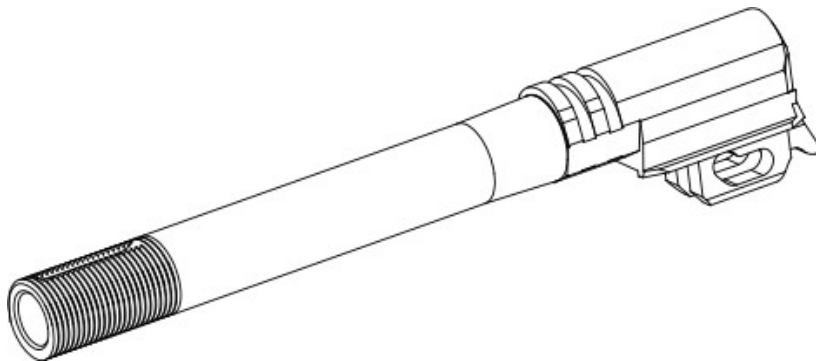

Sig Sauer P210 - 9x19 Threaded / Gewinde L=140 MM (5.5")

Caliber Kaliber	Profile Profil	Threading Gewinde	Order No. Artikelnr.	Threading Gewinde	Order No. Artikelnr.	Price Preis
9x19	Poly	1/2x28	D01-P919-140-G01	M13,5x1L	D01-P919-140-G04	D+A01
9x19	Hexa	1/2x28	D01-H919-140-G01	M13,5x1L	D01-H919-140-G04	D+A01
9x21	Poly	1/2x28	D01-P921-140-G01	M13,5x1L	D01-P921-140-G04	D+A01
7,65 Para	Hexa	1/2x28	D01-H765-140-G01	M13,5x1L	D01-H765-140-G04	D+A01

More threadings on request / Mehr Gewinde auf Anfrage

Accessories / Zubehör

	Price / Preis
Model Shark	A09
Model Shark Compact	A09
Steel Thread Protector	A08

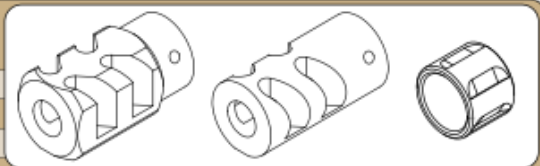

Add Custom Surface Oberflächenoptionen

	Price / Preis
PVD (Gold, Silver, Tan, Bronze, ...)	Base + A05
Sandblast / Sandgestrahlt	Base + A04
Twisted Fluted / Spiralgefütet	Base + A02
Straight Fluted / Geradegefütet	Base + A02

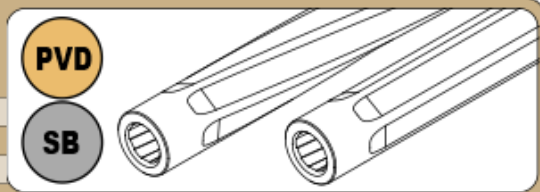

IGB BARRELS FOR P210

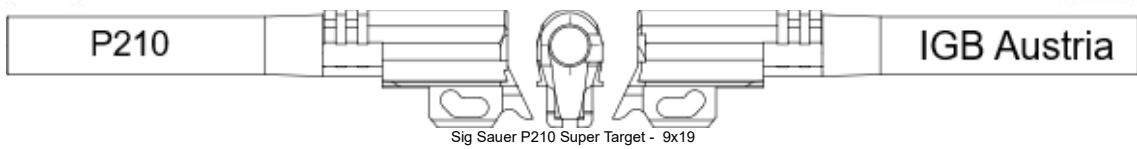

Sig Sauer P210 Super Target - 9x19 L=153 MM (6")

Order No. Artikelnr.	From Von	Inner Profile Innenprofil	To Zu	Length Länge	Price Preis
D01-P919-S156	9x19	Polygonal	9x19	156 MM	E
D01-H919-S156	9x19	Hexagonal	9x19	156 MM	E
D01-P921-S156	9x19	Polygonal	9x21	156 MM	E
D01-H765-S156	9x19	Hexagonal	7,65 Para	156 MM	E

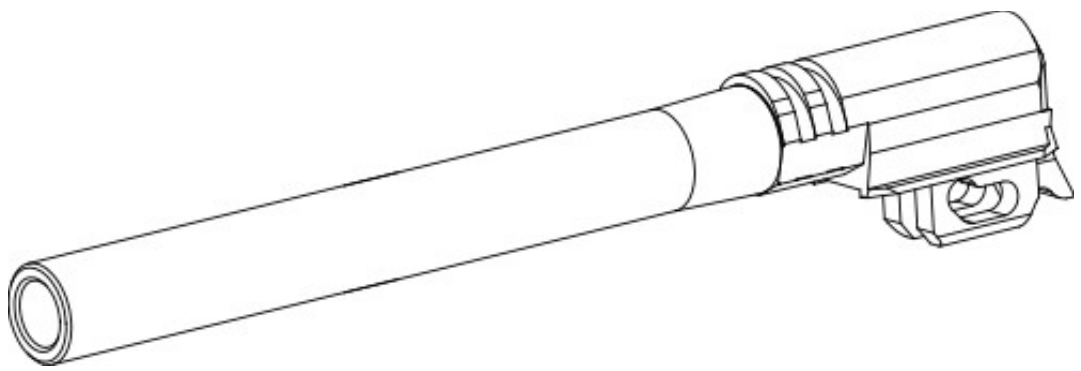

Sig Sauer P210 Super Target - 9x19 Threaded / Gewinde L=170 MM (6.7")

Caliber Kaliber	Profile Profil	Threading Gewinde	Order No. Artikelnr.	Threading Gewinde	Order No. Artikelnr.	Price Preis
9x19	Poly	1/2x28	D01-P919-170-G01	M13,5x1L	D01-P919-170-G04	E+A01
9x19	Hexa	1/2x28	D01-H919-170-G01	M13,5x1L	D01-H919-170-G04	E+A01
9x21	Poly	1/2x28	D01-P921-170-G01	M13,5x1L	D01-P921-170-G04	E+A01
7,65 Para	Hexa	1/2x28	D01-H765-170-G01	M13,5x1L	D01-H765-170-G04	E+A01

More threadings on request / Mehr Gewinde auf Anfrage

Additional Options / Zusätzliche Optionen		Price / Preis
Straight Fluted / Geradegefütet		Base +A03
Twisted Fluted / Spiralgefütet		Base +A03
3 Muzzleports / 3 Mündungsschlitze		Base +A02
5 Muzzleports / 5 Mündungsschlitze		Base +A02

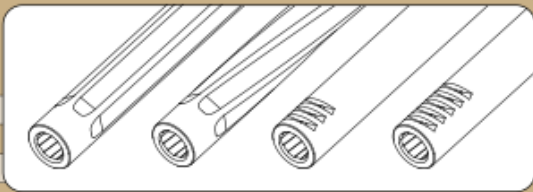

Add Custom Surface Oberflächenoptionen		Price / Preis
PVD (Gold, Silver, Tan, Bronze, ...)		Base + A05
Sandblast / Sandgestrahlt		Base +A04
Twisted Fluted / Spiralgefütet		Base +A02
Straight Fluted / Geradegefütet		Base +A02

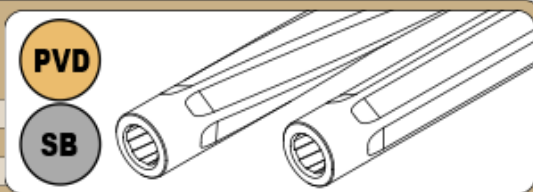

IGB BARRELS FOR 1911 & CLONES

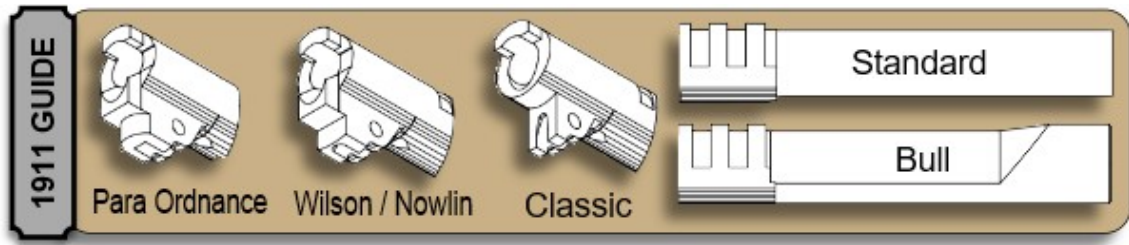

1911

E01	Classic .45
E02	Classic .40
E03	Classic 9 mm
E04	Bull .45
E05	Bull .40
E06	Bull 9 mm
E07	Classic + Wilson / Nowlin .45
E08	Classic + Wilson / Nowlin .40
E09	Classic + Wilson / Nowlin .9 mm
E10	Bull + Wilson / Nowlin .45
E11	Bull + Wilson / Nowlin .40
E12	Bull + Wilson / Nowlin 9 mm
E13	Classic + Para Ordnance .45
E14	Classic + Para Ordnance .40
E15	Classic + Para Ordnance 9 mm
E16	Bull+ Para Ordnance .45
E17	Bull+ Para Ordnance .40
E18	Bull+ Para Ordnance 9 mm
Semi-Drop in	1911, Colt, STI. SPS, Grizzly, Les Baer

IGB BARRELS FOR 1911

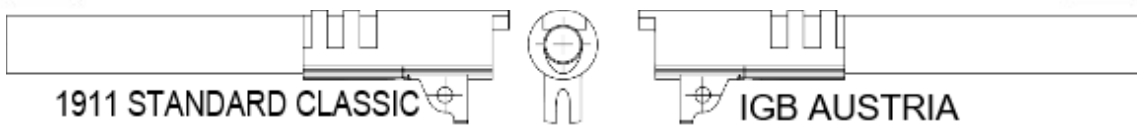

1911 Standard Classic .45 ACP L=128 MM (5.00")

Order No. Artikelnr.	From Von	Inner Profile Innenprofil	To Zu	Length Länge	Price Preis
E01-45-S128	.45 ACP	Hexagonal	.45ACP	128 MM	C
E01-40-S128	.45 ACP	Hexagonal	.40 S&W	128 MM	C
E01-400-S128	.45 ACP	Hexagonal	.400 CorBon	128 MM	C
E01-H357-S128	.45 ACP	Hexagonal	.357 Sig	128 MM	C
E01-P357-S128	.45 ACP	Polygonal	.357 Sig	128 MM	C
E01-H925-S128	.45 ACP	Hexagonal	9x25 Dillon	128 MM	C
E01-P925-S128	.45 ACP	Polygonal	9x25 Dillon	128 MM	C

1911 Standard Classic .45 ACP L=153 MM (6.00")

Order No. Artikelnr.	From Von	Inner Profile Innenprofil	To Zu	Length Länge	Price Preis
E01-45-153	.45 ACP	Hexagonal	.45ACP	153 MM	C
E01-40-153	.45 ACP	Hexagonal	.40 S&W	153 MM	C
E01-400-153	.45 ACP	Hexagonal	.400 CorBon	128 MM	C
E01-H357-153	.45 ACP	Hexagonal	.357 Sig	153 MM	C
E01-P357-153	.45 ACP	Polygonal	.357 Sig	153 MM	C
E01-H925-153	.45 ACP	Hexagonal	9x25 Dillon	153 MM	C
E01-P925-153	.45 ACP	Polygonal	9x25 Dillon	153 MM	C

Options for all types;
Optionen für alle Varianten;

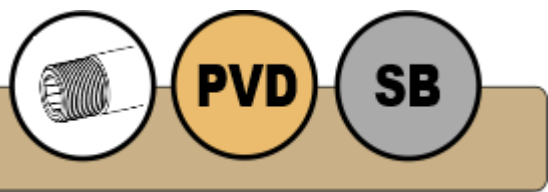

Order No.+ Artikelnr. +	Type Art	Price Preis
XXXX-G	Gewinde / Thread	C+A01
XXXX-PVD	Coating / Beschichtung	C+A05
XXXX-SB	Surface Sandblast / Oberfläche Sandgestraht	C+A04

IGB BARRELS FOR 1911



1911 Standard Classic .40 S&W L=128 MM (5.00“)

Order No. Artikelnr.	From Von	Inner Profile Innenprofil	To Zu	Length Länge	Price Preis
E02-40-S128	.40 S&W	Hexagonal	.40 S&W	128 MM	C
E02-H357-S128	.40 S&W	Hexagonal	.357 Sig	128 MM	C
E02-P357-S128	.40 S&W	Polygonal	.357 Sig	128 MM	C
E02-H919-S128	.40 S&W	Hexagonal	9x19	128 MM	C
E02-P919-S128	.40 S&W	Polygonal	9x19	128 MM	C
E02-H921-S128	.40 S&W	Hexagonal	9x21	128 MM	C
E02-P921-S128	.40 S&W	Polygonal	9x21	128 MM	C
E02-H925-S128	.40 S&W	Hexagonal	9x25 Dillon	128 MM	C
E02-P925-S128	.40 S&W	Polygonal	9x25 Dillon	128 MM	C

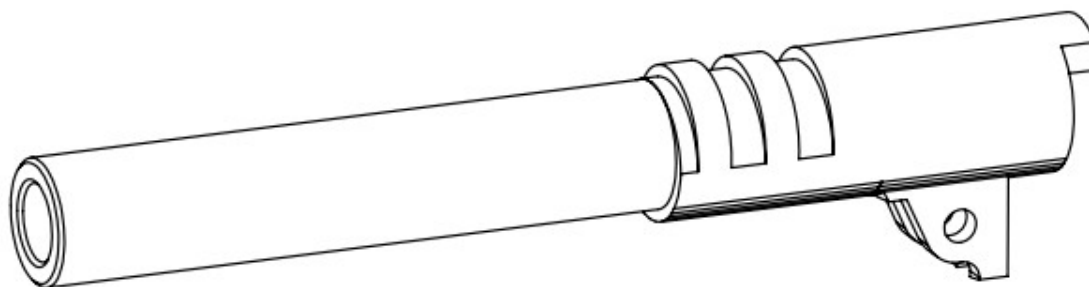

1911 Standard Classic .40 S&W L=153 MM (6.00“)

Order No. Artikelnr.	From Von	Inner Profile Innenprofil	To Zu	Length Länge	Price Preis
E02-40-153	.40 S&W	Hexagonal	.40 S&W	153 MM	C
E02-H357-153	.40 S&W	Hexagonal	.357 Sig	153 MM	C
E02-P357-153	.40 S&W	Polygonal	.357 Sig	153 MM	C
E02-H919-153	.40 S&W	Hexagonal	9x19	153 MM	C
E02-P919-153	.40 S&W	Polygonal	9x19	153 MM	C
E02-H921-153	.40 S&W	Hexagonal	9x21	153 MM	C
E02-P921-153	.40 S&W	Polygonal	9x21	153 MM	C
E02-H925-153	.40 S&W	Hexagonal	9x25 Dillon	153 MM	C
E02-P925-153	.40 S&W	Polygonal	9x25 Dillon	153 MM	C

IGB BARRELS FOR 1911

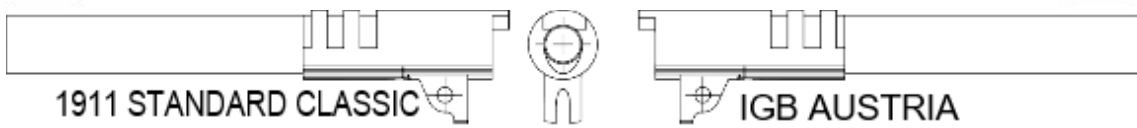

1911 Standard Classic 9x19 L=128 MM (5.00")

Order No. Artikelnr.	From Von	Inner Profile Innenprofil	To Zu	Length Länge	Price Preis
E03-H919-S128	9x19	Hexagonal	9x19	128 MM	C
E03-P919-S128	9x19	Polygonal	9x19	128 MM	C
E03-H921-S128	9x19	Hexagonal	9x21	128 MM	C
E03-P921-S128	9x19	Polygonal	9x21	128 MM	C

1911 Standard Classic 9x19 L=153 MM (6.00")

Order No. Artikelnr.	From Von	Inner Profile Innenprofil	To Zu	Length Länge	Price Preis
E02-H919-153	9x19	Hexagonal	9x19	153 MM	C
E02-P919-153	9x19	Polygonal	9x19	153 MM	C
E02-H921-153	9x19	Hexagonal	9x21	153 MM	C
E02-P921-153	9x19	Polygonal	9x21	153 MM	C

Options for all types;
Optionen für alle Varianten;

Order No.+ Artikelnr. +	Type Art	Price Preis
XXXX-G	Gewinde / Thread	C+A01
XXXX-PVD	Coating / Beschichtung	C+A05
XXXX-SB	Surface Sandblast / Oberfläche Sandgestraht	C+A04

**MORE CALIBERS ON REQUEST; SUCH AS; .38 SUPER, 7,65 Para
MEHR KALIBER AUF ANFRAGE WIE z.B.; .38 SUPER, 7,65 Para**

IGB BARRELS FOR 1911

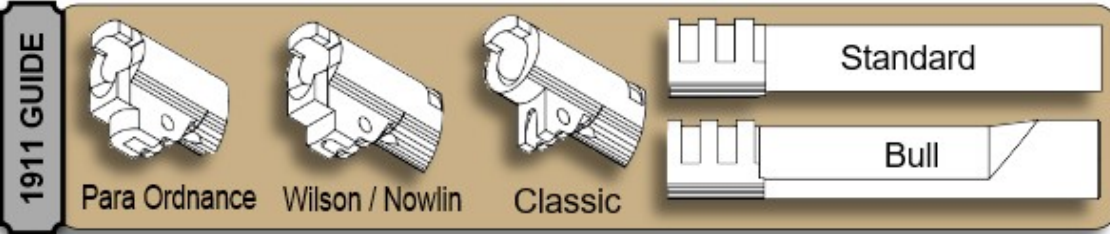

1911 Bull Classic .45 ACP L=128 MM (5.00")

Order No. Artikelnr.	From Von	Inner Profile Innenprofil	To Zu	Length Länge	Price Preis
E04-45-S128	.45ACP	Hexagonal	.45ACP	128 MM	C
E04-40-S128	.45ACP	Hexagonal	.40 S&W	128 MM	C
E04-400-S128	.45ACP	Hexagonal	.400 CorBon	128 MM	C
E04-H357-S128	.45ACP	Hexagonal	.357 Sig	128 MM	C
E04-P357-S128	.45ACP	Polygonal	.357 Sig	128 MM	C
E04-H925-S128	.45ACP	Hexagonal	9x25 Dillon	128 MM	C
E04-P925-S128	.45ACP	Polygonal	9x25 Dillon	128 MM	C

1911 Bull Classic .45 ACP L=153 MM (6.00")

Order No. Artikelnr.	From Von	Inner Profile Innenprofil	To Zu	Length Länge	Price Preis
E04-45-153	.45ACP	Hexagonal	.45ACP	153 MM	C
E04-40-153	.45ACP	Hexagonal	.40 S&W	153 MM	C
E04-400-153	.45ACP	Hexagonal	.400 CorBon	128 MM	C
E04-H357-153	.45ACP	Hexagonal	.357 Sig	153 MM	C
E04-P357-153	.45ACP	Polygonal	.357 Sig	153 MM	C
E04-H925-153	.45ACP	Hexagonal	9x25 Dillon	153 MM	C
E04-P925-153	.45ACP	Polygonal	9x25 Dillon	153 MM	C

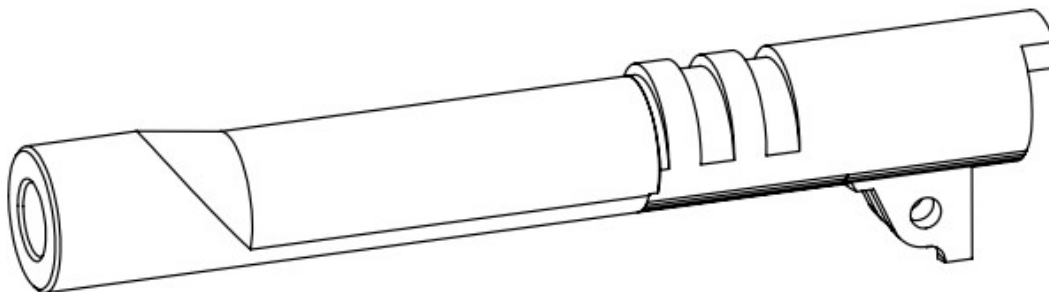

IGB BARRELS FOR 1911

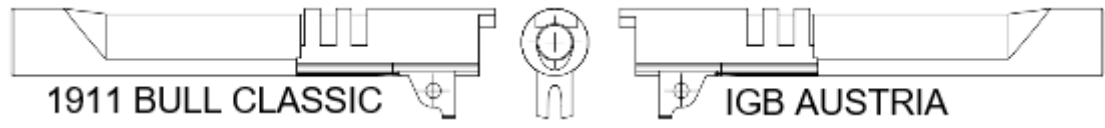

1911 Bull Classic .40 S&W L=128 MM (5.00")

Order No. Artikelnr.	From Von	Inner Profile Innenprofil	To Zu	Length Länge	Price Preis
E05-40-S128	.40 S&W	Hexagonal	.40 S&W	128 MM	C
E05-H357-S128	.40 S&W	Hexagonal	.357 Sig	128 MM	C
E05-P357-S128	.40 S&W	Polygonal	.357 Sig	128 MM	C
E05-H919-S128	.40 S&W	Hexagonal	9x19	128 MM	C
E05-P919-S128	.40 S&W	Polygonal	9x19	128 MM	C
E05-H921-S128	.40 S&W	Hexagonal	9x21	128 MM	C
E05-P921-S128	.40 S&W	Polygonal	9x21	128 MM	C
E05-H925-S128	.40 S&W	Hexagonal	9x25 Dillon	128 MM	C
E05-P925-S128	.40 S&W	Polygonal	9x25 Dillon	128 MM	C

1911 Bull Classic .40 S&W L=153 MM (6.00")

Order No. Artikelnr.	From Von	Inner Profile Innenprofil	To Zu	Length Länge	Price Preis
E05-40-153	.40 S&W	Hexagonal	.40 S&W	153 MM	C
E05-H357-153	.40 S&W	Hexagonal	.357 Sig	153 MM	C
E05-P357-153	.40 S&W	Polygonal	.357 Sig	153 MM	C
E05-H919-153	.40 S&W	Hexagonal	9x19	153 MM	C
E05-P919-153	.40 S&W	Polygonal	9x19	153 MM	C
E05-H921-153	.40 S&W	Hexagonal	9x21	153 MM	C
E05-P921-153	.40 S&W	Polygonal	9x21	153 MM	C
E05-H925-153	.40 S&W	Hexagonal	9x25 Dillon	153 MM	C
E05-P925-153	.40 S&W	Polygonal	9x25 Dillon	153 MM	C

Options for all types;
Optionen für alle Varianten;

IGB BARRELS FOR 1911



1911 Bull Classic 9x19 L=128 MM (5.00“)

Order No. Artikelnr.	From Von	Inner Profile Innenprofil	To Zu	Length Länge	Price Preis
E06-H919-S128	9x19	Hexagonal	9x19	128 MM	C
E06-P919-S128	9x19	Polygonal	9x19	128 MM	C
E06-H921-S128	9x19	Hexagonal	9x21	128 MM	C
E06-P921-S128	9x19	Polygonal	9x21	128 MM	C

1911 Bull Classic 9x19 L=153 MM (6.00“)

Order No. Artikelnr.	From Von	Inner Profile Innenprofil	To Zu	Length Länge	Price Preis
E06-H919-153	9x19	Hexagonal	9x19	153 MM	C
E06-P919-153	9x19	Polygonal	9x19	153 MM	C
E06-H921-153	9x19	Hexagonal	9x21	153 MM	C
E06-P921-153	9x19	Polygonal	9x21	153 MM	C

Options for all types;
Optionen für alle Varianten;

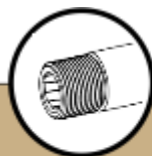

PVD

SB

Order No.+ Artikelnr. +	Type Art	Price Preis
XXXX-G	Gewinde / Thread	C+A01
XXXX-PVD	Coating / Beschichtung	C+A05
XXXX-SB	Surface Sandblast / Oberfläche Sandgestraht	C+A04

**MORE CALIBERS ON REQUEST; SUCH AS; .38 SUPER, 7,65 Para
MEHR KALIBER AUF ANFRAGE WIE z.B.; .38 SUPER, 7,65 Para**

IGB BARRELS FOR 1911



1911 Standard Wilson + Nowlin .45 ACP L=128 MM (5.00“)

Order No. Artikelnr.	From Von	Inner Profile Innenprofil	To Zu	Length Länge	Price Preis
E07-45-S128	.45 ACP	Hexagonal	.45ACP	128 MM	C
E07-40-S128	.45 ACP	Hexagonal	.40 S&W	128 MM	C
E07-400-S128	.45 ACP	Hexagonal	.400 CorBon	128 MM	C
E07-H357-S128	.45 ACP	Hexagonal	.357 Sig	128 MM	C
E07-P357-S128	.45 ACP	Polygonal	.357 Sig	128 MM	C
E07-H925-S128	.45 ACP	Hexagonal	9x25 Dillon	128 MM	C
E07-P925-S128	.45 ACP	Polygonal	9x25 Dillon	128 MM	C

1911 Standard Wilson + Nowlin .45 ACP L=153 MM (6.00“)

Order No. Artikelnr.	From Von	Inner Profile Innenprofil	To Zu	Length Länge	Price Preis
E07-45-153	.45 ACP	Hexagonal	.45ACP	153 MM	C
E07-40-153	.45 ACP	Hexagonal	.40 S&W	153 MM	C
E07-400-153	.45 ACP	Hexagonal	.400 CorBon	128 MM	C
E07-H357-153	.45 ACP	Hexagonal	.357 Sig	153 MM	C
E07-P357-153	.45 ACP	Polygonal	.357 Sig	153 MM	C
E07-H925-153	.45 ACP	Hexagonal	9x25 Dillon	153 MM	C
E07-P925-153	.45 ACP	Polygonal	9x25 Dillon	153 MM	C

Options for all types;
Optionen für alle Varianten;

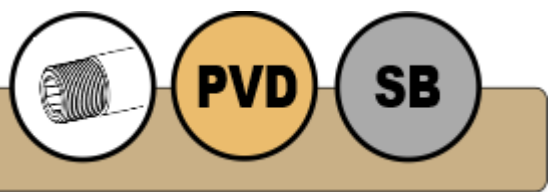

Order No.+ Artikelnr. +	Type Art	Price Preis
XXXX-G	Gewinde / Thread	C+A01
XXXX-PVD	Coating / Beschichtung	C+A05
XXXX-SB	Surface Sandblast / Oberfläche Sandgestraht	C+A04

IGB BARRELS FOR 1911

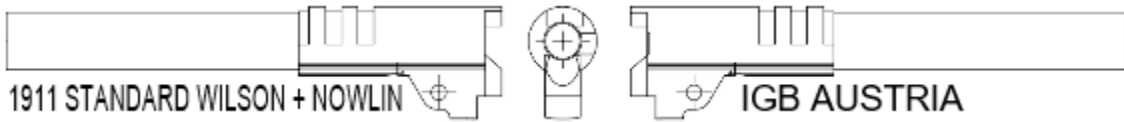

1911 Standard Wilson + Nowlin .40 S&W L=128 MM (5.00")

Order No. Artikelnr.	From Von	Inner Profile Innenprofil	To Zu	Length Länge	Price Preis
E08-40-S128	.40 S&W	Hexagonal	.40 S&W	128 MM	C
E08-H357-S128	.40 S&W	Hexagonal	.357 Sig	128 MM	C
E08-P357-S128	.40 S&W	Polygonal	.357 Sig	128 MM	C
E08-H919-S128	.40 S&W	Hexagonal	9x19	128 MM	C
E08-P919-S128	.40 S&W	Polygonal	9x19	128 MM	C
E08-H921-S128	.40 S&W	Hexagonal	9x21	128 MM	C
E08-P921-S128	.40 S&W	Polygonal	9x21	128 MM	C
E08-H925-S128	.40 S&W	Hexagonal	9x25 Dillon	128 MM	C
E08-P925-S128	.40 S&W	Polygonal	9x25 Dillon	128 MM	C

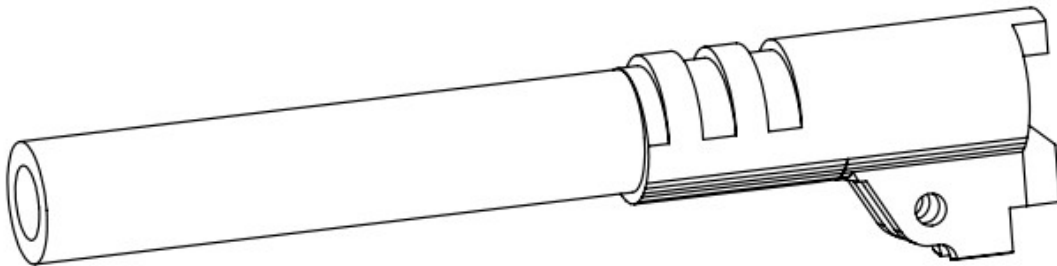

1911 Standard Wilson + Nowlin .40 S&W L=153 MM (6.00")

Order No. Artikelnr.	From Von	Inner Profile Innenprofil	To Zu	Length Länge	Price Preis
E08-40-153	.40 S&W	Hexagonal	.40 S&W	153 MM	C
E08-H357-153	.40 S&W	Hexagonal	.357 Sig	153 MM	C
E08-P357-153	.40 S&W	Polygonal	.357 Sig	153 MM	C
E08-H919-153	.40 S&W	Hexagonal	9x19	153 MM	C
E08-P919-153	.40 S&W	Polygonal	9x19	153 MM	C
E08-H921-153	.40 S&W	Hexagonal	9x21	153 MM	C
E08-P921-153	.40 S&W	Polygonal	9x21	153 MM	C
E08-H925-153	.40 S&W	Hexagonal	9x25 Dillon	153 MM	C
E08-P925-153	.40 S&W	Polygonal	9x25 Dillon	153 MM	C

IGB BARRELS FOR 1911





1911 Standard Wilson + Nowlin 9x19 L=128 MM (5.00")

Order No. Artikelnr.	From Von	Inner Profile Innenprofil	To Zu	Length Länge	Price Preis
E09-H919-S128	9x19	Hexagonal	9x19	128 MM	C
E09-P919-S128	9x19	Polygonal	9x19	128 MM	C
E09-H921-S128	9x19	Hexagonal	9x21	128 MM	C
E09-P921-S128	9x19	Polygonal	9x21	128 MM	C

1911 Standard Wilson + Nowlin 9x19 L=153 MM (6.00")

Order No. Artikelnr.	From Von	Inner Profile Innenprofil	To Zu	Length Länge	Price Preis
E09-H919-153	9x19	Hexagonal	9x19	153 MM	C
E09-P919-153	9x19	Polygonal	9x19	153 MM	C
E09-H921-153	9x19	Hexagonal	9x21	153 MM	C
E09-P921-153	9x19	Polygonal	9x21	153 MM	C

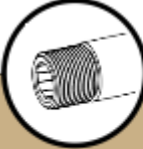
Options for all types;
Optionen für alle Varianten;

Order No.+ Artikelnr. +	Type Art	Price Preis
XXXX-G	Gewinde / Thread	C+A01
XXXX-PVD	Coating / Beschichtung	C+A05
XXXX-SB	Surface Sandblast / Oberfläche Sandgestraht	C+A04

**MORE CALIBERS ON REQUEST; SUCH AS; .38 SUPER, 7,65 Para
MEHR KALIBER AUF ANFRAGE WIE z.B.; .38 SUPER, 7,65 Para**

IGB BARRELS FOR 1911



1911 Bull Wilson + Nowlin .45 ACP L=128 MM (5.00")

Order No. Artikelnr.	From Von	Inner Profile Innenprofil	To Zu	Length Länge	Price Preis
E10-45-S128	.45ACP	Hexagonal	.45ACP	128 MM	C
E10-40-S128	.45ACP	Hexagonal	.40 S&W	128 MM	C
E10-400-S128	.45ACP	Hexagonal	.400 CorBon	128 MM	C
E10-H357-S128	.45ACP	Hexagonal	.357 Sig	128 MM	C
E10-P357-S128	.45ACP	Polygonal	.357 Sig	128 MM	C
E10-H925-S128	.45ACP	Hexagonal	9x25 Dillon	128 MM	C
E10-P925-S128	.45ACP	Polygonal	9x25 Dillon	128 MM	C

1911 Bull Wilson + Nowlin .45 ACP L=153 MM (6.00")

Order No. Artikelnr.	From Von	Inner Profile Innenprofil	To Zu	Length Länge	Price Preis
E10-45-153	.45ACP	Hexagonal	.45ACP	153 MM	C
E10-40-153	.45ACP	Hexagonal	.40 S&W	153 MM	C
E10-400-153	.45ACP	Hexagonal	.400 CorBon	128 MM	C
E10-H357-153	.45ACP	Hexagonal	.357 Sig	153 MM	C
E10-P357-153	.45ACP	Polygonal	.357 Sig	153 MM	C
E10-H925-153	.45ACP	Hexagonal	9x25 Dillon	153 MM	C
E10-P925-153	.45ACP	Polygonal	9x25 Dillon	153 MM	C

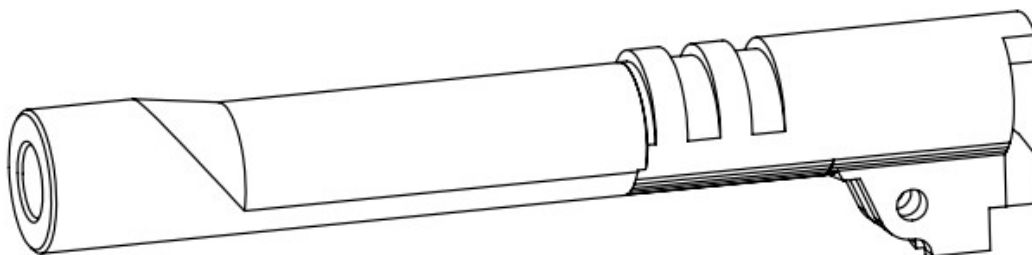

IGB BARRELS FOR 1911

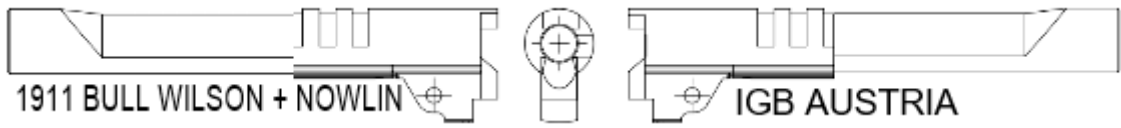

1911 Bull Wilson + Nowlin .40 S&W L=128 MM (5.00")

Order No. Artikelnr.	From Von	Inner Profile Innenprofil	To Zu	Length Länge	Price Preis
E11-40-S128	.40 S&W	Hexagonal	.40 S&W	128 MM	C
E11-H357-S128	.40 S&W	Hexagonal	.357 Sig	128 MM	C
E11-P357-S128	.40 S&W	Polygonal	.357 Sig	128 MM	C
E11-H919-S128	.40 S&W	Hexagonal	9x19	128 MM	C
E11-P919-S128	.40 S&W	Polygonal	9x19	128 MM	C
E11-H921-S128	.40 S&W	Hexagonal	9x21	128 MM	C
E11-P921-S128	.40 S&W	Polygonal	9x21	128 MM	C
E11-H925-S128	.40 S&W	Hexagonal	9x25 Dillon	128 MM	C
E11-P925-S128	.40 S&W	Polygonal	9x25 Dillon	128 MM	C

1911 Bull Wilson + Nowlin .40 S&W L=153 MM (6.00")

Order No. Artikelnr.	From Von	Inner Profile Innenprofil	To Zu	Length Länge	Price Preis
E11-40-153	.40 S&W	Hexagonal	.40 S&W	153 MM	C
E11-H357-153	.40 S&W	Hexagonal	.357 Sig	153 MM	C
E11-P357-153	.40 S&W	Polygonal	.357 Sig	153 MM	C
E11-H919-153	.40 S&W	Hexagonal	9x19	153 MM	C
E11-P919-153	.40 S&W	Polygonal	9x19	153 MM	C
E11-H921-153	.40 S&W	Hexagonal	9x21	153 MM	C
E11-P921-153	.40 S&W	Polygonal	9x21	153 MM	C
E11-H925-153	.40 S&W	Hexagonal	9x25 Dillon	153 MM	C
E11-P925-153	.40 S&W	Polygonal	9x25 Dillon	153 MM	C

Options for all types;
Optionen für alle Varianten;

IGB BARRELS FOR 1911

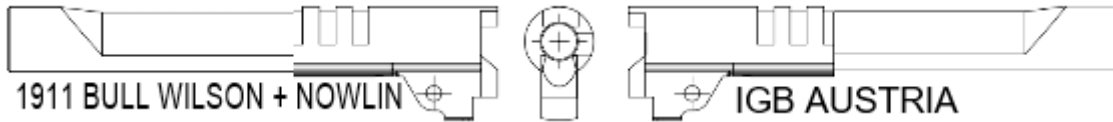

1911 Bull Wilson + Nowlin 9x19 L=128 MM (5.00")

Order No. Artikelnr.	From Von	Inner Profile Innenprofil	To Zu	Length Länge	Price Preis
E12-H919-S128	9x19	Hexagonal	9x19	128 MM	C
E12-P919-S128	9x19	Polygonal	9x19	128 MM	C
E12-H921-S128	9x19	Hexagonal	9x21	128 MM	C
E12-P921-S128	9x19	Polygonal	9x21	128 MM	C

1911 Bull Wilson + Nowlin 9x19 L=153 MM (6.00")

Order No. Artikelnr.	From Von	Inner Profile Innenprofil	To Zu	Length Länge	Price Preis
E12-H919-153	9x19	Hexagonal	9x19	153 MM	C
E12-P919-153	9x19	Polygonal	9x19	153 MM	C
E12-H921-153	9x19	Hexagonal	9x21	153 MM	C
E12-P921-153	9x19	Polygonal	9x21	153 MM	C

Options for all types;
Optionen für alle Varianten;

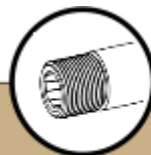

PVD

SB

Order No.+ Artikelnr. +	Type Art	Price Preis
XXXX-G	Gewinde / Thread	C+A01
XXXX-PVD	Coating / Beschichtung	C+A05
XXXX-SB	Surface Sandblast / Oberfläche Sandgestraht	C+A04

**MORE CALIBERS ON REQUEST; SUCH AS; .38 SUPER, 7,65 Para
MEHR KALIBER AUF ANFRAGE WIE z.B.; .38 SUPER, 7,65 Para**

IGB BARRELS FOR 1911



1911 Standard Para Ordnance .45 ACP L=128 MM (5.00“)

Order No. Artikelnr.	From Von	Inner Profile Innenprofil	To Zu	Length Länge	Price Preis
E13-45-S128	.45 ACP	Hexagonal	.45ACP	128 MM	C
E13-40-S128	.45 ACP	Hexagonal	.40 S&W	128 MM	C
E13-400-S128	.45 ACP	Hexagonal	.400 CorBon	128 MM	C
E13-H357-S128	.45 ACP	Hexagonal	.357 Sig	128 MM	C
E13-P357-S128	.45 ACP	Polygonal	.357 Sig	128 MM	C
E13-H925-S128	.45 ACP	Hexagonal	9x25 Dillon	128 MM	C
E13-P925-S128	.45 ACP	Polygonal	9x25 Dillon	128 MM	C

1911 Standard Para Ordnance .45 ACP L=153 MM (6.00“)

Order No. Artikelnr.	From Von	Inner Profile Innenprofil	To Zu	Length Länge	Price Preis
E13-45-153	.45 ACP	Hexagonal	.45ACP	153 MM	C
E13-40-153	.45 ACP	Hexagonal	.40 S&W	153 MM	C
E13-400-153	.45 ACP	Hexagonal	.400 CorBon	128 MM	C
E13-H357-153	.45 ACP	Hexagonal	.357 Sig	153 MM	C
E13-P357-153	.45 ACP	Polygonal	.357 Sig	153 MM	C
E13-H925-153	.45 ACP	Hexagonal	9x25 Dillon	153 MM	C
E13-P925-153	.45 ACP	Polygonal	9x25 Dillon	153 MM	C

Options for all types;
Optionen für alle Varianten;

Order No.+ Artikelnr. +	Type Art	Price Preis
XXXX-G	Gewinde / Thread	C+A01
XXXX-PVD	Coating / Beschichtung	C+A05
XXXX-SB	Surface Sandblast / Oberfläche Sandgestraht	C+A04

IGB BARRELS FOR 1911



1911 Standard Para Ordnance .40 S&W L=128 MM (5.00")

Order No. Artikelnr.	From Von	Inner Profile Innenprofil	To Zu	Length Länge	Price Preis
E14-40-S128	.40 S&W	Hexagonal	.40 S&W	128 MM	C
E14-H357-S128	.40 S&W	Hexagonal	.357 Sig	128 MM	C
E14-P357-S128	.40 S&W	Polygonal	.357 Sig	128 MM	C
E14-H919-S128	.40 S&W	Hexagonal	9x19	128 MM	C
E14-P919-S128	.40 S&W	Polygonal	9x19	128 MM	C
E14-H921-S128	.40 S&W	Hexagonal	9x21	128 MM	C
E14-P921-S128	.40 S&W	Polygonal	9x21	128 MM	C
E14-H925-S128	.40 S&W	Hexagonal	9x25 Dillon	128 MM	C
E14-P925-S128	.40 S&W	Polygonal	9x25 Dillon	128 MM	C

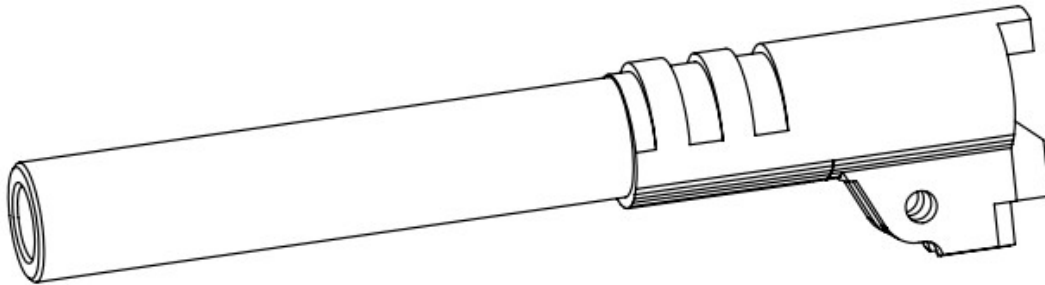

1911 Standard Para Ordnance .40 S&W L=153 MM (6.00")

Order No. Artikelnr.	From Von	Inner Profile Innenprofil	To Zu	Length Länge	Price Preis
E14-40-153	.40 S&W	Hexagonal	.40 S&W	153 MM	C
E14-H357-153	.40 S&W	Hexagonal	.357 Sig	153 MM	C
E14-P357-153	.40 S&W	Polygonal	.357 Sig	153 MM	C
E14-H919-153	.40 S&W	Hexagonal	9x19	153 MM	C
E14-P919-153	.40 S&W	Polygonal	9x19	153 MM	C
E14-H921-153	.40 S&W	Hexagonal	9x21	153 MM	C
E14-P921-153	.40 S&W	Polygonal	9x21	153 MM	C
E14-H925-153	.40 S&W	Hexagonal	9x25 Dillon	153 MM	C
E14-P925-153	.40 S&W	Polygonal	9x25 Dillon	153 MM	C

IGB BARRELS FOR 1911



1911 Standard Para Ordnance 9x19 L=128 MM (5.00")

Order No. Artikelnr.	From Von	Inner Profile Innenprofil	To Zu	Length Länge	Price Preis
E15-H919-S128	9x19	Hexagonal	9x19	128 MM	C
E15-P919-S128	9x19	Polygonal	9x19	128 MM	C
E15-H921-S128	9x19	Hexagonal	9x21	128 MM	C
E15-P921-S128	9x19	Polygonal	9x21	128 MM	C

1911 Standard Para Ordnance 9x19 L=153 MM (6.00")

Order No. Artikelnr.	From Von	Inner Profile Innenprofil	To Zu	Length Länge	Price Preis
E15-H919-153	9x19	Hexagonal	9x19	153 MM	C
E15-P919-153	9x19	Polygonal	9x19	153 MM	C
E15-H921-153	9x19	Hexagonal	9x21	153 MM	C
E15-P921-153	9x19	Polygonal	9x21	153 MM	C

Options for all types;
Optionen für alle Varianten;

Order No.+ Artikelnr. +	Type Art	Price Preis
XXXX-G	Gewinde / Thread	C+A01
XXXX-PVD	Coating / Beschichtung	C+A05
XXXX-SB	Surface Sandblast / Oberfläche Sandgestraht	C+A04

**MORE CALIBERS ON REQUEST; SUCH AS; .38 SUPER, 7,65 Para
MEHR KALIBER AUF ANFRAGE WIE z.B.; .38 SUPER, 7,65 Para**

IGB BARRELS FOR 1911

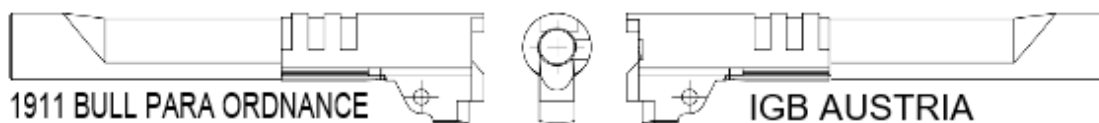

1911 BULL PARA ORDNANCE

IGB AUSTRIA

1911 GUIDE

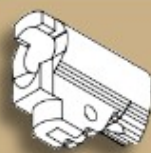

Para Ordnance

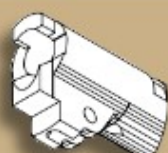

Wilson / Nowlin

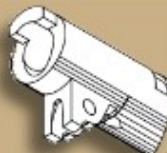

Classic



Standard

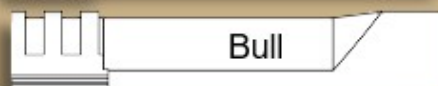

Bull

1911 Bull Para Ordnance .45 ACP L=128 MM (5.00“)

Order No. Artikelnr.	From Von	Inner Profile Innenprofil	To Zu	Length Länge	Price Preis
E16-45-S128	.45ACP	Hexagonal	.45ACP	128 MM	C
E16-40-S128	.45ACP	Hexagonal	.40 S&W	128 MM	C
E16-400-S128	.45ACP	Hexagonal	.400 CorBon	128 MM	C
E16-H357-S128	.45ACP	Hexagonal	.357 Sig	128 MM	C
E16-P357-S128	.45ACP	Polygonal	.357 Sig	128 MM	C
E16-H925-S128	.45ACP	Hexagonal	9x25 Dillon	128 MM	C
E16-P925-S128	.45ACP	Polygonal	9x25 Dillon	128 MM	C

1911 Bull Para Ordnance .45 ACP L=153 MM (6.00“)

Order No. Artikelnr.	From Von	Inner Profile Innenprofil	To Zu	Length Länge	Price Preis
E16-45-153	.45ACP	Hexagonal	.45ACP	153 MM	C
E16-40-153	.45ACP	Hexagonal	.40 S&W	153 MM	C
E16-400-153	.45ACP	Hexagonal	.400 CorBon	128 MM	C
E16-H357-153	.45ACP	Hexagonal	.357 Sig	153 MM	C
E16-P357-153	.45ACP	Polygonal	.357 Sig	153 MM	C
E16-H925-153	.45ACP	Hexagonal	9x25 Dillon	153 MM	C
E16-P925-153	.45ACP	Polygonal	9x25 Dillon	153 MM	C

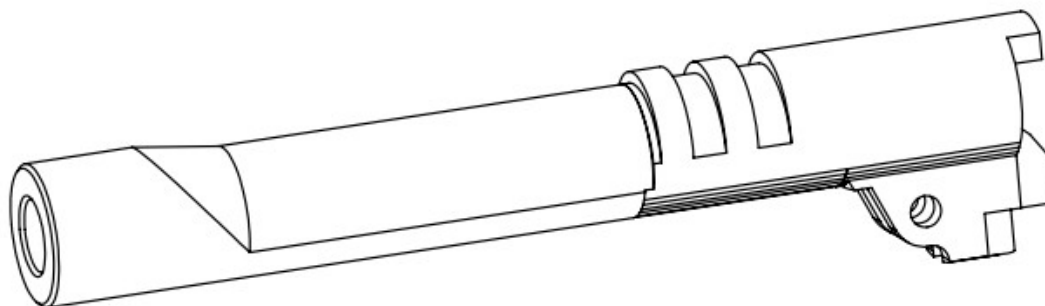

IGB BARRELS FOR 1911



1911 Bull Para Ordnance .40 S&W L=128 MM (5.00")

Order No. Artikelnr.	From Von	Inner Profile Innenprofil	To Zu	Length Länge	Price Preis
E17-40-S128	.40 S&W	Hexagonal	.40 S&W	128 MM	C
E17-H357-S128	.40 S&W	Hexagonal	.357 Sig	128 MM	C
E17-P357-S128	.40 S&W	Polygonal	.357 Sig	128 MM	C
E17-H919-S128	.40 S&W	Hexagonal	9x19	128 MM	C
E17-P919-S128	.40 S&W	Polygonal	9x19	128 MM	C
E17-H921-S128	.40 S&W	Hexagonal	9x21	128 MM	C
E17-P921-S128	.40 S&W	Polygonal	9x21	128 MM	C
E17-H925-S128	.40 S&W	Hexagonal	9x25 Dillon	128 MM	C
E17-P925-S128	.40 S&W	Polygonal	9x25 Dillon	128 MM	C

1911 Bull Para Ordnance .40 S&W L=153 MM (6.00")

Order No. Artikelnr.	From Von	Inner Profile Innenprofil	To Zu	Length Länge	Price Preis
E17-40-153	.40 S&W	Hexagonal	.40 S&W	153 MM	C
E17-H357-153	.40 S&W	Hexagonal	.357 Sig	153 MM	C
E17-P357-153	.40 S&W	Polygonal	.357 Sig	153 MM	C
E17-H919-153	.40 S&W	Hexagonal	9x19	153 MM	C
E17-P919-153	.40 S&W	Polygonal	9x19	153 MM	C
E17-H921-153	.40 S&W	Hexagonal	9x21	153 MM	C
E17-P921-153	.40 S&W	Polygonal	9x21	153 MM	C
E17-H925-153	.40 S&W	Hexagonal	9x25 Dillon	153 MM	C
E17-P925-153	.40 S&W	Polygonal	9x25 Dillon	153 MM	C

Options for all types;
Optionen für alle Varianten;

IGB BARRELS FOR 1911



1911 Bull Para Ordnance 9x19 L=128 MM (5.00")

Order No. Artikelnr.	From Von	Inner Profile Innenprofil	To Zu	Length Länge	Price Preis
E18-H919-S128	9x19	Hexagonal	9x19	128 MM	C
E18-P919-S128	9x19	Polygonal	9x19	128 MM	C
E18-H921-S128	9x19	Hexagonal	9x21	128 MM	C
E18-P921-S128	9x19	Polygonal	9x21	128 MM	C

1911 Bull Para Ordnance 9x19 L=153 MM (6.00")

Order No. Artikelnr.	From Von	Inner Profile Innenprofil	To Zu	Length Länge	Price Preis
E18-H919-153	9x19	Hexagonal	9x19	153 MM	C
E18-P919-153	9x19	Polygonal	9x19	153 MM	C
E18-H921-153	9x19	Hexagonal	9x21	153 MM	C
E18-P921-153	9x19	Polygonal	9x21	153 MM	C

Options for all types;
Optionen für alle Varianten;

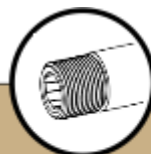

PVD

SB

Order No.+ Artikelnr. +	Type Art	Price Preis
XXXX-G	Gewinde / Thread	C+A01
XXXX-PVD	Coating / Beschichtung	C+A05
XXXX-SB	Surface Sandblast / Oberfläche Sandgestraht	C+A04

**MORE CALIBERS ON REQUEST; SUCH AS; .38 SUPER, 7,65 Para
MEHR KALIBER AUF ANFRAGE WIE z.B.; .38 SUPER, 7,65 Para**

IGB AUSTRIA - GUIDE Threadings

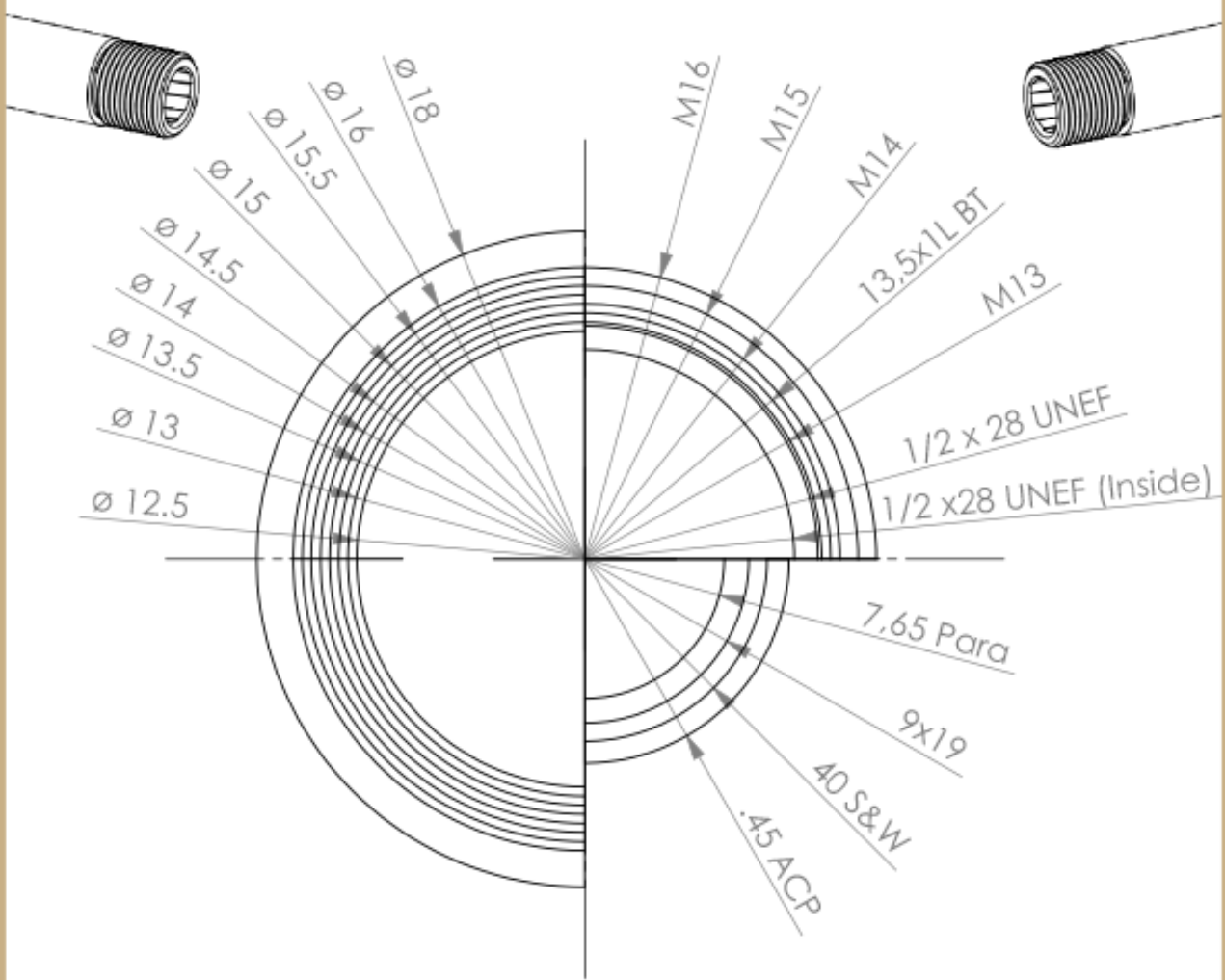

Threadings / Gewinde

Not all calibers support all threadings.
 Not all diameters support all threadings.

Example: $\frac{1}{2}$ x 28 UNEF does not fit a 12.5 mm barrel
 M15 is too big for a 14.5 mm barrel
 .45 ACP is too big for $\frac{1}{2}$ x 28 UNEF

Nicht alle Kaliber sind für gewisse Gewinde geeignet.
 Nicht alle Durchmesser sind für alle Gewinde geeignet.

Beispiel: $\frac{1}{2}$ x 28 UNEF passt nicht auf einen 12.5 mm Lauf
 M15 ist zu groß für einen 14.5 mm Lauf
 .45 ACP ist zu groß für $\frac{1}{2}$ x 28 UNEF

IGB BARRELS FOR STEYR

Steyr



IGB Austria

Barreltechnology

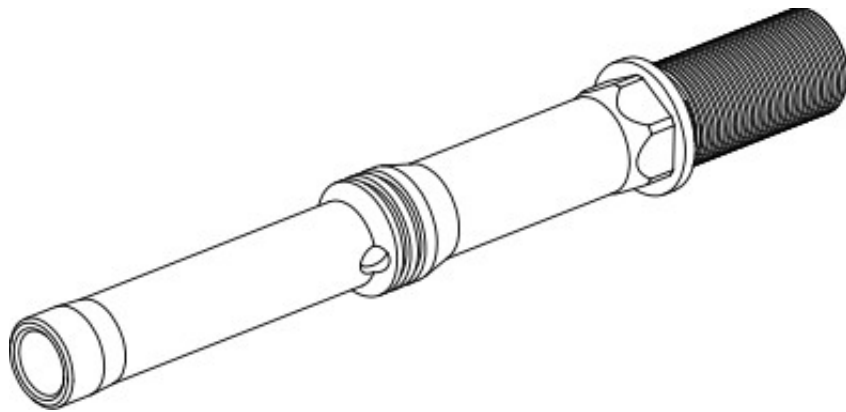
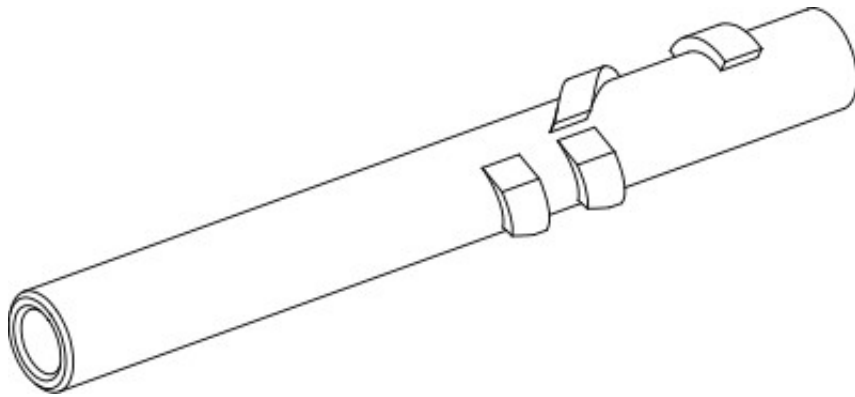

GLOCK CZ S&W SIG SAUER P210 1911

STEYR

H&K FN

ACCESSORY

GLOCK CZ S&W SIG SAUER P210 1911

STEYR

H&K FN

ACCESSORY

IGB BARRELS FOR STEYR



Steyr M12

Steyr M12 Standard Length (130 MM)

Order No. Artikelnr.	From Von	Inner Profile Innenprofil	To Zu	Length Länge	Price Preis
T07-P919-S130	9 Steyr	Polygonal	9x19	130 MM	A
T07-H919-S130	9 Steyr	Hexagonal	9x19	130 MM	A
T07-H9ST-S130	9 Steyr	Polygonal	9 Steyr	130 MM	A
T07-H765-S130	9 Steyr	Hexagonal	7,65 Para	130 MM	A

Steyr M12 Extended Length (150 MM)

Order No. Artikelnr.	From Von	Inner Profile Innenprofil	To Zu	Length Länge	Price Preis
T07-P919-150	9 Steyr	Polygonal	9x19	150 MM	R
T07-H919-150	9 Steyr	Hexagonal	9x19	150 MM	R
T07-H9ST-150	9 Steyr	Polygonal	9x21	150 MM	R
T07-H765-150	9 Steyr	Hexagonal	7,65 Para	150 MM	R

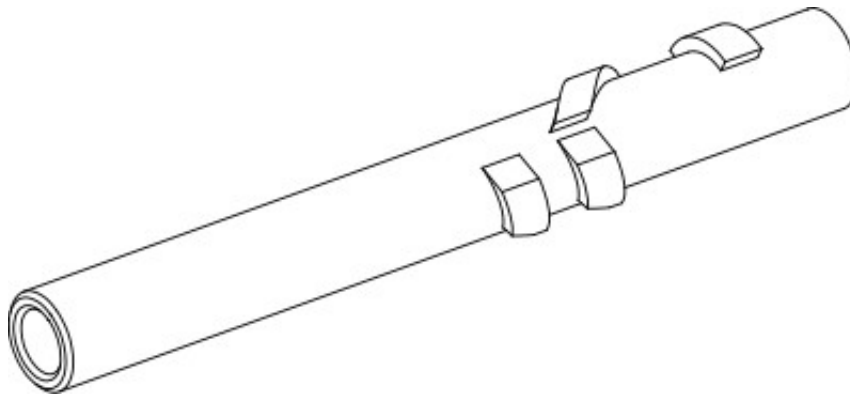

Polygonal vs Hexagonal

Polygonal is very smooth inside and therefore very gastight for high velocity.

Polygonal ist formbedingt sehr Gasdicht für hohe Geschwindigkeiten.

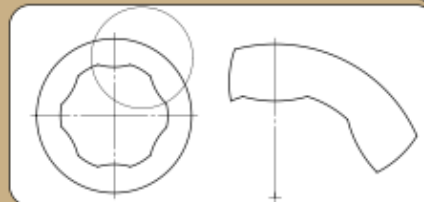
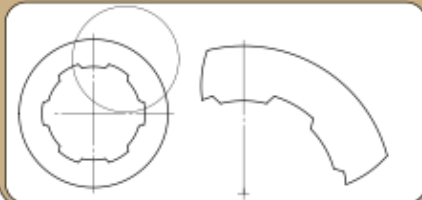

Hexagonal is the more classic approach and also well suited for pure lead.

Hexagonal ist der klassischere Ansatz und gut geeignet für reine Bleigeschoße.

IGB BARRELS FOR STEYR



Steyr GB

Steyr GB Standard Length (137 MM)

Order No. Artikelnr.	From Von	Inner Profile Innenprofil	To Zu	Length Länge	Price Preis
T08-P919-S137	9x19	Polygonal	9x19	137 MM	A
T08-H919-S137	9x19	Hexagonal	9x19	137 MM	A

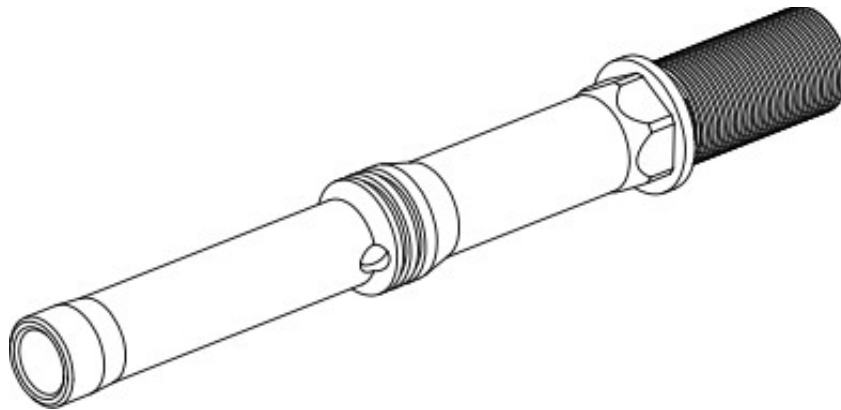

Steyr GB - 9x19 Threaded / Gewinde L=151 MM (5.9")

Caliber Kaliber	Profile Profil	Threading Gewinde	Order No. Artikelnr.	Price Preis
9x19	Polygonal	1/2x28	T08-P919-151-G01	A+A01
9x19	Hexagonal	1/2x28	T08-H919-151-G01	A+A01

More threadings on request / Mehr Gewinde auf Anfrage

Accessories / Zubehör

	Price / Preis
Model Shark	A09
Model Shark Compact	A09
Steel Thread Protector	A08

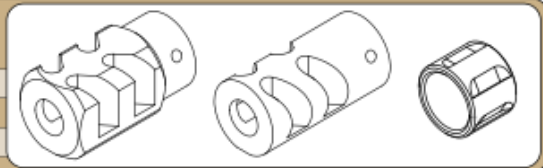

Add Custom Surface Oberflächenoptionen

	Price / Preis
PVD (Gold, Silver, Tan, Bronze, ...)	Base + A05
Sandblast / Sandgestrahlt	Base +A04
Twisted Fluted / Spiralgefütet	Base +A02
Straight Fluted / Geradegefütet	Base +A02

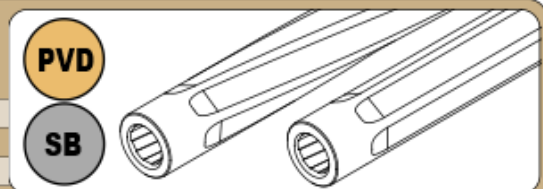

IGB BARRELS IDEAS

Make it YOUR Gun with the IGB Variety
 Machen Sie es zu IHRER Pistole mit den IGB Variationen.

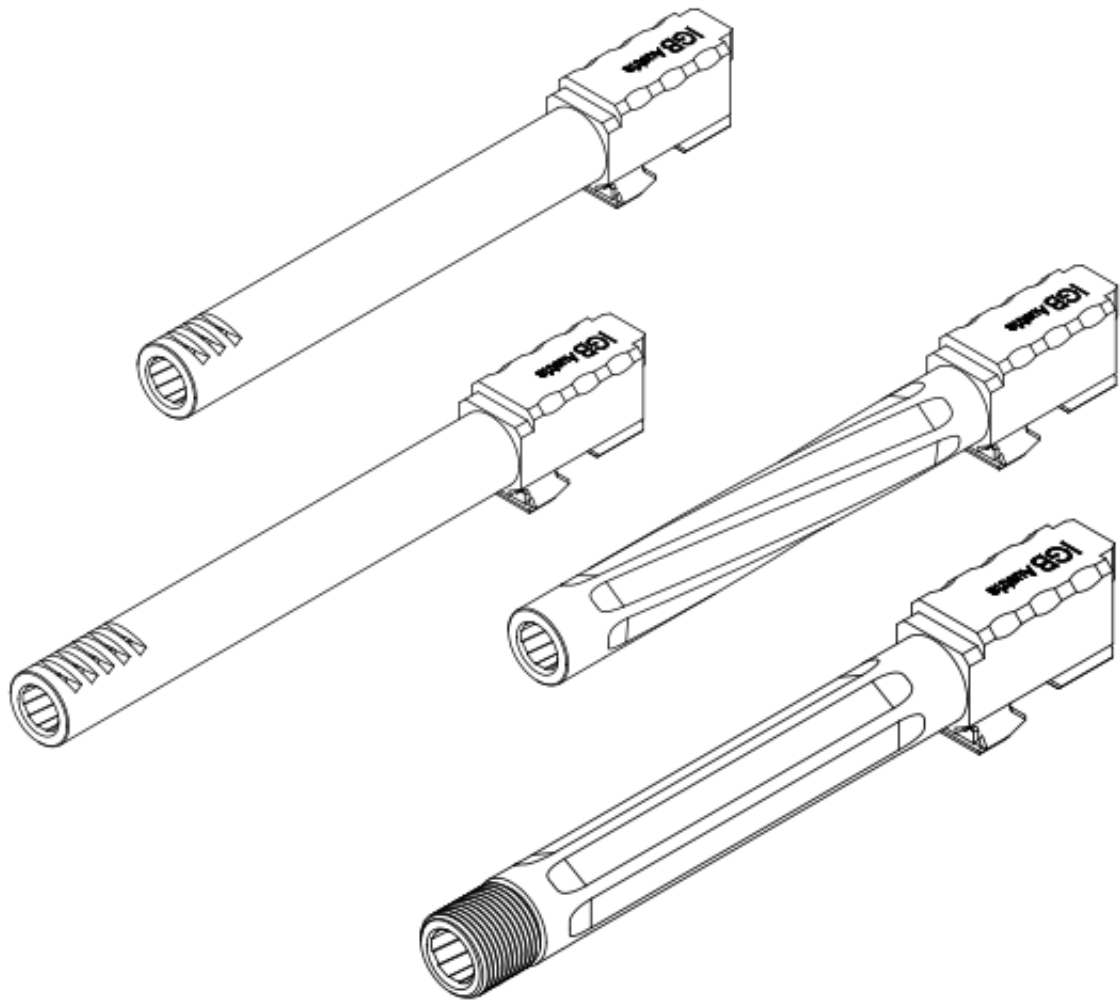

**Additional Options /
Zusätzliche Optionen**

	Price / Preis
Straight Fluted / Geradegeflutet	Base +A03
Twisted Fluted / Spiralgeflutet	Base +A03
3 Muzzleports / 3 Mündungsschlitze	Base +A02
5 Muzzleports / 5 Mündungsschlitze	Base +A02

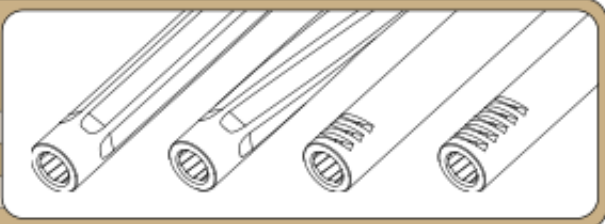

**Add Custom Surface
Oberflächenoptionen**

	Price / Preis
PVD (Gold, Silver, Tan, Bronze, ...)	Base + A05
Sandblast / Sandgestrahlt	Base +A04
Twisted Fluted / Spiralgeflutet	Base +A02
Straight Fluted / Geradegeflutet	Base +A02

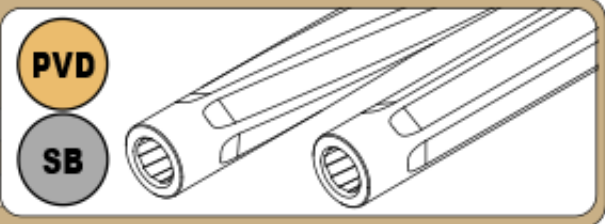

GLOCK CZ S&W SIG SAUER P210 1911 STEYR H&K FN ACCESSORY

GLOCK CZ S&W SIG SAUER P210 1911 STEYR H&K FN ACCESSORY

IGB BARRELS FOR HK

Heckler & Koch



IGB Austria

Barreltechnology

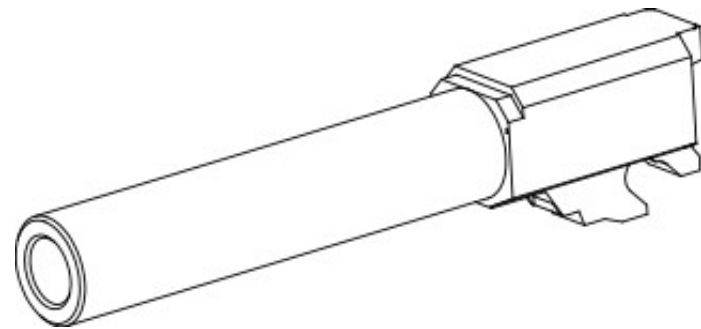
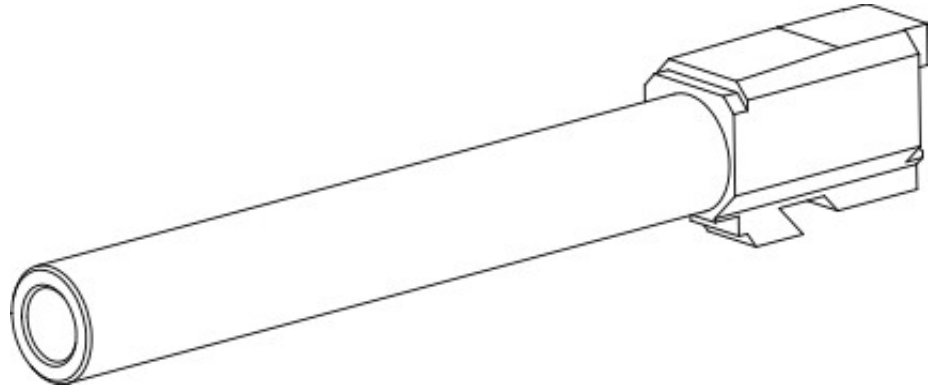

IGB BARRELS FOR HK



HK P30 - 9x19

HK P30 - 9x19 Standard Length (115 MM)

Order No. Artikelnr.	From Von	Inner Profile Innenprofil	To Zu	Length Länge	Price Preis
K03-P919-S115	9x19	Polygonal	9x19	115 MM	H
K03-H919-S115	9x19	Hexagonal	9x19	115 MM	H
K03-P921-S115	9x19	Polygonal	9x21	115 MM	H
K03-H765-S115	9x19	Hexagonal	7,65 Para	115 MM	H

HK P30 - 9x19 L=153 MM (6")

Order No. Artikelnr.	From Von	Inner Profile Innenprofil	To Zu	Length Länge	Price Preis
K03-P919-153	9x19	Polygonal	9x19	153 MM	I
K03-H919-153	9x19	Hexagonal	9x19	153 MM	I
K03-P921-153	9x19	Polygonal	9x21	153 MM	I
K03-H765-153	9x19	Hexagonal	7,65 Para	153 MM	I

HK P30 - 9x19 L=191 MM (7.5")

Order No. Artikelnr.	From Von	Inner Profile Innenprofil	To Zu	Length Länge	Price Preis
K03-P919-191	9x19	Polygonal	9x19	191 MM	J
K03-H919-191	9x19	Hexagonal	9x19	191 MM	J
K03-P921-191	9x19	Polygonal	9x21	191 MM	J

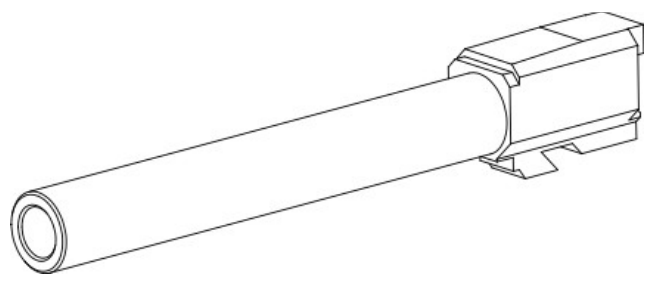

Additional Options / Zusätzliche Optionen	Price / Preis
Straight Fluted / Geradegeflutet	Base +A03
Twisted Fluted / Spiralgeflutet	Base +A03
3 Muzzleports / 3 Mündungsschlitze	Base +A02
5 Muzzleports / 5 Mündungsschlitze	Base +A02

IGB BARRELS FOR HK

HK P30



IGB Austria

HK P30 - 9x19 Threaded / Gewinde L=129 MM (5.1")

Caliber Kaliber	Profile Profil	Threading Gewinde	Order No. Artikelnr.	Threading Gewinde	Order No. Artikelnr.	Price Preis
9x19	Poly	1/2x28	K03-P919-129-G01	M13,5x1L	K03-P919-129-G04	H+A01
9x19	Hexa	1/2x28	K03-H919-129-G01	M13,5x1L	K03-H919-129-G04	H+A01
9x21	Poly	1/2x28	K03-P921-129-G01	M13,5x1L	K03-P921-129-G04	H+A01
7,65 Para	Hexa	1/2x28	K03-H765-129-G01	M13,5x1L	K03-H765-129-G04	H+A01

HK P30 - 9x19 Threaded / Gewinde L=129 MM (5.1")

Caliber Kaliber	Profile Profil	Threading Gewinde	Order No. Artikelnr.	Threading Gewinde	Order No. Artikelnr.	Price Preis
9x19	Poly	M13x1	K03-P919-129-G02	M14x1	K03-P919-129-G05	H+A01
9x19	Hexa	M13x1	K03-H919-129-G02	M14x1	K03-H919-129-G05	H+A01
9x21	Poly	M13x1	K03-P921-129-G02	M14x1	K03-P921-129-G05	H+A01
7,65 Para	Hexa	M13x1	K03-H765-129-G02	M14x1	K03-H765-129-G05	H+A01

More threadings on request / Mehr Gewinde auf Anfrage

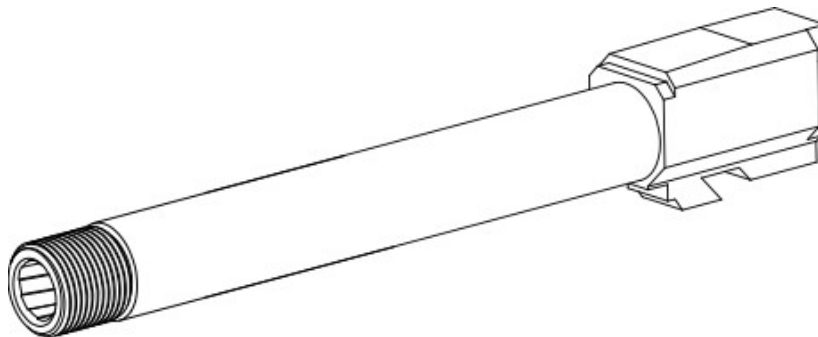

Accessories / Zubehör

	Price / Preis
Model Shark	A09
Model Shark Compact	A09
Steel Thread Protector	A08

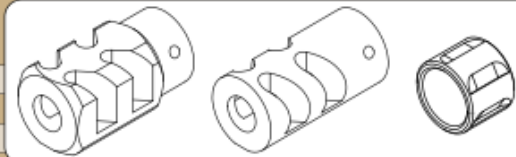

Add Custom Surface Oberflächenoptionen

	Price / Preis
PVD (Gold, Silver, Tan, Bronze, ...)	Base + A05
Sandblast / Sandgestrahlt	Base + A04
Twisted Fluted / Spiralgefütet	Base + A02
Straight Fluted / Geradegefütet	Base + A02

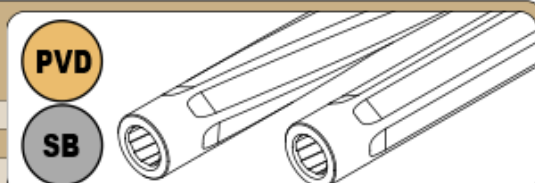

IGB BARRELS FOR HK



HK P2000 - 9x19

HK P2000 - 9x19 Standard Length (94 MM)

Order No. Artikelnr.	From Von	Inner Profile Innenprofil	To Zu	Length Länge	Price Preis
K06-P919-S094	9x19	Polygonal	9x19	94 MM	H
K06-H919-S094	9x19	Hexagonal	9x19	94 MM	H
K06-P921-S094	9x19	Polygonal	9x21	94 MM	H
K06-H765-S094	9x19	Hexagonal	7,65 Para	94 MM	H

HK P2000 - 9x19 L=153 MM (6")

Order No. Artikelnr.	From Von	Inner Profile Innenprofil	To Zu	Length Länge	Price Preis
K06-P919-153	9x19	Polygonal	9x19	153 MM	I
K06-H919-153	9x19	Hexagonal	9x19	153 MM	I
K06-P921-153	9x19	Polygonal	9x21	153 MM	I
K06-H765-153	9x19	Hexagonal	7,65 Para	153 MM	I

HK P2000 - 9x19 L=191 MM (7.5")

Order No. Artikelnr.	From Von	Inner Profile Innenprofil	To Zu	Length Länge	Price Preis
K06-P919-191	9x19	Polygonal	9x19	191 MM	J
K06-H919-191	9x19	Hexagonal	9x19	191 MM	J
K06-P921-191	9x19	Polygonal	9x21	191 MM	J

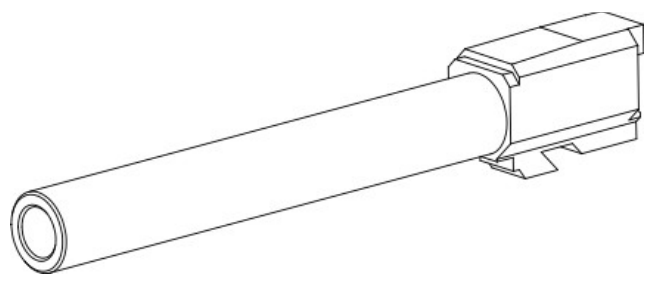

Additional Options / Zusätzliche Optionen	Price / Preis
Straight Fluted / Geradegeflutet	Base +A03
Twisted Fluted / Spiralgeflutet	Base +A03
3 Muzzleports / 3 Mündungsschlitze	Base +A02
5 Muzzleports / 5 Mündungsschlitze	Base +A02

IGB BARRELS FOR HK

HK P2000



IGB Austria

HK P2000 - 9x19 Threaded / Gewinde L=108 MM (4.3")

Caliber Kaliber	Profile Profil	Threading Gewinde	Order No. Artikelnr.	Threading Gewinde	Order No. Artikelnr.	Price Preis
9x19	Poly	1/2x28	K06-P919-108-G01	M13,5x1L	K06-P919-108-G04	H+A01
9x19	Hexa	1/2x28	K06-H919-108-G01	M13,5x1L	K06-H919-108-G04	H+A01
9x21	Poly	1/2x28	K06-P921-108-G01	M13,5x1L	K06-P921-108-G04	H+A01
7,65 Para	Hexa	1/2x28	K06-H765-108-G01	M13,5x1L	K06-H765-108-G04	H+A01

HK P2000 - 9x19 Threaded / Gewinde L=108 MM (4.3")

Caliber Kaliber	Profile Profil	Threading Gewinde	Order No. Artikelnr.	Threading Gewinde	Order No. Artikelnr.	Price Preis
9x19	Poly	M13x1	K06-P919-108-G02	M14x1	K06-P919-108-G05	H+A01
9x19	Hexa	M13x1	K06-H919-108-G02	M14x1	K06-H919-108-G05	H+A01
9x21	Poly	M13x1	K06-P921-108-G02	M14x1	K06-P921-108-G05	H+A01
7,65 Para	Hexa	M13x1	K06-H765-108-G02	M14x1	K06-H919-108-G05	H+A01

More threadings on request / Mehr Gewinde auf Anfrage

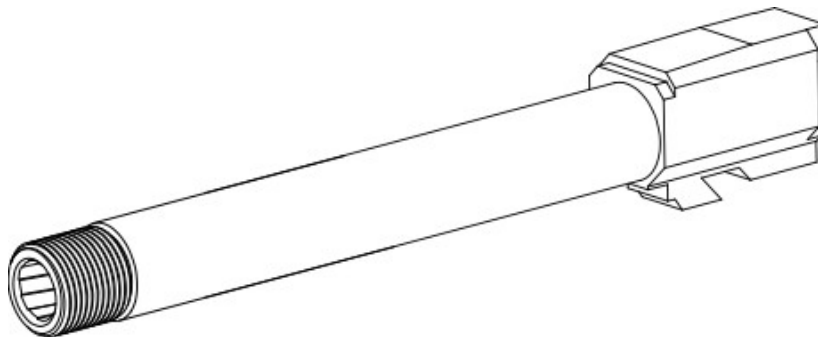

Accessories / Zubehör

	Price / Preis
Model Shark	A09
Model Shark Compact	A09
Steel Thread Protector	A08

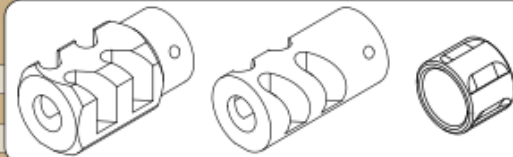

Add Custom Surface Oberflächenoptionen

	Price / Preis
PVD (Gold, Silver, Tan, Bronze, ...)	Base + A05
Sandblast / Sandgestrahlt	Base + A04
Twisted Fluted / Spiralgefütet	Base + A02
Straight Fluted / Geradegefütet	Base + A02

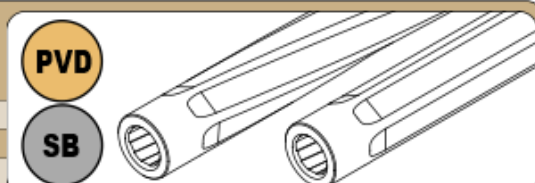

IGB BARRELS FOR HK



HK USP9 - 9x19

HK USP9 - 9x19 Standard Length (109 MM)

Order No. Artikelnr.	From Von	Inner Profile Innenprofil	To Zu	Length Länge	Price Preis
K10-P919-S109	9x19	Polygonal	9x19	109 MM	H
K10-H919-S109	9x19	Hexagonal	9x19	109 MM	H
K10-P921-S109	9x19	Polygonal	9x21	109 MM	H
K10-H765-S109	9x19	Hexagonal	7,65 Para	109 MM	H

HK USP9 - 9x19 L=153 MM (6")

Order No. Artikelnr.	From Von	Inner Profile Innenprofil	To Zu	Length Länge	Price Preis
K10-P919-153	9x19	Polygonal	9x19	153 MM	I
K10-H919-153	9x19	Hexagonal	9x19	153 MM	I
K10-P921-153	9x19	Polygonal	9x21	153 MM	I
K10-H765-153	9x19	Hexagonal	7,65 Para	153 MM	I

HK USP9 - 9x19 L=191 MM (7.5")

Order No. Artikelnr.	From Von	Inner Profile Innenprofil	To Zu	Length Länge	Price Preis
K10-P919-191	9x19	Polygonal	9x19	191 MM	J
K10-H919-191	9x19	Hexagonal	9x19	191 MM	J
K10-P921-191	9x19	Polygonal	9x21	191 MM	J

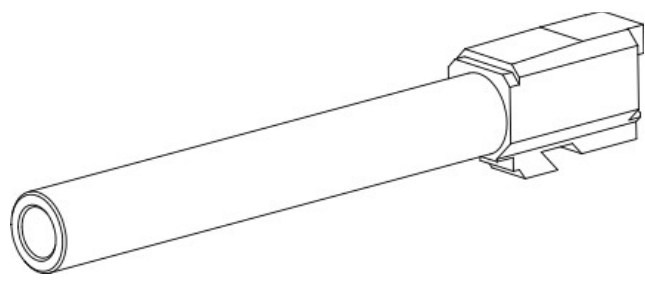

Additional Options / Zusätzliche Optionen	Price / Preis
Straight Fluted / Geradegeflutet	Base +A03
Twisted Fluted / Spiralgeflutet	Base +A03
3 Muzzleports / 3 Mündungsschlitze	Base +A02
5 Muzzleports / 5 Mündungsschlitze	Base +A02

IGB BARRELS FOR HK

HK USP9



IGB Austria

HK USP9 - 9x19 Threaded / Gewinde L=123 MM (4.8")

Caliber Kaliber	Profile Profil	Threading Gewinde	Order No. Artikelnr.	Threading Gewinde	Order No. Artikelnr.	Price Preis
9x19	Poly	1/2x28	K10-P919-123-G01	M13,5x1L	K10-P919-123-G04	H+A01
9x19	Hexa	1/2x28	K10-H919-123-G01	M13,5x1L	K10-H919-123-G04	H+A01
9x21	Poly	1/2x28	K10-P921-123-G01	M13,5x1L	K10-P921-123-G04	H+A01
7,65 Para	Hexa	1/2x28	K10-H765-123-G01	M13,5x1L	K10-H765-123-G04	H+A01

HK USP9 - 9x19 Threaded / Gewinde L=123 MM (4.8")

Caliber Kaliber	Profile Profil	Threading Gewinde	Order No. Artikelnr.	Threading Gewinde	Order No. Artikelnr.	Price Preis
9x19	Poly	M13x1	K10-P919-123-G02	M13x1L	K10-P919-123-G03	H+A01
9x19	Hexa	M13x1	K10-H919-123-G02	M13x1L	K10-H919-123-G03	H+A01
9x21	Poly	M13x1	K10-P921-123-G02	M13x1L	K10-P921-123-G03	H+A01
7,65 Para	Hexa	M13x1	K10-H765-123-G02	M13x1L	K10-H765-123-G03	H+A01

More threadings on request / Mehr Gewinde auf Anfrage

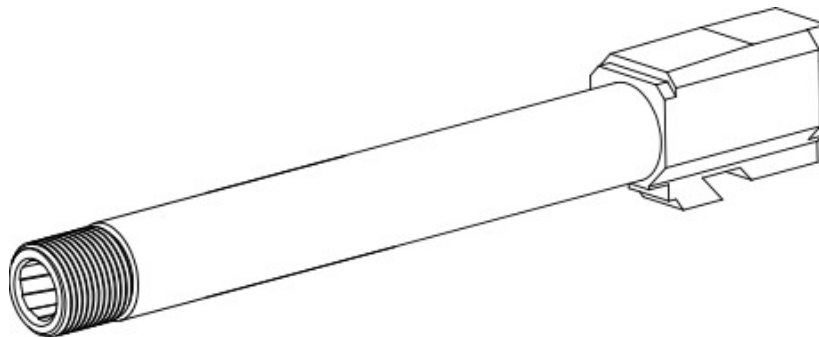

Accessories / Zubehör

	Price / Preis
Model Shark	A09
Model Shark Compact	A09
Steel Thread Protector	A08

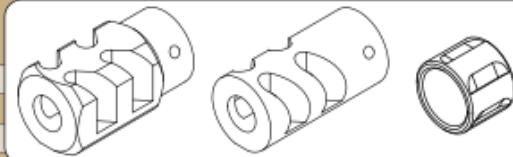

Add Custom Surface Oberflächenoptionen

	Price / Preis
PVD (Gold, Silver, Tan, Bronze, ...)	Base + A05
Sandblast / Sandgestrahlt	Base + A04
Twisted Fluted / Spiralgefütet	Base + A02
Straight Fluted / Geradegefütet	Base + A02

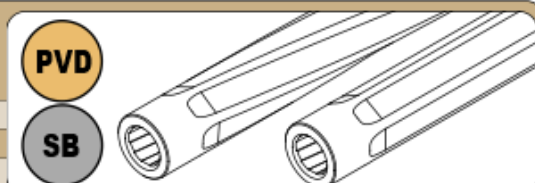

IGB BARRELS FOR HK



HK USP40 - .40 S&W

HK USP40 - .40 S&W Standard Length (109 MM)

Order No. Artikelnr.	From Von	Inner Profile Innenprofil	To Zu	Length Länge	Price Preis
K11-H040-S094	.40 S&W	Hexagonal	.40 S&W	109 MM	H
K11-H357-S094	.40 S&W	Hexagonal	.357 Sig	109 MM	H
K11-P357-S094	.40 S&W	Polygonal	.357 Sig	109 MM	H
K11-H919-S094	.40 S&W	Hexagonal	9x19*	109 MM	H
K11-P919-S094	.40 S&W	Polygonal	9x19*	109 MM	H

HK USP40 - .40 S&W L=153 MM (6")

Order No. Artikelnr.	From Von	Inner Profile Innenprofil	To Zu	Length Länge	Price Preis
K11-H040-153	.40 S&W	Hexagonal	.40 S&W	153 MM	I
K11-H357-153	.40 S&W	Hexagonal	.357 Sig	153 MM	I
K11-P357-153	.40 S&W	Polygonal	.357 Sig	153 MM	I
K11-H919-153	.40 S&W	Hexagonal	9x19*	153 MM	I
K11-P919-153	.40 S&W	Polygonal	9x19*	153 MM	I

HK USP40 - .40 S&W L=191 MM (7.5")

Order No. Artikelnr.	From Von	Inner Profile Innenprofil	To Zu	Length Länge	Price Preis
K11-H040-191	.40 S&W	Hexagonal	.40 S&W	191 MM	J
K11-H357-191	.40 S&W	Hexagonal	.357 Sig	191 MM	J
K11-P357-191	.40 S&W	Polygonal	.357 Sig	191 MM	J
K11-H919-191	.40 S&W	Hexagonal	9x19*	191 MM	J
K11-P919-191	.40 S&W	Polygonal	9x19*	191 MM	J

*9mm Magazine required / 9mm Magazin benötigt

Additional Options / Zusätzliche Optionen	Price / Preis
Straight Fluted / Geradegeflutet	Base +A03
Twisted Fluted / Spiralgeflutet	Base +A03
3 Muzzleports / 3 Mündungsschlitze	Base +A02
5 Muzzleports / 5 Mündungsschlitze	Base +A02

IGB BARRELS FOR HK

HK USP40



IGB Austria

HK USP40 - .40 S&W Threaded / Gewinde L=123 MM (4.8")

Caliber Kaliber	Profile Profil	Threading Gewinde	Order No. Artikelnr.	Threading Gewinde	Order No. Artikelnr.	Price Preis
.40 S&W	Hexa	1/2x28	K11-H040-123-G01	M13,5x1L	K11-H040-123-G04	H+A01
.357 Sig	Hexa	1/2x28	K11-H357-123-G01	M13,5x1L	K11-H357-123-G04	H+A01
.357 Sig	Poly	1/2x28	K11-P357-123-G01	M13,5x1L	K11-P357-123-G04	H+A01
9x19*	Hexa	1/2x28	K11-H919-123-G01	M13,5x1L	K11-H919-123-G04	H+A01
9x19*	Poly	1/2x28	K11-P919-123-G01	M13,5x1L	K11-P919-123-G04	H+A01

*9mm Magazine required / 9mm Magazin benötigt

HK USP40 - .40 S&W Threaded / Gewinde L=123 MM (4.8")

Caliber Kaliber	Profile Profil	Threading Gewinde	Order No. Artikelnr.	Threading Gewinde	Order No. Artikelnr.	Price Preis
.40 S&W	Hexa	M13x1	K11-H040-123-G02	M14x1	K11-H040-123-G05	H+A01
.357 Sig	Hexa	M13x1	K11-H357-123-G02	M14x1	K11-H357-123-G05	H+A01
.357 Sig	Poly	M13x1	K11-P357-123-G02	M14x1	K11-P357-123-G05	H+A01
9x19*	Hexa	M13x1	K11-H919-123-G02	M14x1	K11-H919-123-G05	H+A01
9x19*	Poly	M13x1	K11-P919-123-G02	M14x1	K11-P919-123-G05	H+A01

More threadings on request / Mehr Gewinde auf Anfrage

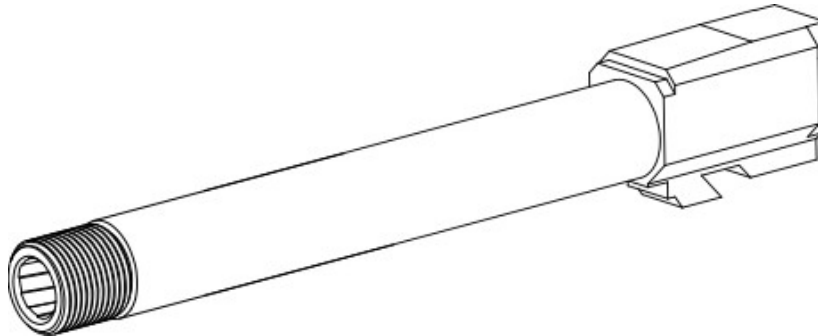

Accessories / Zubehör

	Price / Preis
Model Shark	A09
Model Shark Compact	A09
Steel Thread Protector	A08

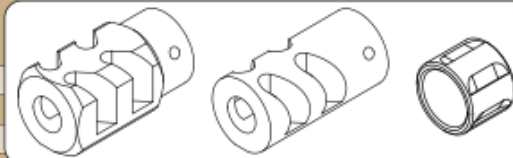

Add Custom Surface Oberflächenoptionen

	Price / Preis
PVD (Gold, Silver, Tan, Bronze, ...)	Base + A05
Sandblast / Sandgestrahlt	Base +A04
Twisted Fluted / Spiralgefütet	Base +A02
Straight Fluted / Geradegefütet	Base +A02

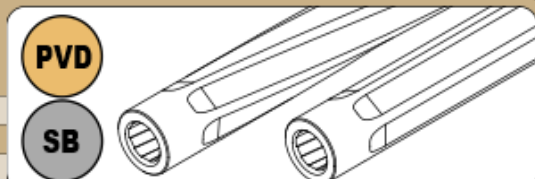

IGB BARRELS FOR HK



HK USP45 - .45 acp

HK USP45 - .45 acp Standard Length (114 MM)

Order No. Artikelnr.	From Von	Inner Profile Innenprofil	To Zu	Length Länge	Price Preis
K12-H045-S114	45 acp	Hexagonal	45 acp	114 MM	H
K12-H400-S114	45 acp	Hexagonal	.400 CorBon	114 MM	H

HK USP45 - .45 acp L=153 MM (6")

Order No. Artikelnr.	From Von	Inner Profile Innenprofil	To Zu	Length Länge	Price Preis
K12-H045-153	45 acp	Hexagonal	45 acp	153 MM	I
K12-H400-153	45 acp	Hexagonal	.400 CorBon	153 MM	I

HK USP45 - .45 acp L=191 MM (7.5")

Order No. Artikelnr.	From Von	Inner Profile Innenprofil	To Zu	Length Länge	Price Preis
K12-H045-191	45 acp	Hexagonal	45 acp	191 MM	J
K12-H400-191	45 acp	Hexagonal	.400 CorBon	191 MM	J

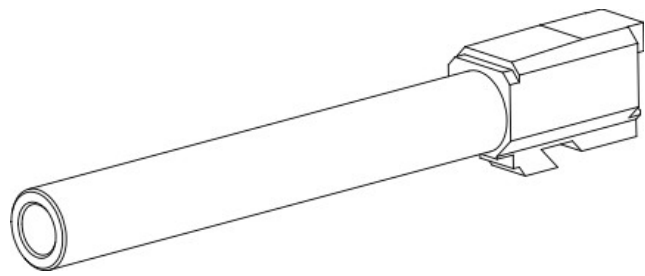

Additional Options / Zusätzliche Optionen	Price / Preis
Straight Fluted / Geradegeflutet	Base +A03
Twisted Fluted / Spiralgeflutet	Base +A03
3 Muzzleports / 3 Mündungsschlitze	Base +A02
5 Muzzleports / 5 Mündungsschlitze	Base +A02

IGB BARRELS FOR HK

HK USP45



IGB Austria

HK USP45 - .45 acp Threaded / Gewinde L=128 MM (5")

Caliber Kaliber	Profile Profil	Threading Gewinde	Order No. Artikelnr.	Threading Gewinde	Order No. Artikelnr.	Price Preis
45 acp	Hexa	M16x1	K12-H045-128-G09	M15x1	K12-H045-128-G07	H+A01
400 CrBn	Hexa	M16x1	K12-H400-128-G09	M15x1	K12-H400-128-G07	H+A01

HK USP45 - .45 acp Threaded / Gewinde L=128 MM (5")

Caliber Kaliber	Profile Profil	Threading Gewinde	Order No. Artikelnr.	Threading Gewinde	Order No. Artikelnr.	Price Preis
45 acp	Hexa	M16x1L	K12-H045-128-G10	M15x1L	K12-H045-128-G08	H+A01
400 CrBn	Hexa	M16x1L	K12-H400-128-G10	M15x1L	K12-H400-128-G08	H+A01

More threadings on request / Mehr Gewinde auf Anfrage

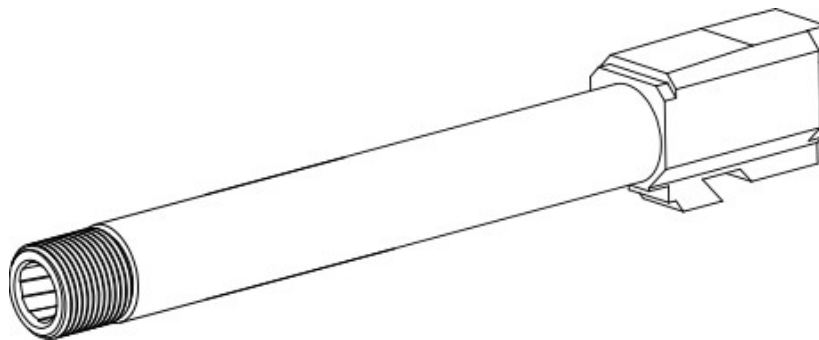

Accessories / Zubehör

	Price / Preis
Model Shark	A09
Model Shark Compact	A09
Steel Thread Protector	A08

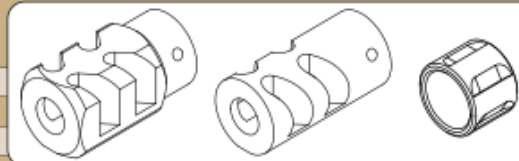

Add Custom Surface Oberflächenoptionen

	Price / Preis
PVD (Gold, Silver, Tan, Bronze, ...)	Base + A05
Sandblast / Sandgestrahlt	Base +A04
Twisted Fluted / Spiralgefütet	Base +A02
Straight Fluted / Geradegefütet	Base +A02

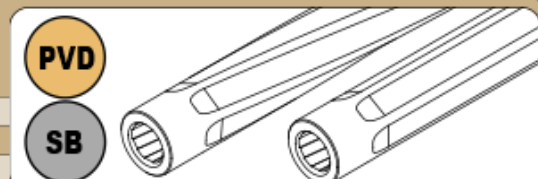

IGB BARRELS FOR HK



HK45 - .45 acp

HK45 - .45 acp Standard Length (114 MM)

Order No. Artikelnr.	From Von	Inner Profile Innenprofil	To Zu	Length Länge	Price Preis
K00-H045-S114	45 acp	Hexagonal	45 acp	114 MM	H
K00-H400-S114	45 acp	Hexagonal	.400 CorBon	114 MM	H

HK45 - .45 acp L=153 MM (6")

Order No. Artikelnr.	From Von	Inner Profile Innenprofil	To Zu	Length Länge	Price Preis
K00-H045-153	45 acp	Hexagonal	45 acp	153 MM	I
K00-H400-153	45 acp	Hexagonal	.400 CorBon	153 MM	I

HK45 - .45 acp L=191 MM (7.5")

Order No. Artikelnr.	From Von	Inner Profile Innenprofil	To Zu	Length Länge	Price Preis
K00-H045-191	45 acp	Hexagonal	45 acp	191 MM	J
K00-H400-191	45 acp	Hexagonal	.400 CorBon	191 MM	J

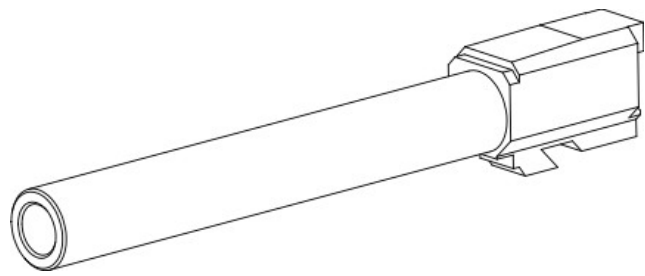

Additional Options / Zusätzliche Optionen	Price / Preis
Straight Fluted / Geradegeflutet	Base +A03
Twisted Fluted / Spiralgeflutet	Base +A03
3 Muzzleports / 3 Mündungsschlitze	Base +A02
5 Muzzleports / 5 Mündungsschlitze	Base +A02

IGB BARRELS FOR HK

HK 45



IGB Austria

HK45 - .45 acp Threaded / Gewinde L=128 MM (5")

Caliber Kaliber	Profile Profil	Threading Gewinde	Order No. Artikelnr.	Threading Gewinde	Order No. Artikelnr.	Price Preis
45 acp	Hexa	M16x1	K00-H045-128-G09	M15x1	K00-H045-128-G07	H+A01
400 CrBn	Hexa	M16x1	K00-H400-128-G09	M15x1	K00-H400-128-G07	H+A01

HK45 - .45 acp Threaded / Gewinde L=128 MM (5")

Caliber Kaliber	Profile Profil	Threading Gewinde	Order No. Artikelnr.	Threading Gewinde	Order No. Artikelnr.	Price Preis
45 acp	Hexa	M16x1L	K00-H045-128-G10	M15x1L	K00-H045-128-G08	H+A01
400 CrBn	Hexa	M16x1L	K00-H400-128-G10	M15x1L	K00-H400-128-G08	H+A01

More threadings on request / Mehr Gewinde auf Anfrage

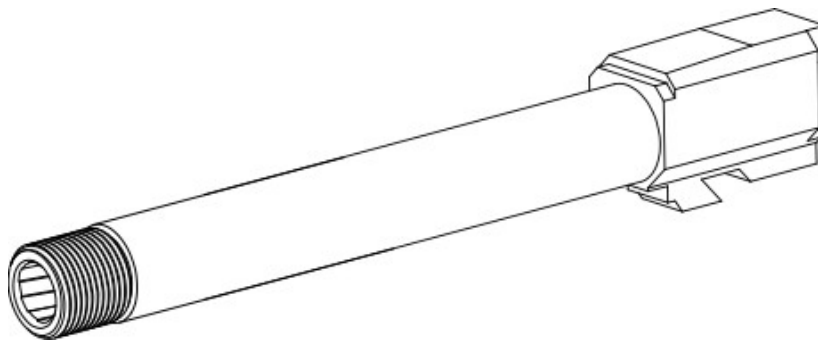

Accessories / Zubehör

	Price / Preis
Model Shark	A09
Model Shark Compact	A09
Steel Thread Protector	A08

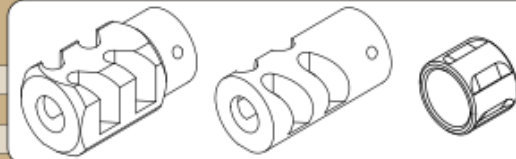

Add Custom Surface Oberflächenoptionen

	Price / Preis
PVD (Gold, Silver, Tan, Bronze, ...)	Base + A05
Sandblast / Sandgestrahlt	Base +A04
Twisted Fluted / Spiralgefütet	Base +A02
Straight Fluted / Geradegefütet	Base +A02

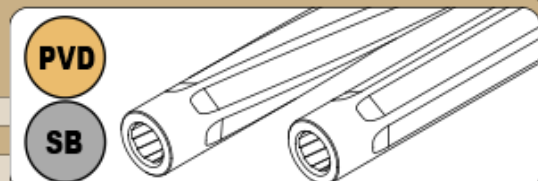

IGB BARRELS FOR HK

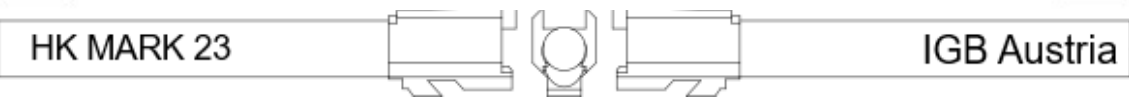

HK Mark 23 - .45 acp

HK Mark 23 - .45 acp Standard Length (138 MM)

Order No. Artikelnr.	From Von	Inner Profile Innenprofil	To Zu	Length Länge	Price Preis
K01-H045-S138	45 acp	Hexagonal	45 acp	138 MM	H
K01-H400-S138	45 acp	Hexagonal	.400 CorBon	138 MM	H

HK Mark 23 - .45 acp L=153 MM (6")

Order No. Artikelnr.	From Von	Inner Profile Innenprofil	To Zu	Length Länge	Price Preis
K01-H045-153	45 acp	Hexagonal	45 acp	153 MM	I
K01-H400-153	45 acp	Hexagonal	.400 CorBon	153 MM	I

HK Mark 23 - .45 acp L=191 MM (7.5")

Order No. Artikelnr.	From Von	Inner Profile Innenprofil	To Zu	Length Länge	Price Preis
K01-H045-191	45 acp	Hexagonal	45 acp	191 MM	J
K01-H400-191	45 acp	Hexagonal	.400 CorBon	191 MM	J

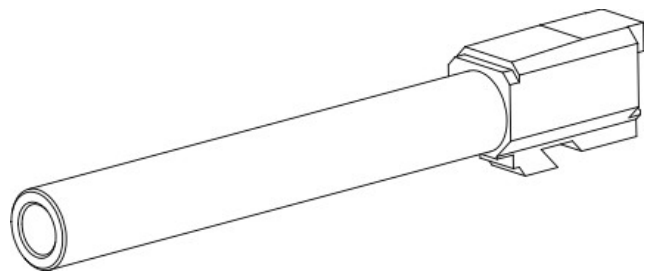

**Additional Options /
Zusätzliche Optionen**

	Price / Preis
Straight Fluted / Geradegeflutet	Base +A03
Twisted Fluted / Spiralgeflutet	Base +A03
3 Muzzleports / 3 Mündungsschlitze	Base +A02
5 Muzzleports / 5 Mündungsschlitze	Base +A02

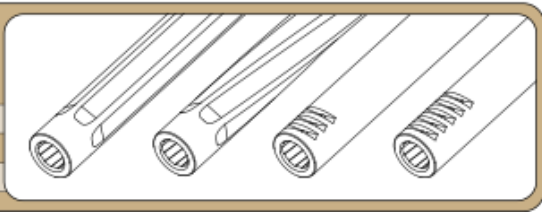

IGB BARRELS FOR HK

HK MARK 23



IGB Austria

HK Mark 23 - .45 acp Threaded / Gewinde L=152 MM (6")

Caliber Kaliber	Profile Profil	Threading Gewinde	Order No. Artikelnr.	Threading Gewinde	Order No. Artikelnr.	Price Preis
45 acp	Hexa	M16x1	K01-H045-152-G09	M15x1	K01-H045-152-G07	H+A01
400 CrBn	Hexa	M16x1	K01-H400-152-G09	M15x1	K01-H400-152-G07	H+A01

HK Mark 23 - .45 acp Threaded / Gewinde L=152 MM (6")

Caliber Kaliber	Profile Profil	Threading Gewinde	Order No. Artikelnr.	Threading Gewinde	Order No. Artikelnr.	Price Preis
45 acp	Hexa	M16x1L	K01-H045-152-G10	M15x1L	K01-H045-152-G08	H+A01
400 CrBn	Hexa	M16x1L	K01-H400-152-G10	M15x1L	K01-H400-152-G08	H+A01

More threadings on request / Mehr Gewinde auf Anfrage

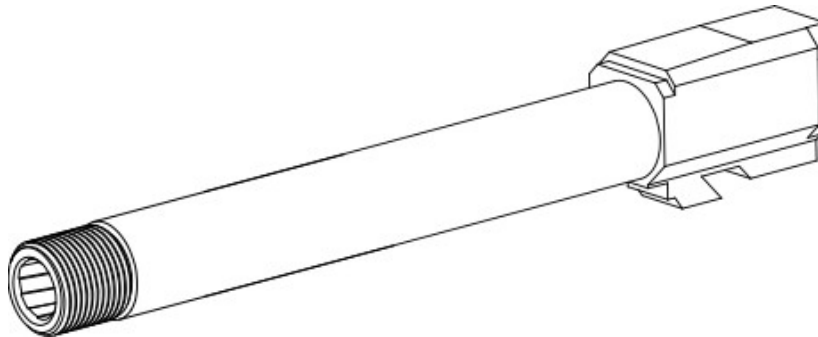

Accessories / Zubehör

	Price / Preis
Model Shark	A09
Model Shark Compact	A09
Steel Thread Protector	A08

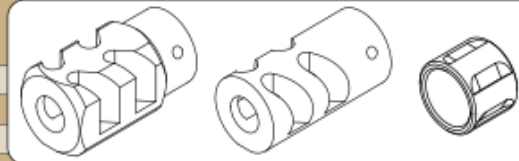

Add Custom Surface Oberflächenoptionen

	Price / Preis
PVD (Gold, Silver, Tan, Bronze, ...)	Base + A05
Sandblast / Sandgestrahlt	Base +A04
Twisted Fluted / Spiralgefütet	Base +A02
Straight Fluted / Geradegefütet	Base +A02

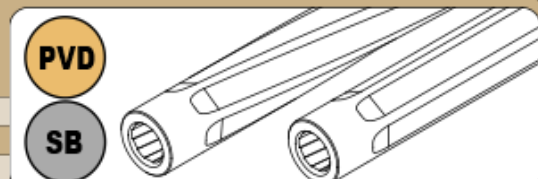

IGB BARRELS FOR HK

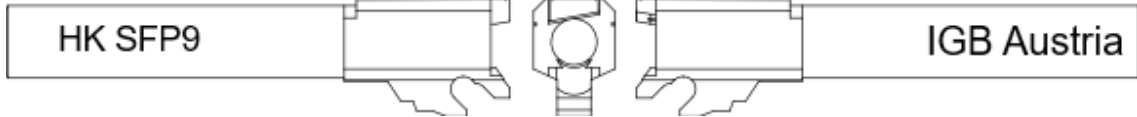

HK SFP9 - 9x19

HK SFP9 - 9x19 Standard Length (105 MM)

Order No. Artikelnr.	From Von	Inner Profile Innenprofil	To Zu	Length Länge	Price Preis
K20-P919-S105	9x19	Polygonal	9x19	105 MM	H
K20-H919-S105	9x19	Hexagonal	9x19	105 MM	H
K20-P921-S105	9x19	Polygonal	9x21	105 MM	H
K20-H765-S105	9x19	Hexagonal	7,65 Para	105 MM	H

HK SFP9 - 9x19 L=153 MM (6")

Order No. Artikelnr.	From Von	Inner Profile Innenprofil	To Zu	Length Länge	Price Preis
K20-P919-153	9x19	Polygonal	9x19	153 MM	I
K20-H919-153	9x19	Hexagonal	9x19	153 MM	I
K20-P921-153	9x19	Polygonal	9x21	153 MM	I
K20-H765-153	9x19	Hexagonal	7,65 Para	153 MM	I

HK SFP9 - 9x19 L=191 MM (7.5")

Order No. Artikelnr.	From Von	Inner Profile Innenprofil	To Zu	Length Länge	Price Preis
K20-P919-191	9x19	Polygonal	9x19	191 MM	J
K20-H919-191	9x19	Hexagonal	9x19	191 MM	J
K20-P921-191	9x19	Polygonal	9x21	191 MM	J

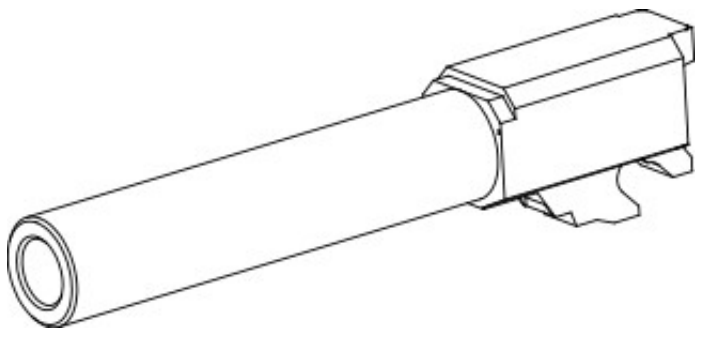

Additional Options / Zusätzliche Optionen	Price / Preis
Straight Fluted / Geradegeflutet	Base +A03
Twisted Fluted / Spiralgeflutet	Base +A03
3 Muzzleports / 3 Mündungsschlitze	Base +A02
5 Muzzleports / 5 Mündungsschlitze	Base +A02

IGB BARRELS FOR HK

HK SFP9

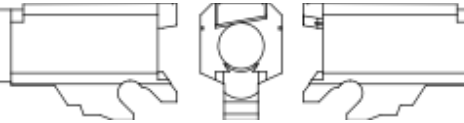

IGB Austria

HK SFP9 - 9x19 Threaded / Gewinde L=119 MM (4.7")

Caliber Kaliber	Profile Profil	Threading Gewinde	Order No. Artikelnr.	Threading Gewinde	Order No. Artikelnr.	Price Preis
9x19	Poly	1/2x28	K20-P919-119-G01	M13,5x1L	K20-P919-119-G04	H+A01
9x19	Hexa	1/2x28	K20-H919-119-G01	M13,5x1L	K20-H919-119-G04	H+A01
9x21	Poly	1/2x28	K20-P921-119-G01	M13,5x1L	K20-P921-119-G04	H+A01
7,65 Para	Hexa	1/2x28	K20-H765-119-G01	M13,5x1L	K20-H765-119-G04	H+A01

HK SFP9 - 9x19 Threaded / Gewinde L=119 MM (4.7")

Caliber Kaliber	Profile Profil	Threading Gewinde	Order No. Artikelnr.	Threading Gewinde	Order No. Artikelnr.	Price Preis
9x19	Poly	M13x1	K20-P919-119-G02	M13x1L	K20-P919-119-G03	H+A01
9x19	Hexa	M13x1	K20-H919-119-G02	M13x1L	K20-H919-119-G03	H+A01
9x21	Poly	M13x1	K20-P921-119-G02	M13x1L	K20-P921-119-G03	H+A01
7,65 Para	Hexa	M13x1	K20-H765-119-G02	M13x1L	K20-H765-119-G03	H+A01

More threadings on request / Mehr Gewinde auf Anfrage

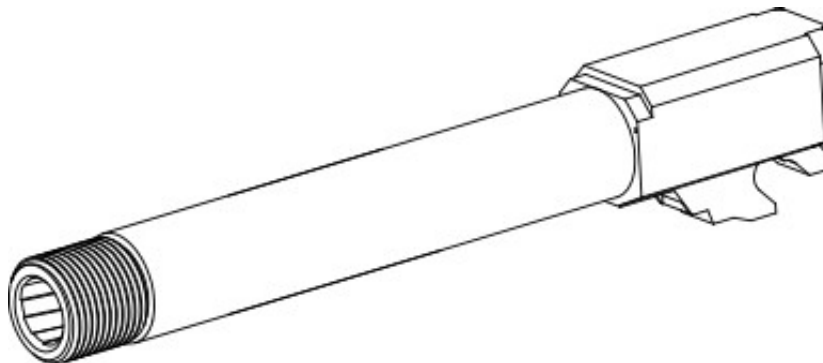

Accessories / Zubehör

	Price / Preis
Model Shark	A09
Model Shark Compact	A09
Steel Thread Protector	A08

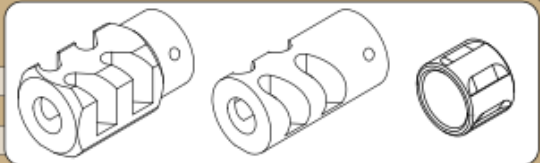

Add Custom Surface Oberflächenoptionen

	Price / Preis
PVD (Gold, Silver, Tan, Bronze, ...)	Base + A05
Sandblast / Sandgestrahlt	Base +A04
Twisted Fluted / Spiralgefütet	Base +A02
Straight Fluted / Geradegefütet	Base +A02

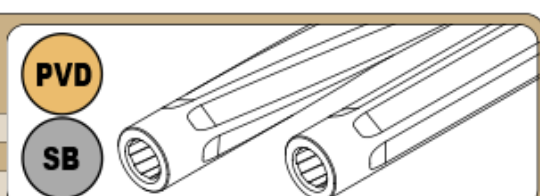

IGB BARRELS IDEAS

Make it YOUR Gun with the IGB Variety
 Machen Sie es zu IHRER Pistole mit den IGB Variationen.

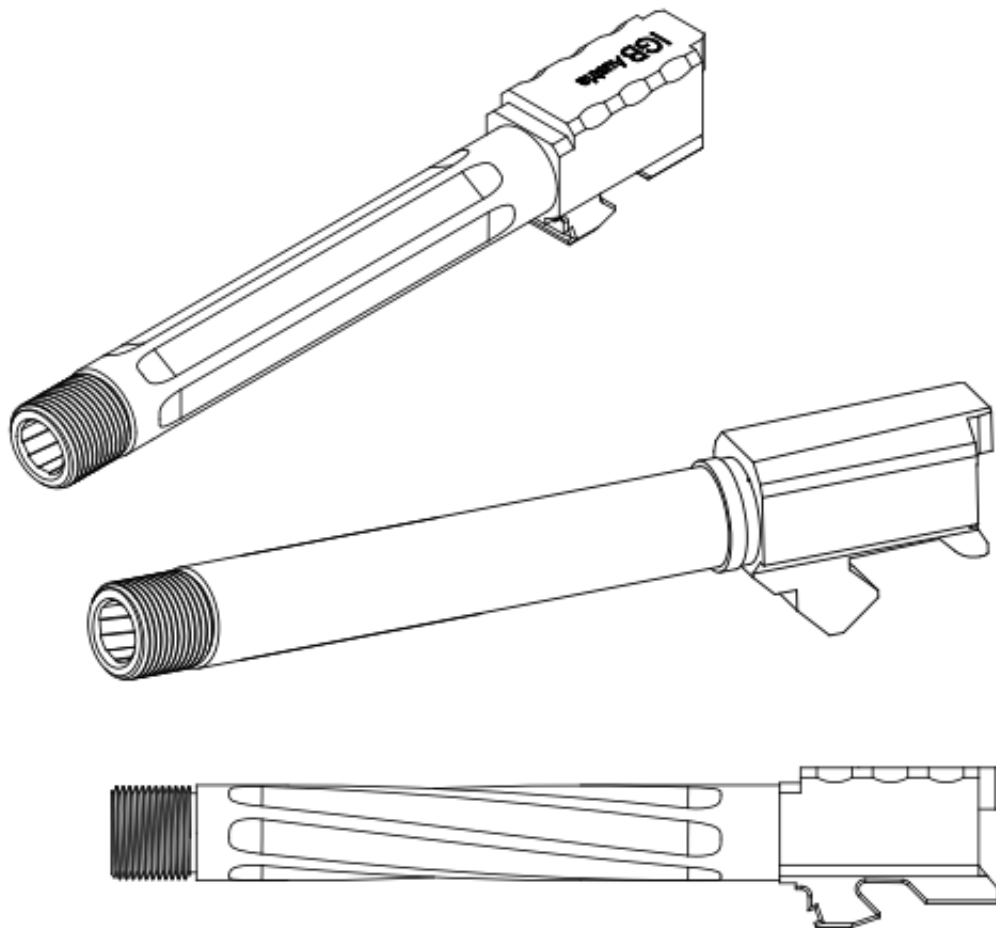

Accessories / Zubehör

	Price / Preis
Model Shark	A09
Model Shark Compact	A09
Steel Thread Protector	A08

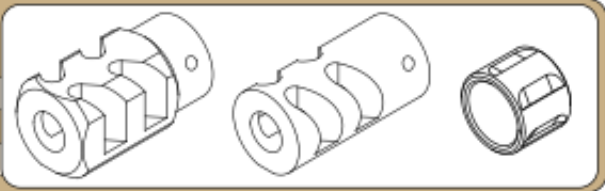

Add Custom Surface Oberflächenoptionen

	Price / Preis
PVD (Gold, Silver, Tan, Bronze, ...)	Base + A05
Sandblast / Sandgestrahlt	Base +A04
Twisted Fluted / Spiralfelutet	Base +A02
Straight Fluted / Geradegefütet	Base +A02

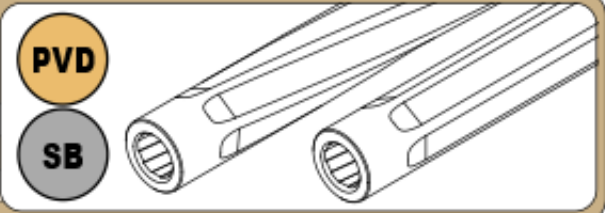

PVD

SB

IGB BARRELS FOR FN

FN



IGB Austria

Barreltechnology

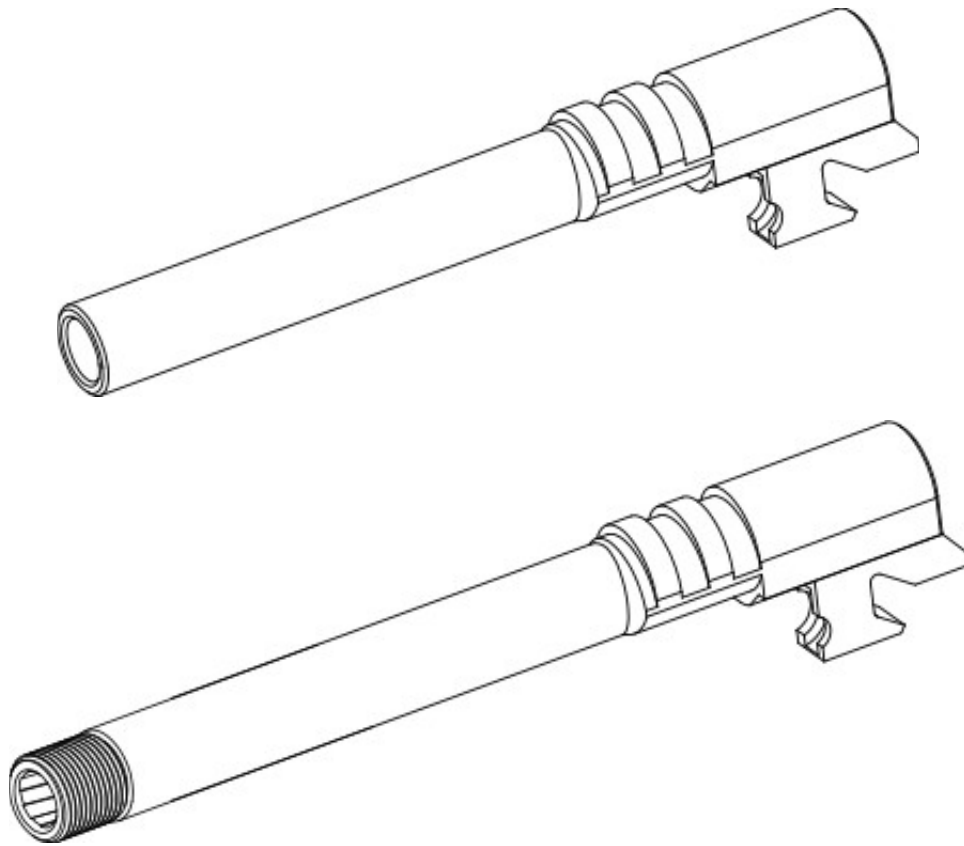

IGB BARRELS FOR FN

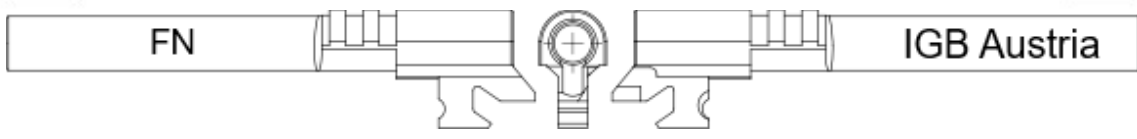

FN HP – 9x19

FN High Power Standard Length (124 MM)

Order No. Artikelnr.	From Von	Inner Profile Innenprofil	To Zu	Length Länge	Price Preis
N01-P919-S124	9x19	Polygonal	9x19	124 MM	G
N01-H919-S124	9x19	Hexagonal	9x19	124 MM	G

FN High Power Extended 153 MM (6")

Order No. Artikelnr.	From Von	Inner Profile Innenprofil	To Zu	Length Länge	Price Preis
N01-P919-153	9x19	Polygonal	9x19	153 MM	P
N01-H919-153	9x19	Hexagonal	9x19	153 MM	P

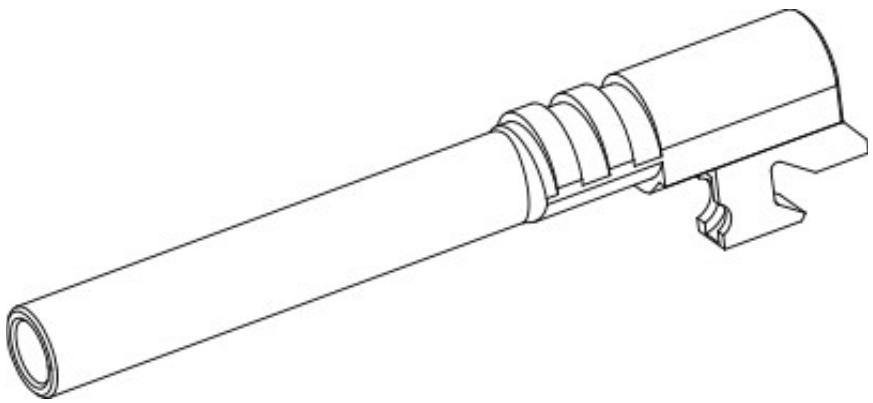

Polygonal vs Hexagonal

Polygonal is very smooth inside and therefore very gastight for high velocity.
 Polygonal ist formbedingt sehr Gasdicht für hohe Geschwindigkeiten.

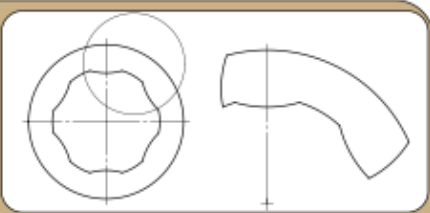
Hexagonal is the more classic approach and also well suited for pure lead.
 Hexagonal ist der klassischere Ansatz und gut geeignet für reine Bleigeschoße.

IGB BARRELS FOR FN

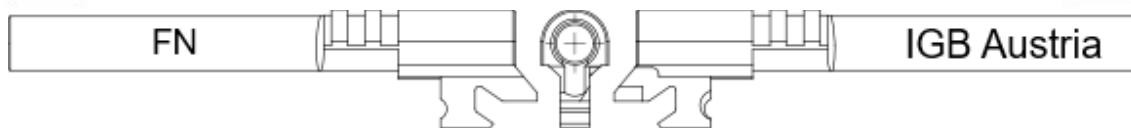

FN High Power Threaded / Gewinde Length 138 MM (5.4“)

Order No. Artikelnr.	From Von	Inner Profile Innenprofil	Threading Gewinde	Length Länge	Price Preis
N01-P919-138-G01	9x19	Polygonal	1/2x28	138 MM	G+A01
N01-H919-138-G01	9x19	Hexagonal	1/2x28	138 MM	G+A01

FN High Power Threaded / Gewinde Length 138 MM (5.4“)

Order No. Artikelnr.	From Von	Inner Profile Innenprofil	To Zu	Length Länge	Price Preis
N01-P919-138-G02	9x19	Polygonal	M13x1	138 MM	G+A01
N01-H919-138-G02	9x19	Hexagonal	M13x1	138 MM	G+A01

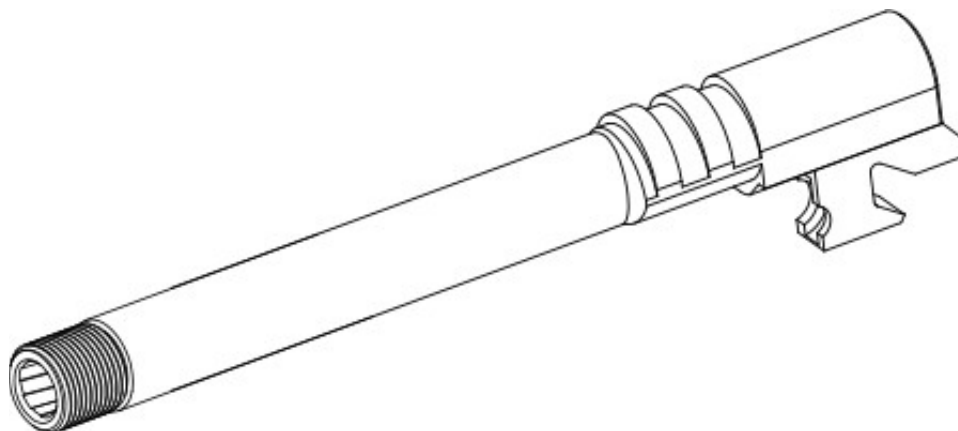

More threadings on request / Mehr Gewinde auf Anfrage

Accessories / Zubehör

	Price / Preis
Model Shark	A09
Model Shark Compact	A09
Steel Thread Protector	A08

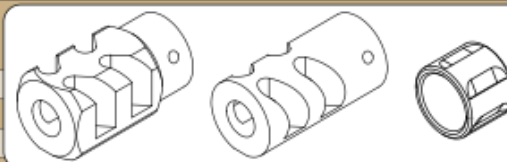

Add Custom Surface Oberflächenoptionen

	Price / Preis
PVD (Gold, Silver, Tan, Bronze, ...)	Base + A05
Sandblast / Sandgestrahlt	Base +A04
Twisted Fluted / Spiralgefütet	Base +A02
Straight Fluted / Geradegefütet	Base +A02

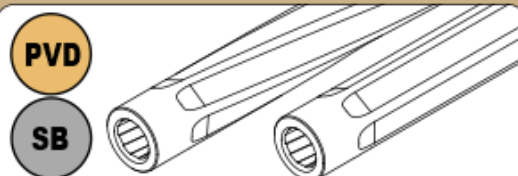

IGB BARRELS IDEAS

Make it YOUR Gun with the IGB Variety
 Machen Sie es zu IHRER Pistole mit den IGB Variationen.

Add Custom Surface Oberflächenoptionen

	Price / Preis
PVD (Gold, Silver, Tan, Bronze, ...)	Base + A05
Sandblast / Sandgestrahlt	Base +A04
Twisted Fluted / Spiralgeflutet	Base +A02
Straight Fluted / Geradegeflutet	Base +A02

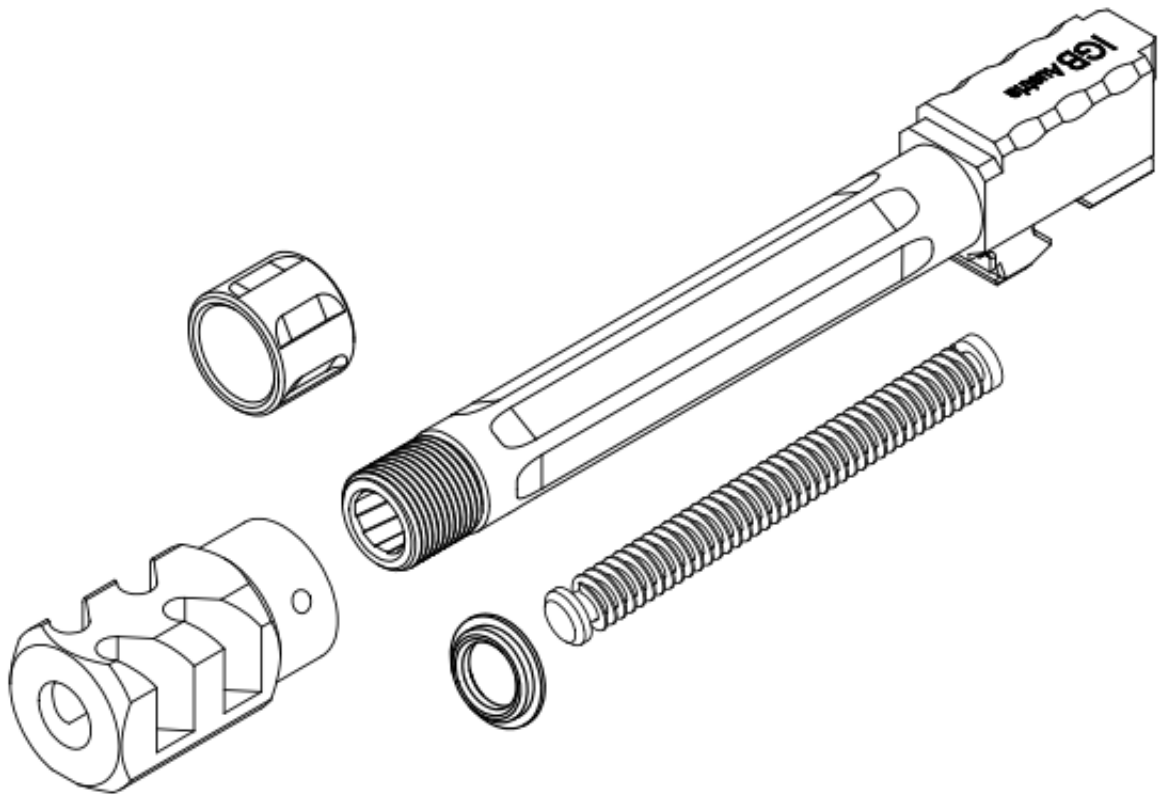
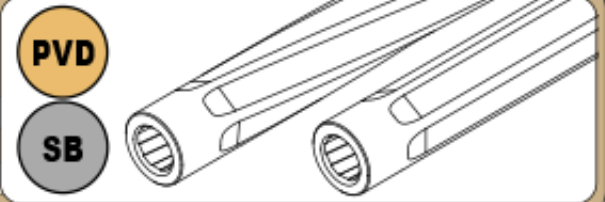

Polygonal vs Hexagonal

Polygonal is very smooth inside and therefore very gastight for high velocity.
 Polygonal ist formbedingt sehr Gasdicht für hohe Geschwindigkeiten.

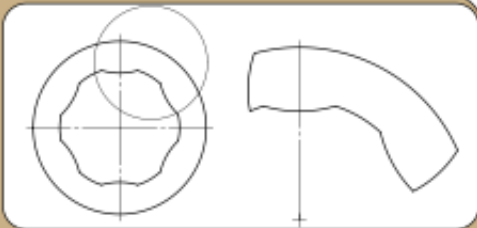
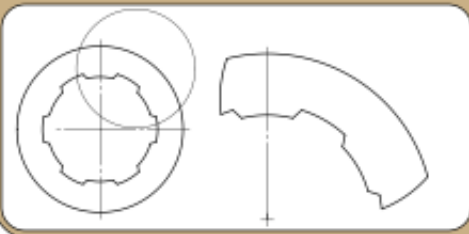

Hexagonal is the more classic approach and also well suited for pure led.
 Hexagonal ist der klassischere Ansatz und gut geeignet für reine Bleigeschöße.

Accessories



IGB Austria

Barreltechnology

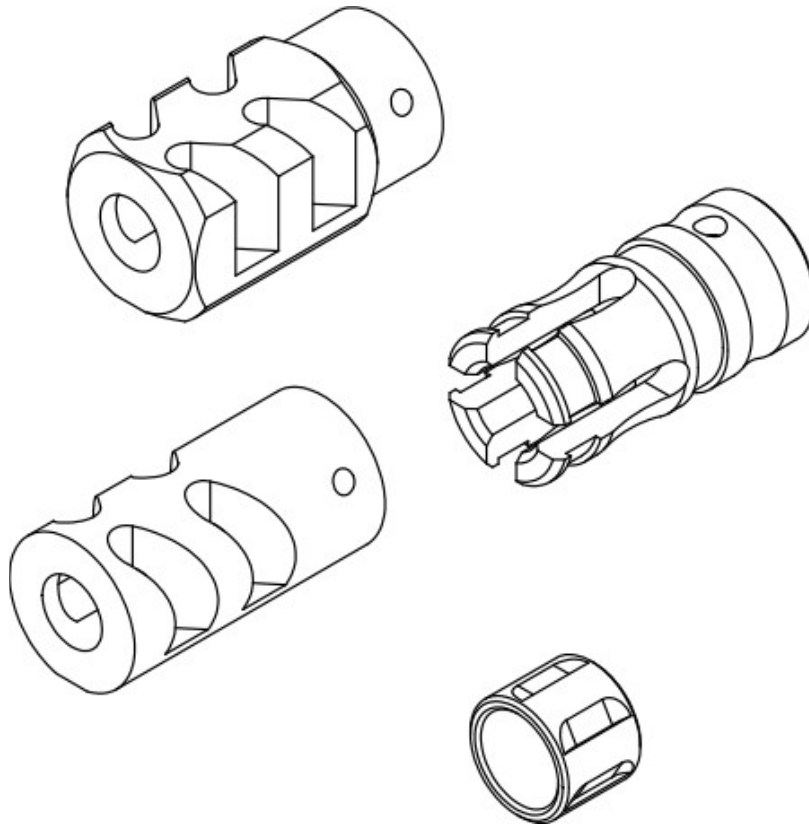

IGB ACCESSORIES

Compensator Shark / Kompensator Shark

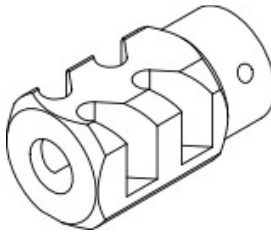
	Threading Gewinde	Ordernumber Bestellnummer	Price Preis
	1/2x28	KS-01	A09
	M13x1	KS-02	A09
	13,5x1L	KS-04	A09
	M14x1	KS-05	A09
	M15x1	KS-07	A09

Compensator Shark Compact / Kompensator Shark Compact

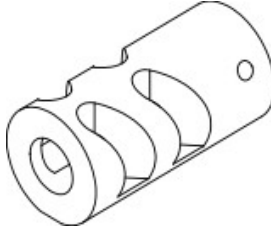
	Threading Gewinde	Ordernumber Bestellnummer	Price Preis
	1/2x28	KM-01	A09
	M13x1	KM-02	A09
	13,5x1L	KM-04	A09
	M14x1	KM-05	A09
	M15x1	KM-07	A09

Frequency Converter / Schwingungsdämpfer

	Threading Gewinde	Ordernumber Bestellnummer	Price Preis
	1/2x28	KD-01	A09
	M13x1	KD-02	A09
	13,5x1L	KD-04	A09
	M14x1	KD-05	A09
	M15x1	KD-07	A09

Adaptor Gen 3 to Gen 4 / Adapterring Gen 3 zu Gen 4

	Ordernumber Bestellnummer	Price Preis
	Z-G4	A11

Add Custom Surface Oberflächenoptionen

	Price / Preis
PVD (Gold, Silver, Tan, Bronze, ...)	Base + A05
Sandblast / Sandgestrahlt	Base + A04
Twisted Fluted / Spiralgefütet	Base + A02
Straight Fluted / Geradegefütet	Base + A02

PVD

SB

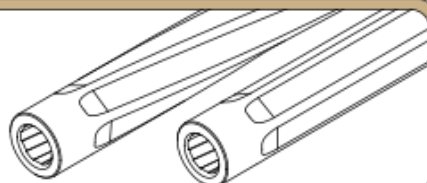

Threadprotector Steel Black* / Gewindeschutz Stahl Schwarz*



Threading Gewinde	Ordernummer Bestellnummer	Price Preis
1/2x28	GS-01	A08
M13x1	GS-02	A08
13,5x1L	GS-04	A08
M14x1	GS-05	A08
M15x1	GS-07	A08
M16x1	GS-10	A08

*Also available PVD coated or sandblasted / Auch PVD beschichtet oder sandgestrahlt erhältlich

Spring Set for Compensator / Federnset für Kompensator

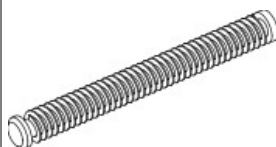

Pistol Model Pistolenmodell	Ordernummer Bestellnummer	Price Preis
G17 / 22 Gen 3	FFS-173	A11
G17 / 22 Gen4	FFS-174	A11
G17 / 22 Gen5	FFS-175	A11
G19 / 23 / 32 Gen3	FFS-193	A11
G19 / 23 / 32 Gen4 / 5	FFS-194	A11
G20 / 21 Gen3 / 4	FFS-203	A11

Shroud for GX Barrels / Laufmantel für GX Läufe

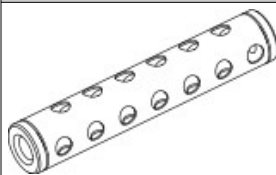

Length for Länge für	Threading Gewinde	Ordernummer Bestellnummer	Price Preis
255 MM	1/2x28	LP-9P-255	A12
410 MM	1/2x28	LP-9P-410	A13
410 MM	M15x1	LP-45-410	A13

Glock Magazine / Glockmagazin



Caliber Kaliber	Size Größe	Ordernummer Bestellnummer	Price Preis
9x19	fullsize	M09FS	A07
9x19	compact	M09CS	A07
40 / 357	fullsize	M40FS	A07
40 / 357	compact	M40CS	A07
10 Auto	fullsize	M10FS	A07

IGB AUSTRIA - GUIDE Threadings

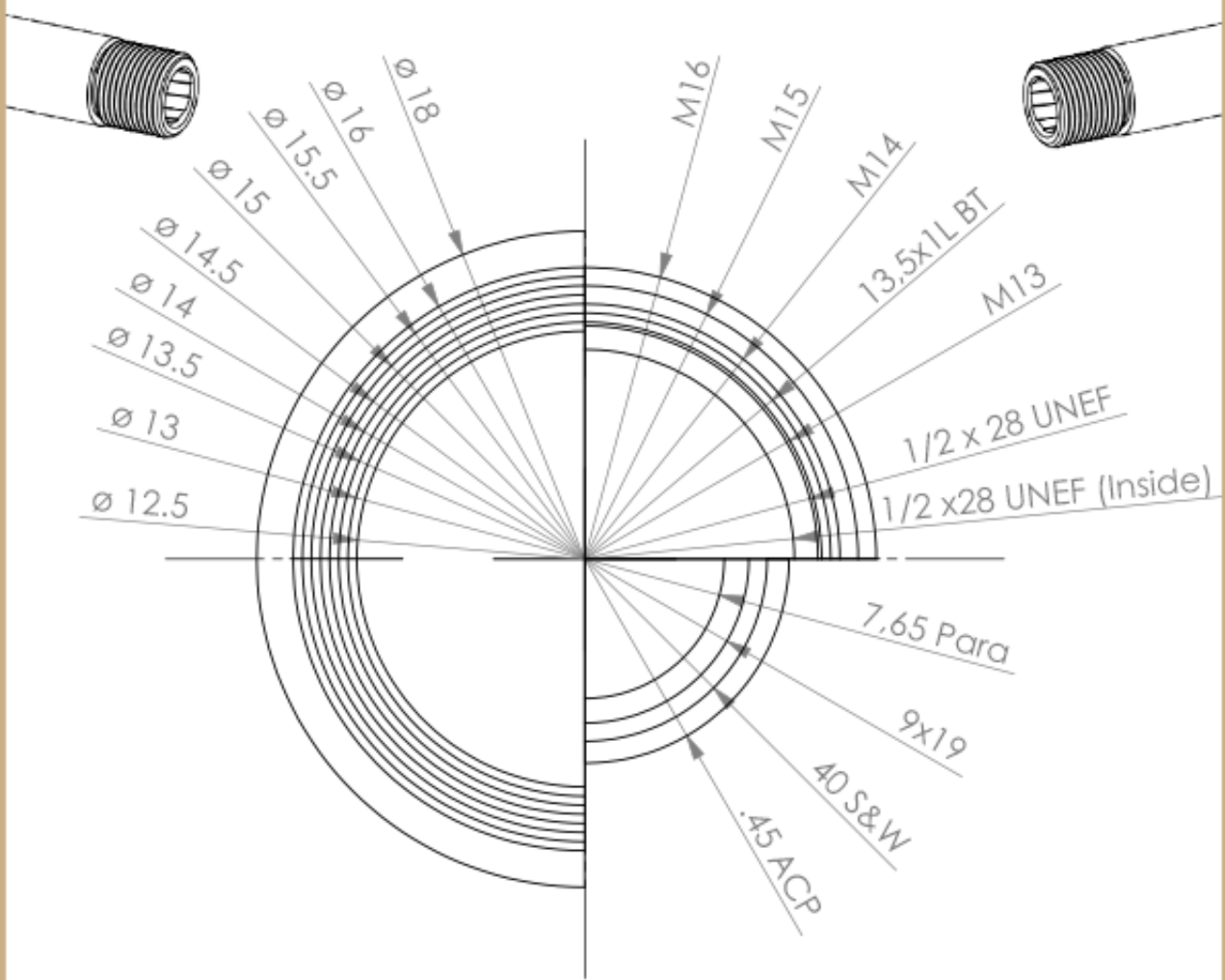

Threadings / Gewinde

Not all calibers support all threadings.
 Not all diameters support all threadings.

Example: $\frac{1}{2}$ x 28 UNEF does not fit a 12.5 mm barrel
 M15 is too big for a 14.5 mm barrel
 .45 ACP is too big for $\frac{1}{2}$ x 28 UNEF

Nicht alle Kaliber sind für gewisse Gewinde geeignet.
 Nicht alle Durchmesser sind für alle Gewinde geeignet.

Beispiel: $\frac{1}{2}$ x 28 UNEF passt nicht auf einen 12.5 mm Lauf
 M15 ist zu groß für einen 14.5 mm Lauf
 .45 ACP ist zu groß für $\frac{1}{2}$ x 28 UNEF